

## TABLE OF CONTENTS

I.	HISTORICAL BACKGROUND .....	1
II.	DESCRIPTION AND DATA .....	7
III.	MECHANICAL TRAINING	
	Section 1, Disassembly and Assembly .....	13
	Section 2, How the Carbine Functions .....	24
	Section 3, Operation .....	30
	Section 4, Immediate Action and Stoppages .....	32
	Section 5, Care and Cleaning .....	32
	Table I: Stoppages and Malfunctions .....	33
	Section 6, Spare Parts, Appendages and Accessories .....	39
	Section 7, Ammunition .....	40
IV.	INSPECTION	
	Section 1, General .....	43
	Section 2, Technical Inspection .....	44
	Table II: Inspection Guide .....	45
	Table III, Trouble Shooting .....	52
V.	REPAIR AND REBUILD	
	Section 1, General .....	55
	Section 2, Rebuild Flow Chart .....	58
	Table IV: Operations Route Sheet .....	59
	Section 3, Trigger Housing Group, Carbines M1, M1A1 .....	62
	Section 4, Trigger Housing Group, Carbines M2, M3 .....	67
	Section 5, Operating Slide Assembly .....	69
	Section 6, Bolt Group .....	72
	Section 7, Front Sight Assembly .....	73
	Section 8, Rear Sight Assembly .....	75
	Section 9, Barrel and Receiver Group .....	79
	Section 10, Stock Group, Carbines M1, M2, M3 .....	90
	Section 11, Stock Group, Carbine M1A1 .....	94
	Section 12, Magazine Assembly .....	98
VI.	FINAL INSPECTION .....	101
	Addendum, Targeting Requirements .....	102



---

## I. Historical Background

---

Although the term carbine is almost as old as shoulder weapons themselves, the concept of a military weapon designed from the start as a carbine is uniquely Twentieth Century, as are the airplane, submarine, missile-armed satellites and neutron bombs.

One of the earliest references to the term carbine and its possible origin appeared in 1548. According to that source, the word derived from the short barreled rifles carried by Spanish cavalry groups which were then called "Carabins". If this is true, the term would be appropriate since the carbine has, until just recently, been uniquely a cavalry weapon. While there has been a trend toward shorter barrels on military rifles for the last century and a half or so, the practice of issuing rifles with barrels as long as 30" was quite common even up through World War I. The M1903A3 Springfield, for example, had the shortest barrel of any standard issue shoulder arm during that conflict. Its 24" tube may be long by today's standards, but it was considerably shorter than the M1891 Mosin-Nagant's 31.6" or the French Lebel M1886's 31.4". Although called a rifle, the M1886 M93R35 was a true carbine with its 17.7" barrel. However, we can't help but wonder just how effective it was in combat, since it had only a three round magazine.

While it is obvious that every war since the invention of the written language has brought its technological advances, the two World Wars probably brought about more changes for the actual length of time of the conflicts than any other wars. Part of the reason for this, of course, is the capabilities for rapid change made possible by the Industrial Revolution.

The internal combustion engine made airplanes for observation, and later for bombing, a reality, as well as tanks and motorized transport. Crude, man-powered submarines had been used as early as the Revolutionary War, but when war raced across Europe in the summer of 1914, powered submarines were already in service. Although mule transport and horse cavalry lasted on into World War II, mechanization had definitely sounded their death knell.



Stock M1 Carbine as manufactured by Winchester, Inland, Rock Ola, etc.

Almost from its inception, the pistol had been considered a last ditch weapon for cavalry, the primary weapons being the carbine and saber. This practice was still prevalent during the Indian Wars in this country and in the Middle East during World War I. But as horse cavalry vanished into the dim mists of the past, so did the saber. Mechanized cavalry were armed with pistols and, in some cases, submachine guns. While some SMGs

## M1 CARBINE

had found their way into the trenches near the end of the "War To End All Wars", they weren't to become prevalent in warfare until the Spanish Civil War, when their effectiveness in close quarters fighting was firmly established.

Interestingly enough, the United States began looking for a weapon to replace the SMG even before it was used in any quantity by U.S. troops.



**M2 Carbine with folding stock.**

As early as 1938, the U.S. Army began thinking about a light rifle or carbine as a replacement for both the Colt N1911A1 and the Thompson SMG. While the recently adopted M1 Garand rifle was far and away the finest battle rifle in the world at that time, it was too heavy and bulky to be used by support troops who would normally not see combat but who were armed "just in case". Previous practice had been to arm such personnel with the Colt .45, a superior weapon for close in work but definitely not a good choice for the average shooter at medium to long ranges. In the late 1930's, the U.S. armed forces had only a limited number of Thompsons in their inventories, so replacing them would hardly prove an awesome burden. As for the Colt .45, well — it had been in service for nearly thirty years, so was undoubtedly obsolete, as military thinking at that time was beginning to view the military pistol in any form as a relic of the past.

The initial concept of the new light rifle or carbine was for it to weigh five pounds or less, complete with sling, and have an effective range of 300 yards. It should be semi-auto with capability for full automatic fire, have little noticeable recoil and be chambered for a cartridge similar to Winchester's .32 centerfire which they had developed for their Model 1905 autoloading rifle.

In the fall of 1940 the Ordnance Department approached Winchester with their specifications for the new cartridge. Following development work, an order for 150,000 rounds was placed in

June of the following year. A second order for 300,000 rounds followed in August.

Winchester was also invited to submit a prototype weapon for testing, but they were deeply involved in Garand production and declined. When trials began on June 16, John Garand himself had submitted two designs. Others submitting prototypes included Auto Ordnance (manufacturer of the Thompson), Harrington & Richardson, Hyde, Savage, Springfield Armory and Woodhull. Two weeks later, Winchester was again invited to submit a test sample, and agreed. A mere two weeks later to the day, a very quickly hand assembled sample was submitted to Ordnance. While not a true indication of what the production gun would be like, this crudely assembled sample worked so well that Ordnance felt it offered far more promise than any of the other guns previously tested. The Winchester team went back to work at the drawing board and assembly bench and, after 34 days of working literally day and night, had a finished carbine ready for the September tests at Aberdeen Proving Ground. At the end of the testing period, the board unanimously recommended adoption of the Winchester design. Less than two weeks before the attack on Pearl Harbor, an order for 350,000 M1 Carbines was placed with Winchester.

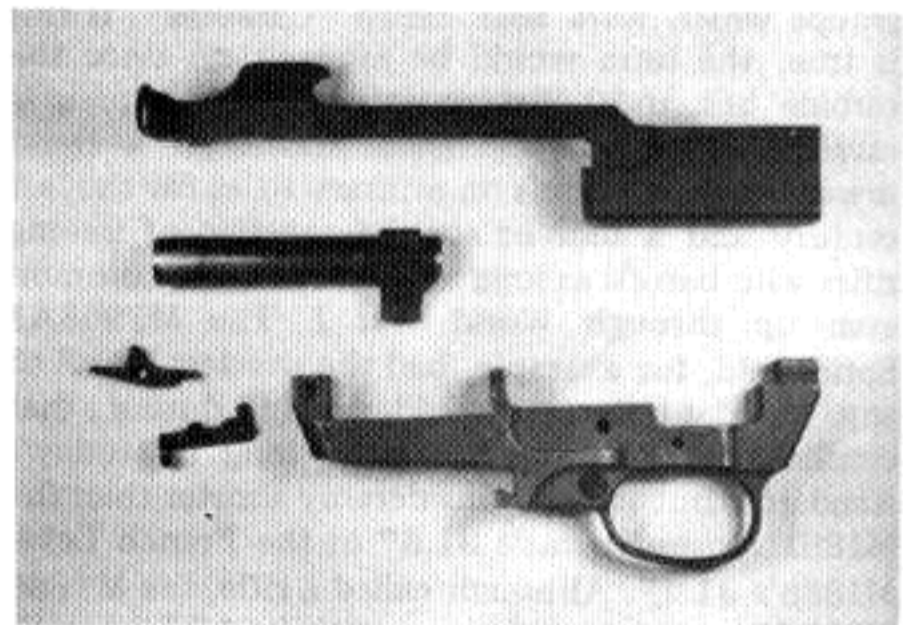

The slide, bolt, sear, magazine catch and trigger housing shown above are necessary for converting the M1 to M2 configuration, but are not considered part of the conversion kit. Not shown, and also necessary for the conversion, is the M2 stock.

Tooling up for large scale production is a different story than creating a prototype, however, and the first carbines didn't come off the Winchester production line until almost three weeks

## M1 CARBINE

after the U.S. Marines had landed on Guadalcanal in August 1942. That particular lot consisted of just 10 carbines.

In order to facilitate speedy delivery of the much-needed carbines as American troops were shipped off to North Africa and the Pacific, production contracts were also awarded to the Inland Manufacturing Division of General Motors, Underwood Elliott Fisher, National Postal Meter, Rock-Ola Manufacturing Corp., Quality Hardware, Standard Products, Saginaw and IBM. Even though Winchester was the only carbine producer that was normally a firearm manufacturer, by the end of 1943 M1s were rolling off the production line at the rate of 500,000 per month.

As the tides of war began to turn in favor of the Allies, it became apparent that a select fire carbine as called for in the original specifications was highly desirable, especially in the jungle where the distances at which confrontations occurred could often be measured in feet rather than yards and where the enemy might be visible for only a few seconds, if at all. Some non-military minds in Washington had trouble distinguishing the concept

of burst fire from that of sustained fire associated with belt-feds. However, requests for a select fire carbine kept coming in from the field commanders who had to stand and watch their men die due to the lack of adequate firepower.

It is highly unusual for a selective fire weapon to be developed from a semi-auto only design, but in the case of the M2 Carbine that is exactly what happened. The end result was actually two different types of M2 Carbines — the “pure” version which was manufactured as a selective fire weapon from the ground up, and the “hybrid” which had gone into service as a standard semi-auto M1, then been converted to M2 configuration by installing a T17 kit. This kit was designed so that existing M1s could be converted to select fire without being sent back to an arsenal for “major surgery”.

M2 Carbines went into production at the Winchester and Inland plants in May 1945, the same month that Germany surrendered. With the surrender of Japan the following September, the world supposedly returned to a state of peace, and production of the M1 and M2 Carbines ended.

### TOTAL PRODUCTION, ALL MODELS

Winchester		Underwood-Elliott-Fisher	
		M1	546,616
Experimental & Prototype	9		Rock-Ola Company
M1	818,059	M1	228,500
M2	17,500		Quality Hardware & Machine Corp.
M3	1,108	M1	359,662
Other	4		National Postal Meter
		M1	412,778
TOTAL	836,680		Commercial Controls Corp.
		M1	239
			Irwin-Pederson Arms Company
Inland Manufacturing Division of General Motors Corporation		M1	146,723
M1	2,285,000		Standard Products Company
M1A1	140,591	M1	346,225
M2	199,500		Saginaw Steering Gear Division of General Motors Corporation
M3	811	M1	370,490
M1A2	5		International Business Machines Corp.
Other	900	M1	346,500
			TOTAL 2,757,733
TOTAL	2,626,807		

# M1 CARBINE

## SERIAL NUMBERS

Inland .....	1 to 5
Winchester .....	6 to 10
Inland .....	11 to 999,999
Winchester .....	1,000,000 to 1,249,999
Underwood .....	1,250,000 to 1,449,999
National Postal Meter .....	1,450,000 to 1,549,999
Quality Hardware & Machine .....	1,550,000 to 1,562,519
Quality Hardware & Machine .....	1,562,520 to 1,662,519
Rock-Ola .....	1,662,520 to 1,762,519
IRWIN PEDERSEN (Saginaw, G.R.) .....	1,762,529 to 1,875,039
Quality Hardware & Machine .....	1,875,040 to 1,907,519
Quality Hardware & Machine .....	1,907,520 to 1,937,519
National Postal Meter .....	1,937,520 to 1,982,519
Standard Products .....	1,982,520 to 2,352,519
Underwood .....	2,352,520 to 2,912,519
Inland .....	2,912,520 to 3,212,519
Irwin Pedersen (Saginaw, G.R.) .....	3,212,520 to 3,250,019
Saginaw S.G. ....	3,250,020 to 3,651,519
I.B.M. ....	3,651,520 to 4,009,999
Underwood .....	4,010,000 to 4,074,999
National Postal Meter .....	4,075,000 to 4,079,999
National Postal Meter .....	4,080,000 to 4,432,099
Quality Hardware & Machine .....	4,432,100 to 4,532,099
Rock-Ola .....	4,532,100 to 4,632,099
Quality Hardware & Machine .....	4,632,100 to 4,879,525
Inland .....	4,879,526 to 5,549,821
Winchester .....	5,549,822 to 5,834,618
Saginaw S.G. ....	5,834,619 to 6,071,188
Rock-Ola .....	6,071,189 to 6,099,688
Underwood .....	6,099,689 to 6,199,688
Rock-Ola .....	6,199,689 to 6,219,688
Inland .....	6,219,689 to 6,449,867
Winchester .....	6,449,868 to 6,629,883
Inland .....	6,629,884 to 7,234,883
Winchester .....	7,234,884 to 7,369,660
Inland .....	7,369,661 to 8,069,660
Commercial Controls Corp. ....	0001 to 0239

\* The reader may note that the assigned serial numbers above add up to approximately 2 million more carbines than the 6 million total production discussed in the text. This is not a typographical error, but is the result of spare numbers being assigned within blocks of numbers, some receivers being scrapped after being stamped and their numbers being re-used at a later date, etc. Additionally, major design changes or improvements were often designated by starting with a new block of numbers and purposely leaving a gap between the numbers of the first gun of the new model and the last one of the old.

## M1 CARBINE

A total of over 6,000,000 of both models was produced before VJ Day.

Less than five years after the Japanese surrender in Tokyo Bay, war clouds again loomed over Japan when North Korean troops moved south in June of 1950. One need only study a map of the Far East to realize the trepidation that must have filled the minds of American occupation troops in Japan at the outbreak of the Korean War. Within weeks, mothballed fighter aircraft, landing craft, Garands and M1 and M2 Carbines were being refurbished to go to war. For three years the M1 Carbine was to serve American troops in the frozen wastes of Korea, and names like Pork Chop Hill, Inchon and the Yalu River had become as familiar to the American people as Omaha Beach, El Alamein and Iwo Jima. With the signing of an uneasy truce in July 1953, the M1s and M2s were once more put back into storage.

Only a year later, an event took place that was to signal the M1's return to the front lines for yet another war. A French Indochinese fort by the name of Dien Bien Phu fell to Communist forces in far off Southeast Asia. However, it doesn't seem so far away today when you think of the present name for the country in which Dien Bien Phu is located — Vietnam.

With the end of the 300 year French rule in Indochina, the peninsula was divided into three countries, the largest being Vietnam. One might have thought the French withdrawal would bring peace to Southeast Asia, but such was not the case. Fighting continued between Communist regulars and guerrillas and the forces of the democratic governments of the countries that had been French Indochina. The situation had deteriorated so badly by the early 1960's that American "advisors" were sent to help the South Vietnamese. What followed was history, with American troops eventually becoming involved in the longest war in which America ever fought. By the time the Vietnam War officially ended in the early 1970's, over 50,000 American servicemen had paid the ultimate price for freedom.

Although some M1 Carbines saw service with American troops in Vietnam, by far the greatest users of the M1 were the Vietnamese themselves. Due to their smaller physical stature, they liked the small, light carbine with the negligible recoil. The M1 Garand had, of course, been replaced by the M14 as the standard service rifle. Although the 7.62mm NATO cartridge of the M14 produced less recoil than the Garand's .30-06, it was still a bit much for the Vietnamese. They

made do with M1 Carbines until the Armalite AR-15 became available in quantity. It was largely upon their recommendation that Gen. William Westmoreland requested AR-15s for the American troops which were dissatisfied with the M14's performance in the tropics. It should be pointed out, however, that the AR-15 which had endeared itself to the Vietnamese was a select fire weapon that was the forerunner of the M16, and not the semi-auto only civilian AR-15 we know today.

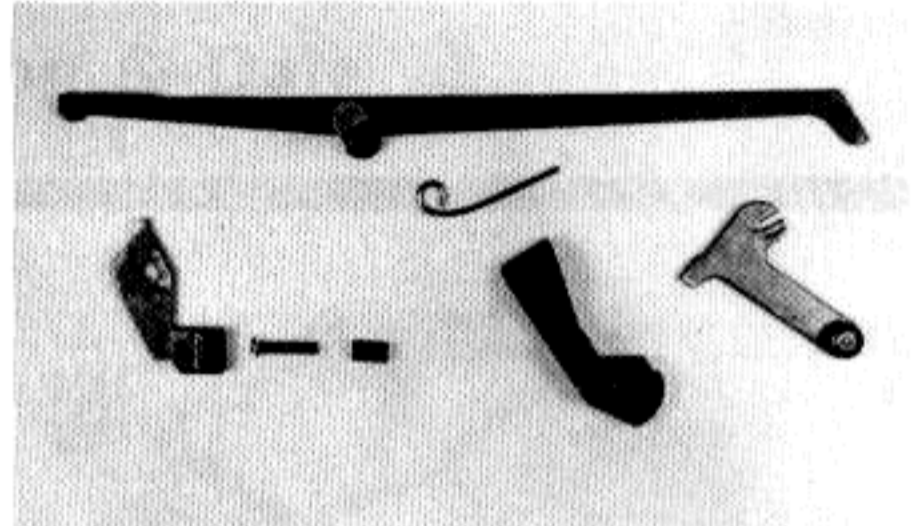

Although once readily available at gun shows, the M2 parts shown above are available as a group now only through Class III dealers since the complete kit is classified as a machine gun, even in the absence of the carbine itself.

Although the M1 and M2 Carbines are no longer standard issue with any American military unit, a number of them are still in government storage for possible future use. As of Spring 1984, 65,984 M1 and 7,298 M2 Carbines were being held for special contingency and foreign military sales requirements. M1 Carbines are likely to be encountered just about anywhere in the world, either in the hands of guerrillas or small local militia units fighting against them. While the M1 failed to replace either the Colt M1911 A1 or the SMG, both of which are still on active duty with U.S. forces, it served its country and her allies well in war and is now a favorite "pickup" gun of ranchers and farmers who want a small, lightweight arm with minimal recoil that is still more powerful than a .22 rimfire. Just how many surplus M1 Carbines have found their way into civilian hands is anyone's guess, but the fact that Ruger chambered its popular Blackhawk single action revolver for the .30 Carbine cartridge attests to the round's popularity.

Numerous commercial models of the M1 have been produced by various manufacturers since World War II and Iver Johnson currently offers a

## M1 CARBINE

select fire version for police and foreign markets as well as the "standard" version for the U.S. civilian market. Whether as a surplus weapon picked up at

a gun show or brand new out of the box from the local gun shop, the M1 Carbine should be with us for a long time to come.



## II. Description & Data

### DESCRIPTION

The carbines are gas-operated, self-loading, air-cooled shoulder weapons, fed by 15-round or 30-round cartridge magazines. The carbines M1 and M1A1 deliver semi-automatic fire, and the carbines M2 and M3 deliver either semi-automatic or full automatic fire controlled by the operator through the use of a selector.

### DIFFERENCES BETWEEN MODELS

*a. Tactical Inspection.* For information on differences between models which affect troop use, refer to page 44.

*b. Cal. .30 Carbines M1 and M1A1* (Figs. 1 and 2). The only difference between the carbines M1 and M1A1 is the stock. The M1 has a one-piece wooden stock, whereas the M1A1 has a folding metal stock extension and a wooden hand grip.

*c. Cal. .30 Carbines M2 and M3* (Figs. 3 and 3a). The carbine M2 is the same as the M1 except for differences in design of certain components and the addition of others (*d* below), which permit the M2 to deliver either semi-automatic or full automatic fire. The carbine M3 is the same as the M2 except that the rear sight is not included and the top of the receiver is designed to accommodate special sighting equipment (sniperscope) issued by the Corps of Engineers. Information on the sniperscope may be found in TM 5-9341.

*d. Component Differences Between Full Automatic and Semi-Automatic Carbines* (Fig. 3b).

Note. The hammer, sear, trigger housing, operating slide, and stock of the carbine M2

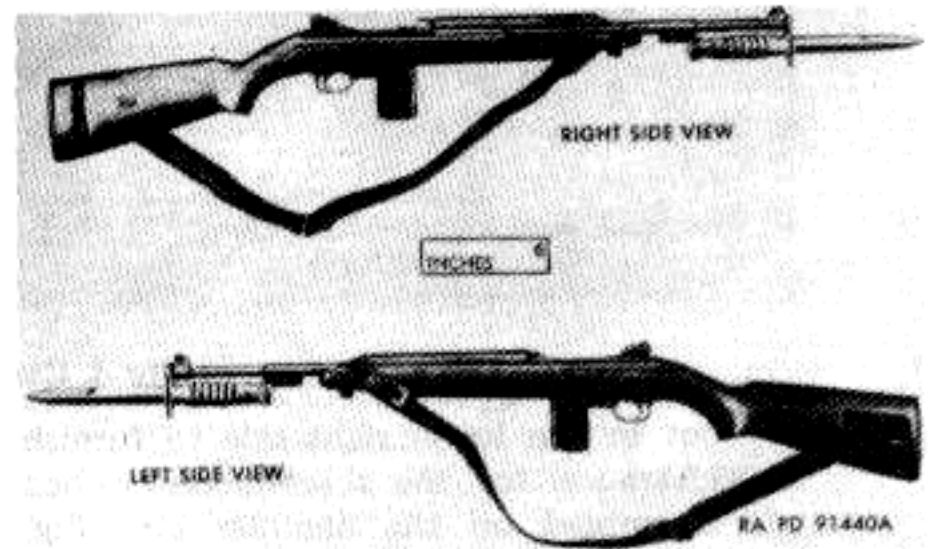

Figure 1. Cal. .30 carbine M1.

(described in (1) through (5) below) can also be used on the carbine M1.

- (1) *Hammer.* The hammer of the carbine M2 is the same as the hammer of the M1 carbine, except that it has a milled

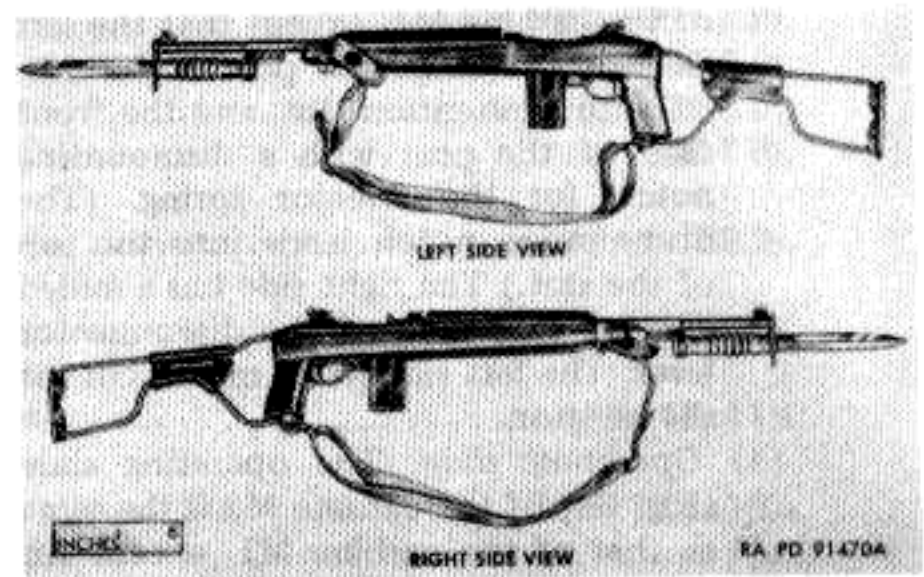

Figure 2. Cal. .30 carbine M1A1.



## M1 CARBINE

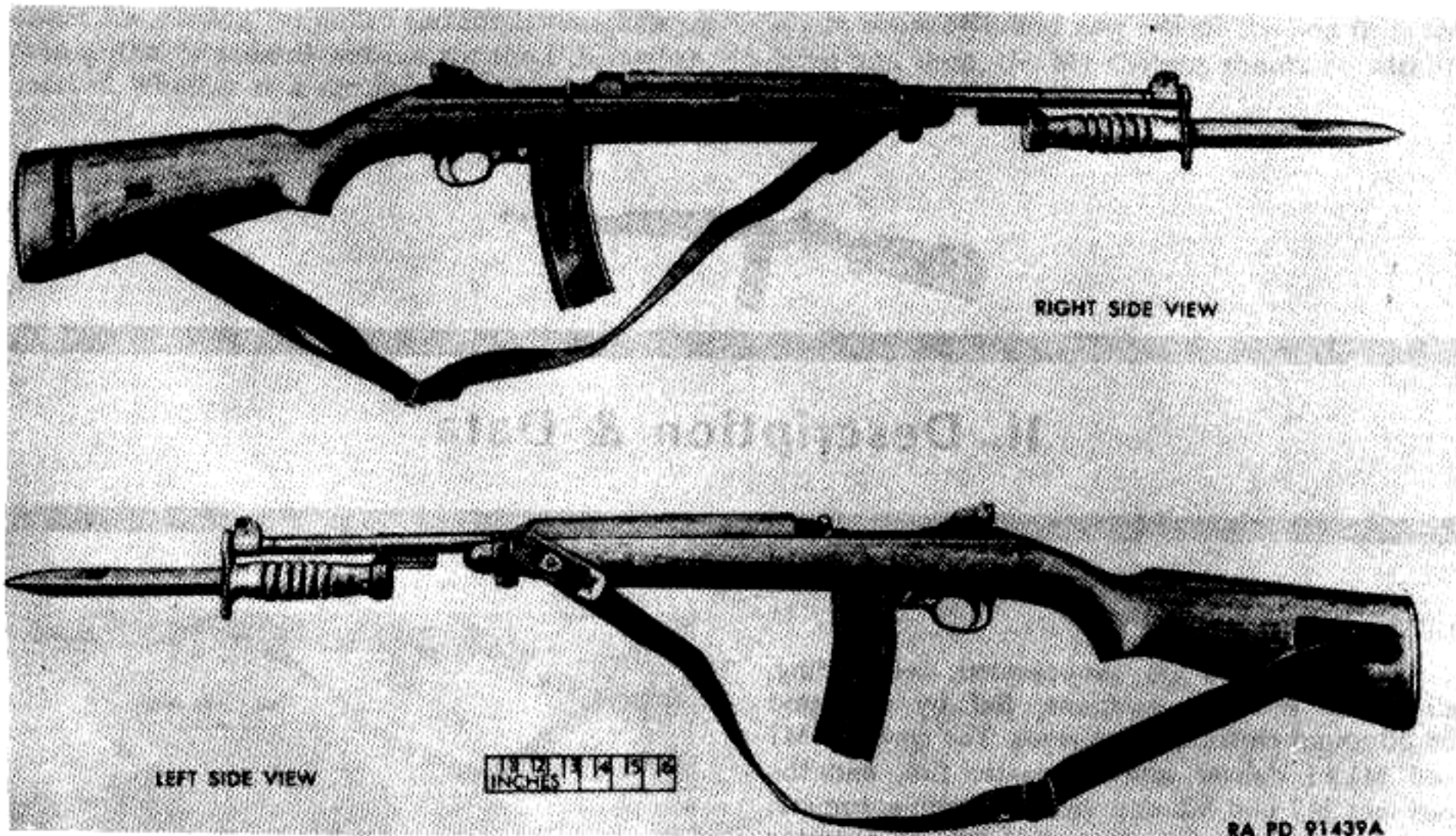

Figure 3. Cal. .30 carbine M2.

cut in the lower right side to furnish clearance for the disconnecter when assembled on the hammer pin (Fig. 49).

- (2) *Sear*. The sear (Fig. 52) of the carbine M2 is the same as the sear of the carbine M1, except for a raised shoulder on the top of the front end, which forms a camming surface for the disconnecter when operated.
- (3) *Trigger housing*. The trigger housing of the carbine M2 is the same as that of the carbine M1, except that the left side of the magazine post is furnished with a retention slot, and the front face of the post with a dismounting notch for the selector spring. (The dismounting notch leads into the top of the slot.) The right side has a milled cut for clearance of the disconnecter lever. The left side has a milled cut for the selector.
- (4) *Operating slide*. The operating slide (Fig. 58) of the carbine M2 is the same as that of the carbine M1, except for a clearance cut extending along the right-hand side of the body, and a

diagonal cut at the point where the shank of the handle joins the body. The latter cut forms a cam for camming down the forward end of the disconnecter lever.

- (5) *Stock* (Fig. 99). A clearance cut is made in the inner right wall of the M2 carbine to provide clearance for the projecting right side of the disconnecter. A cut is also made in the inner left wall for clearance for the selector. The bridge is cut down to the central section for clearance for the disconnecter lever.
- (6) *Disconnecter group — added parts* (Fig. 56). The disconnecter pivots on the hammer pin when assembled. The rear end has a lateral projection, which bears upon the raised shoulder of the sear, when the disconnecter is cam-operated by the disconnecter lever for full automatic fire. The forward end has a projecting lug on the right side, which extends outside the trigger housing and engages and acts as a camming surface for the rear end of the disconnecter lever. A spring and a

# M1 CARBINE

## TABULATED DATA

Weight of carbines M1, M2 and M3 (without sniperscope) with 15-round magazine (unloaded) . . . . .	5.50 lb.
Weight of carbine M1A1, with 15-round magazine (unloaded) . . . . .	6.19 lb.
Weight of carbines M1, M2 and M3 (without sniperscope) with 15-round magazine (loaded) and sling . . . . .	6.10 lb.
Weight of carbine M1A1 with 15-round magazine (loaded) and sling . . . . .	6.79 lb.
Weight of carbines M2 and M3 (without sniper- scope) with 30-round magazine (unloaded) . . . . .	5.53 lb.
Weight of carbines M2 and M3 (without sniper- scope) with 30-round magazine (loaded) . . . . .	6.60 lb.
Magazine capacity (old type) . . . . .	15 rd.
Magazine capacity (new type) . . . . .	30 rd.
Weight of 15-round magazine (unloaded) . . . . .	0.17 lb.
Weight of 15-round magazine (loaded) . . . . .	0.59 lb.
Weight of 30-round magazine (unloaded) . . . . .	0.23 lb.
Weight of 30-round magazine (loaded) . . . . .	1.07 lb.
Over-all length of carbines M1, M2 and M3 . . . . .	35.58 in.
Over-all length of carbine M1A1 (stock extension extended) . . . . .	35.63 in.
Over-all length of carbine M1A1 (stock extension folded) . . . . .	25.51 in.
Over-all length of carbines M1, M2 and M3 with bayonet attached . . . . .	42.26 in.
Over-all length of carbine M1A1 with bayonet attached (stock extended) . . . . .	41.31 in.
Weight of 100 cartridges . . . . .	2.8 lb.
Weight of 1 ball cartridge . . . . .	193 gr.
Weight of bullet (approx.) . . . . .	111 gr.
Muzzle velocity . . . . .	1,900-2,000 f.p.s.
Pressure in chamber per square inch maximum (approx.) . . . . .	40,000 lb.
Maximum range . . . . .	2,000 yd.
Effective range . . . . .	300 yd.
Rate of fire, full automatic (M2 and M3) . . . . .	750-775 r.p.m.
Length of barrel . . . . .	18.00 in.
Sight radius at 100 yards . . . . .	21.5 in.
Trigger pull . . . . .	4½-7 lb.
Shipping weight of nailed wood box containing 10 carbines M1, M2 or M3 (without sniperscope) . . . . .	98 lb.
Shipping weight of nailed wood box containing 10 carbines M1A1 . . . . .	90 lb.
Dimensions (outside) of nailed wood box containing 10 carbines M1, M2 or M3 (without sniperscope) . . . . .	40¾x17x11¾
Dimensions (outside) of nailed wood box containing 10 carbines (M1A1) . . . . .	30½x19½x10¼

*[Continued on following page]*

## M1 CARBINE

Cubical displacement of nailed wood box containing 10 carbines M1, M2 or M3 (without sniperscope) .....	4.7 cu. ft.
Cubical displacement of nailed wood box containing 10 carbines M1A1 .....	3.5 cu. ft.

### NOTE ON AUTOMATIC CONVERSIONS

As originally manufactured, the M1 and M1A1 .30 Carbines were built to deliver semi-automatic fire. The M2 and M3 were later designed to deliver selective fire for greater combat effectiveness, by the addition and modification of certain components. Thus the M1 and M1A1 carbines are readily converted to give selective semi-automatic or full automatic fire by the substitution and addition of the necessary internal parts.

HOWEVER, the National Firearms Act of 1968 levies a tax of \$200 and demands registration upon the making or transfer of any

weapon capable of full automatic fire. Also, the possession of the parts necessary to convert a .30 carbine to selective fire — whether they are actually installed in the gun or not — is considered a violation of the law unless the special tax is paid in advance and the conversion is done with the knowledge and approval of the Alcohol, Tobacco and Firearms Bureau, U.S. Treasury Department (the agency which enthusiastically enforces the U.S. federal gun laws). Police and certain other authorized agencies can claim exemption from the special \$200 tax by applying to the above mentioned agency.

plunger, recessed in the top of the disconnecter and bearing on the receiver, return the disconnecter to the inoperative position, when the camming action of the lever is discontinued.

(7) *Disconnecter lever assembly* — added parts (Fig. 56). The disconnecter lever assembly is not to be disassembled. Replace the lever assembly if any part

is found to be defective. The disconnecter lever assembly is composed of a disconnecter lever pin, disconnecter lever rivet, and disconnecter lever. The pin retains the trigger housing when assembled to the receiver. The disconnecter lever, riveted to a pivot on the pin, is shifted in a vertical plane, by the turning of the pin. The pin is

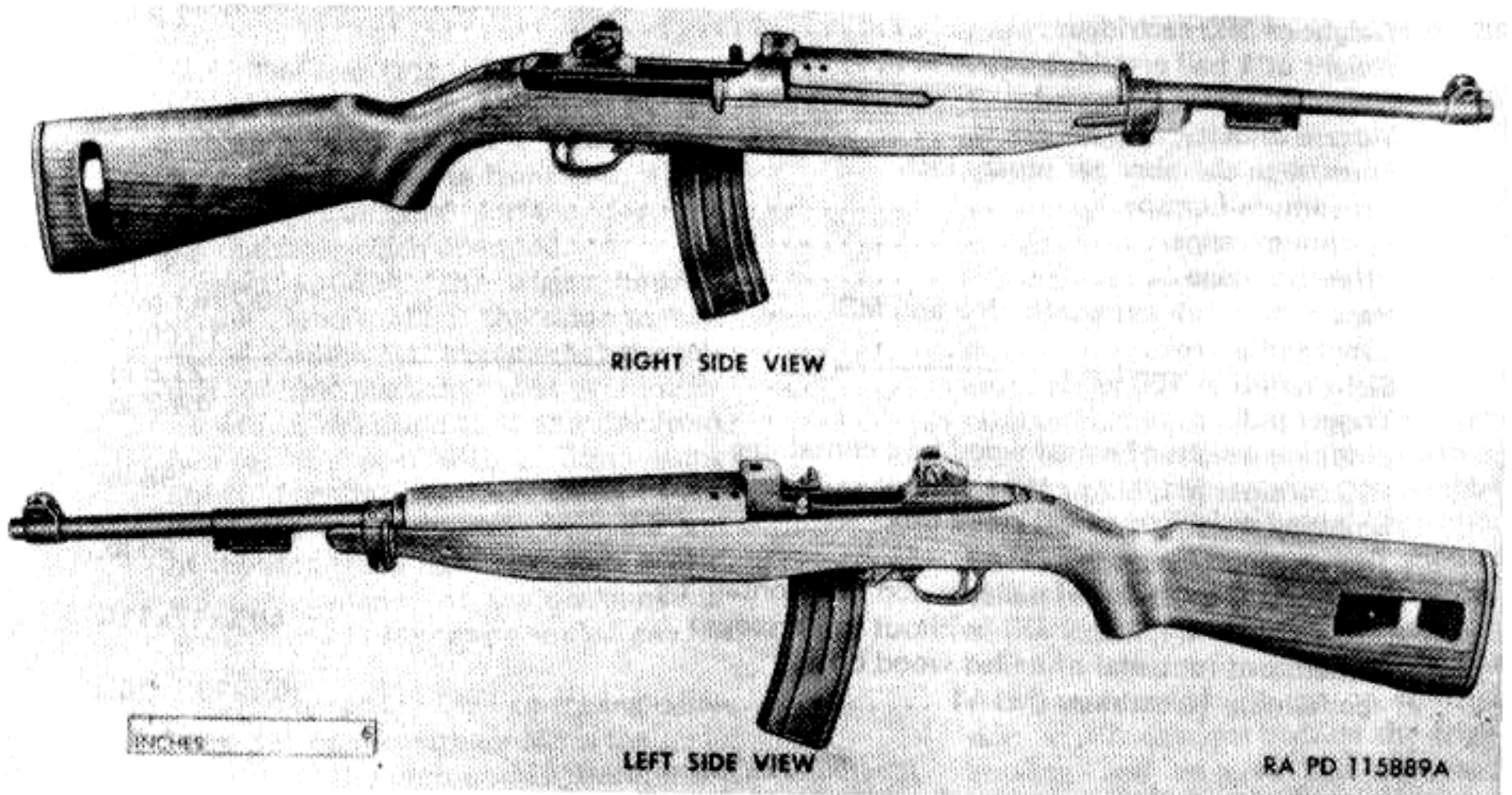

Figure 3a. Cal. .30 carbine M3.

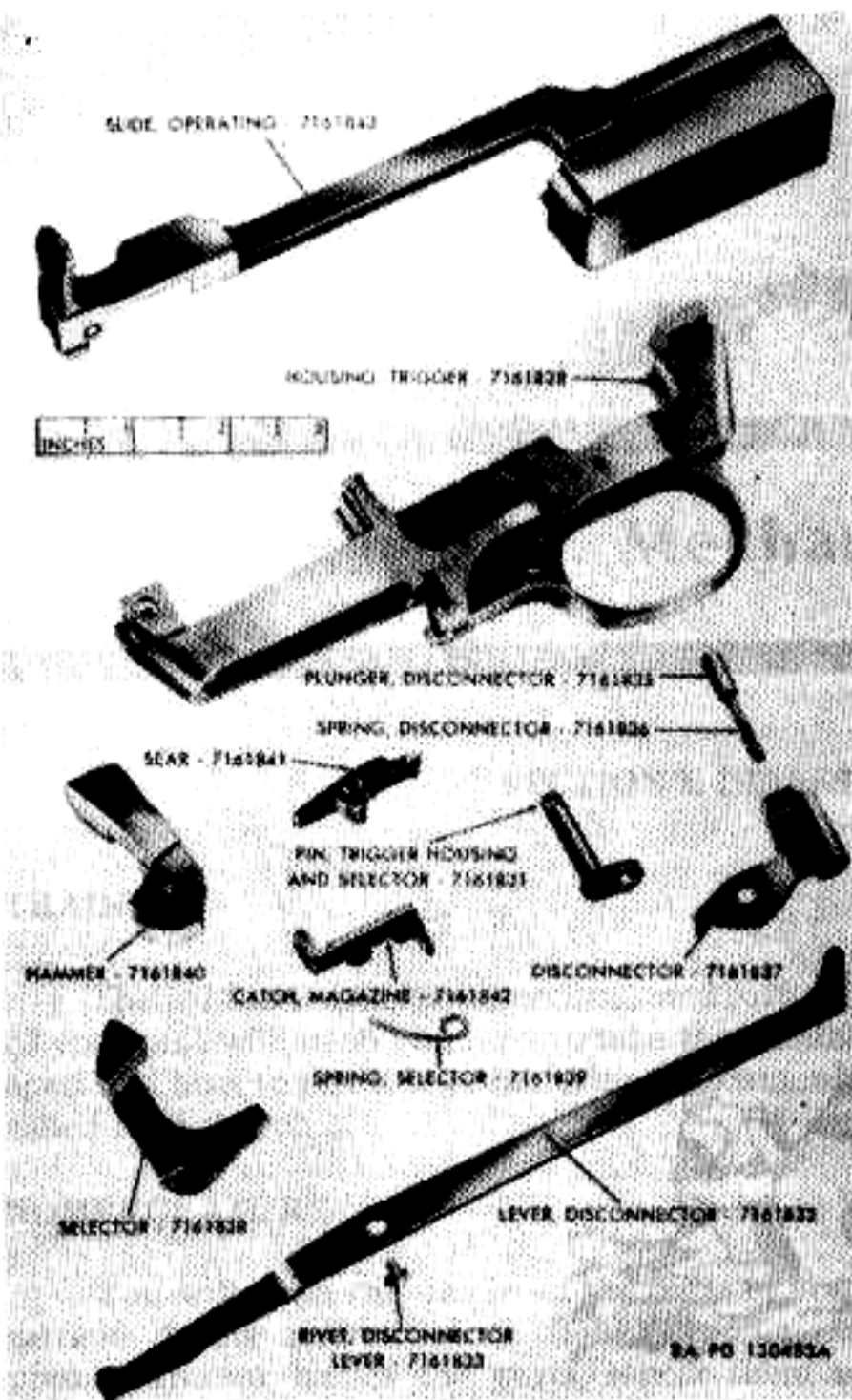

Figure 3b. Operating parts for carbines M2 and M3.

turned by the selector. A rounded projection on the rear end of the disconnecter lever operates the disconnecter. A projecting toe on the front end of the disconnecter lever contacts the camming surface on the operating slide. An offset in the rear section provides for alignment with the disconnecter.

- (8) *Selector group — added parts* (Fig. 56). The selector is mounted to the left end of the crank pin by means of a slot in the lower forward face of the selector mating the straddle slots in the end of the pin. The selector holds the pin in position and acts as a lever for turning, throwing the disconnecter lever into or out of engagement with the operating slide. A curved wire spring holds the selector in position on the pin and in the full automatic or semi-automatic position when operated. The straight front end of the spring seats into a recess in the lower rear end of the selector, and the circular rear end of the spring seats in a vertical slot in the front face of the magazine post on the left side of trigger housing. When assembled, the circular end of the spring is downward (spring is concave downward).



## III. Mechanical Training

### SECTION I. DISASSEMBLY AND ASSEMBLY

#### TRAINING

The officers and noncommissioned officers of your unit will teach you how to take the carbine apart and how to put it together. This is commonly called field stripping.

#### NOMENCLATURE

You will learn the names of the parts of your carbine during instruction in field stripping. As your instructor names the parts, repeat them to yourself and name each part as you remove it and as you replace it. You will find that the parts are generally named for the job they do. For example, the trigger guard actually guards the trigger so that your hands or some other object will not accidentally brush against the trigger and trip it.

#### DISASSEMBLY

*a.* You will be permitted to disassemble only certain parts of your carbine, not because you cannot learn to disassemble all of them, but because constant disassembly causes extra wear. Also, some parts of your carbine require special tools for disassembly.

*b.* Study the following chart. The left-hand column shows those parts that you may disassemble alone. The right-hand column shows those parts that only ordnance personnel may disassemble. The center column indicates those parts that you may remove when supervised.

DISASSEMBLY AUTHORIZED	DISASSEMBLY SUPERVISED BY —		
	INDIVIDUAL SOLDIER	OFFICER, NON-COM, OR ARTIFICER	ORDNANCE PERSONNEL
FIELD STRIPPING	X		
BARREL AND RECEIVER GROUP	X		
Except:			
Gas cylinder piston and piston nut		X	
Bolt			X
Disconnecter lever assembly			X
Rear sight			X
Front sight			X
Magazine		X	
Operating slide group		X	
STOCK GROUP		X	
TRIGGER HOUSING GROUP		X	

#### GUIDES TO FOLLOW

These guides should be followed when disassembling and assembling the carbine.

*a.* As the carbine is disassembled, lay out the parts from left to right on a clean flat surface in the order of disassembly. This procedure will help you as you assemble the carbine.

*b.* Do not attempt to disassemble the carbine against time.

*c.* If it is necessary to apply force, do it carefully so you won't damage any of the parts.

#### FIELD STRIPPING

You must learn field stripping so well that you can do it in the dark. You can field strip your

## M1 CARBINE

carbine by using only a screwdriver, or a dummy cartridge, and the operating slide spring guide. In combat, you may use a live cartridge.

**Caution:** WHEN USING A LIVE CARTRIDGE, BE CAREFUL NOT TO STRIKE THE PRIMER.

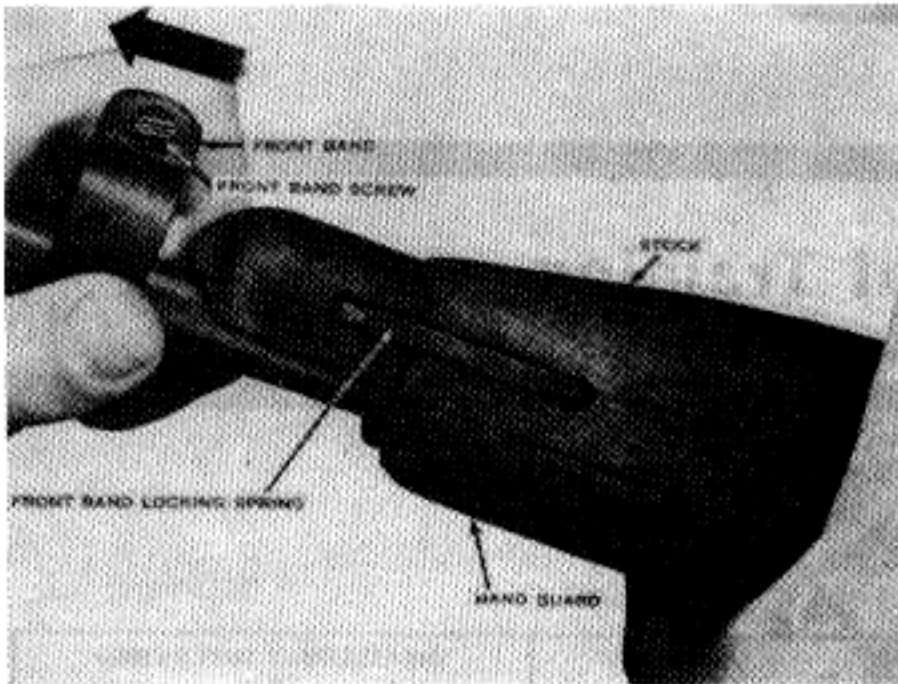

Figure 4. Sliding the front band forward.

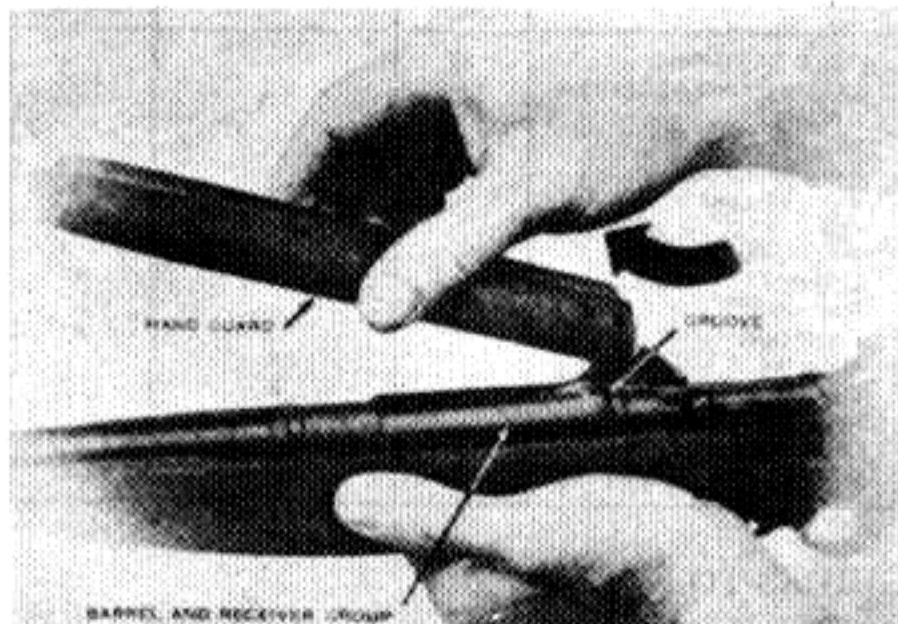

Figure 5. Removing the hand guard.

### PROCEDURE FOR DISASSEMBLY OF THE CARBINE (FIELD STRIPPING)

To field strip the carbine —

a. Grasp the carbine with the left hand near the upper sling swivel. Grasp the magazine with the right hand, depress the magazine catch with the right thumb and remove the magazine. Do not drop the magazine.

b. Unsnap and remove the sling from the upper sling swivel. Allow the sling to hang from the lower sling swivel (the oiler). During field strip-

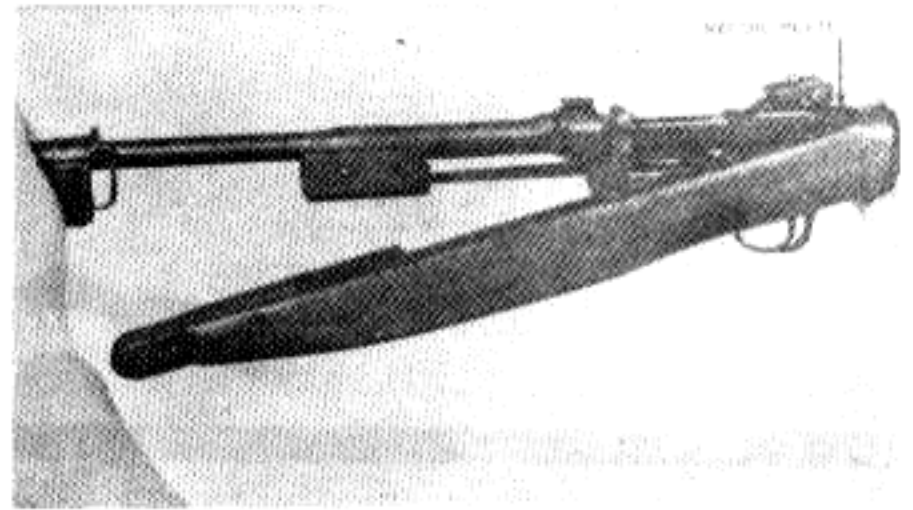

Figure 6. Separating the stock group and the barrel and receiver group.

ping, it is not necessary to remove the sling from the oiler, which serves as the lower sling swivel. However, should this step be required, remove the lower loop from the adjusting buckle and then withdraw the free end of the sling from around the oiler. Remove the oiler from its recess in the stock.

c. To remove the wooden hand guard, you must slide the front band forward toward the muzzle end of the weapon. To do this, grasp the carbine on your left hand with the front band screw head pointing to your right. Using a screwdriver or the rim of a dummy cartridge, loosen the front band screw about one-eighth of an inch. Depress the front band locking spring and slide the front band forward, disengaging it from the stock group and the hand guard (Fig. 4). If the

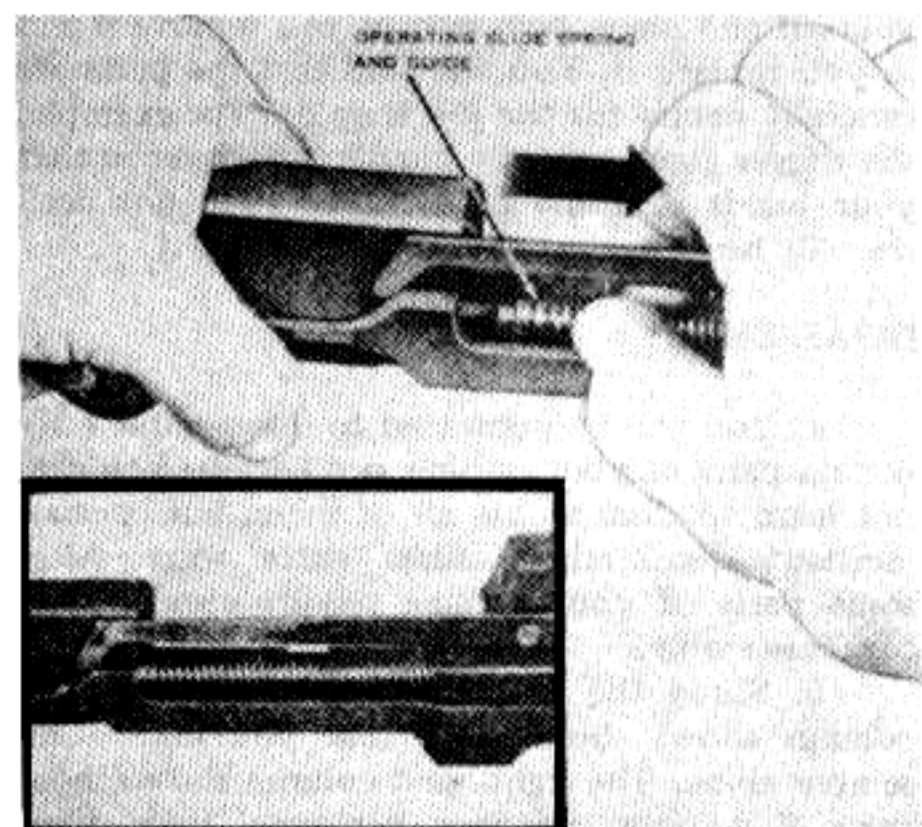

Figure 7. Removing the operating slide spring and guide.

front band sticks, place the bayonet lug over the edge of a table, depress the front band locking spring, pull downward on the carbine, and slide the front band forward.

*d.* Move the hand guard forward until its rear end is disengaged from the groove in the front end of the receiver. Remove the hand guard (Fig. 5).

*e.* Place the carbine on a level surface, muzzle left and sight up. Grasp the small of the stock with the right hand and the barrel with the left hand. Raise the muzzle end of the barrel about 15 degrees until the recoil plate is released from the receiver (Fig. 6). Then separate the barrel and receiver group from the stock group. Place the stock group next to the hand guard.

*f.* Place the barrel and receiver group on a level surface with the muzzle pointing to the left, sights down. With the right thumb and forefinger, pull the operating slide spring and guide to the rear, unseating the operating slide spring guide from its well in the receiver (Fig. 7). Remove the operating slide spring and guide and separate the two parts. The operating slide spring guide will be used as a tool in further disassembly.

*g.* Now rotate the selector to the rear (semi-automatic setting). Insert the point of the operating slide spring guide into the loop of the selector spring (Fig. 8). Push the loop end downward opposite its dismount notch and remove the selector spring. Move the selector forward to the automatic setting. Slide the selector to the rear, disengaging the slot of the selector from the straddle slots on the trigger housing and selector pin.

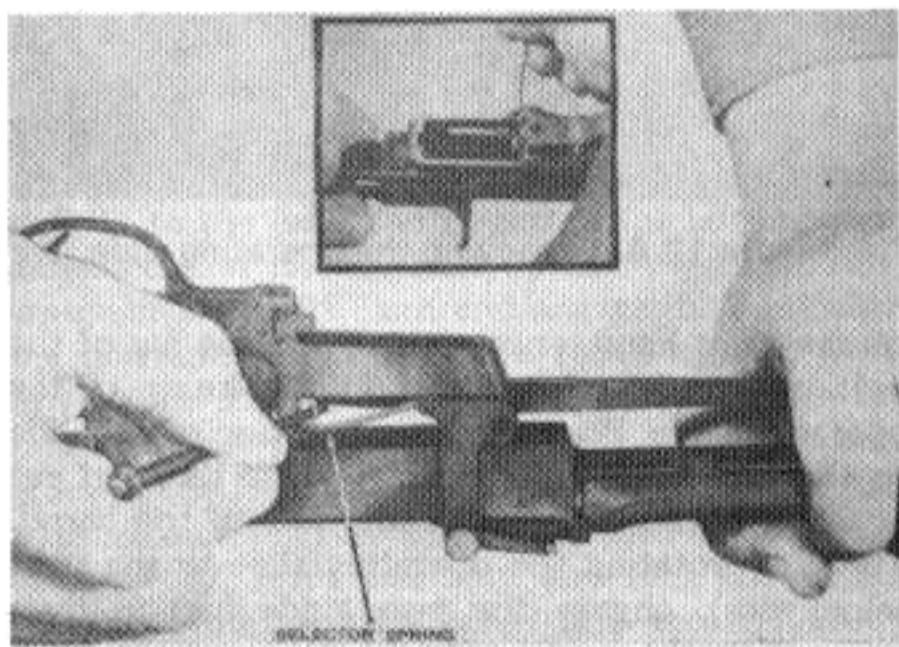

Figure 8. Removing the selector spring.

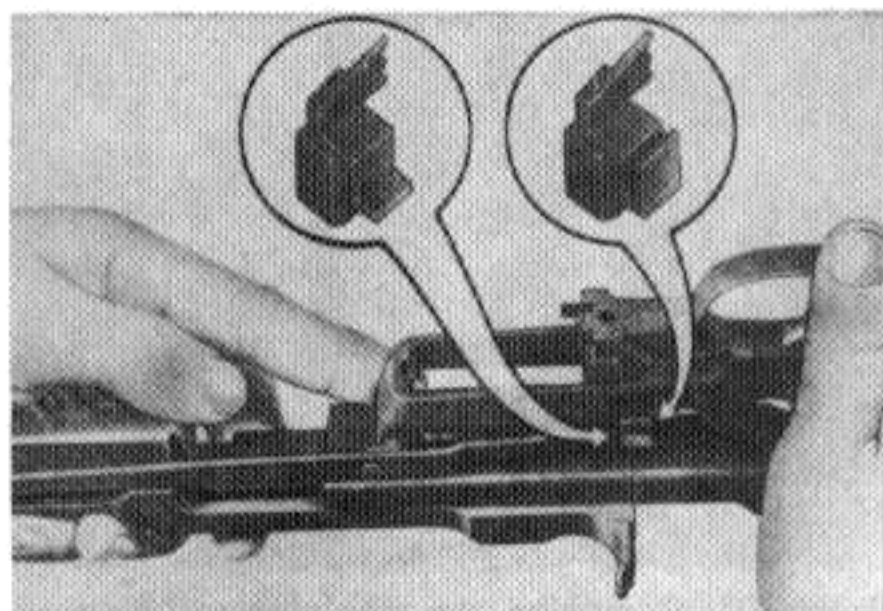

Figure 9. Removing the disconnecter lever assembly.

*h.* To remove the disconnecter lever assembly, push on the trigger housing and selector pin, unseating the disconnecter lever (Fig. 9). Remove the disconnecter lever assembly. If the disconnecter on your weapon has a slotted groove instead of a shoulder, disengage the rear end of the disconnecter lever before attempting to remove the disconnecter lever assembly. To do this, unseat the disconnecter lever assembly and then rotate the crank forward, disengaging the rear end of the disconnecter lever from the slotted groove of the disconnecter (Fig. 10). Now, remove the disconnecter lever assembly.

*i.* Hold the barrel and receiver in the left hand with the muzzle to the left, sights up. Remove the trigger housing group to the rear (Fig. 11). Be careful not to lose the disconnecter spring and plunger assembly.

*j.* Place the barrel and receiver on a level surface with the muzzle to the front, sights up. Lift the rear of the barrel and receiver with the left hand. Grasp the operating slide handle with the right thumb and forefinger and draw the operating slide all the way to the rear. With an upward and outward pressure (Fig. 12-A), move the operating slide forward until the guide lug on the operating slide handle engages in its dismount notch. Pull to the right and up on the operating slide handle, partially disengaging the operating slide from the operating lug on the bolt. Grasp the heavy portion of the operating slide in the palm of the right hand. Move the operating slide forward about one-fourth inch, so that the left guide lug in the heavy portion of the operating slide is opposite its relief cut in the groove on the left under side of the barrel. Remove the operating slide by rotating it counterclockwise (Fig. 12-B).

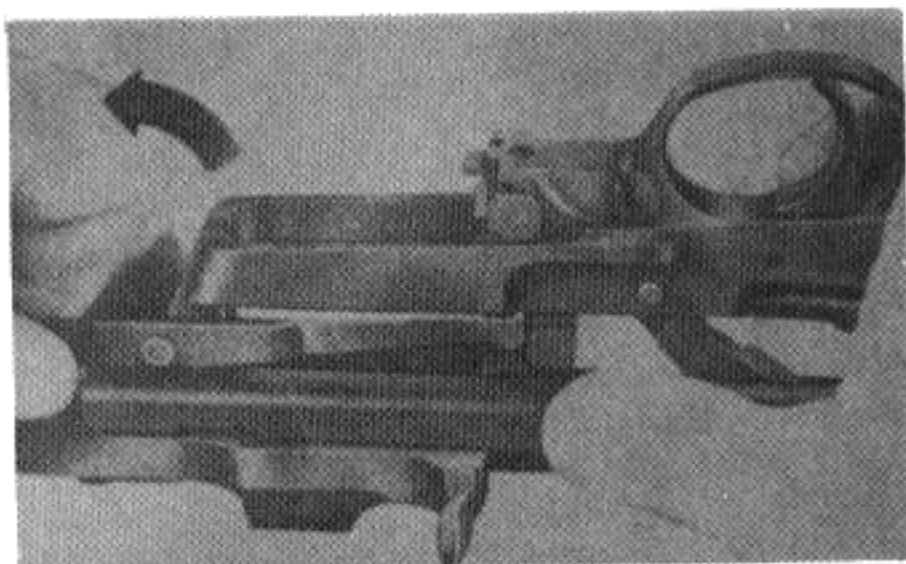

Figure 10. Removing the disconnecter lever assembly.

*k.* Hold the carbine as in *j* above. Grasp the operating lug of the bolt with the right thumb and forefinger and draw the bolt to the rear until its face is just back of the locking recesses. Rotate the bolt to the left until the operating lug is straight up, disengaging the left locking lug on the bolt. Then rotate the bolt to the right until it is level. Raise the bolt to an angle of about 45 degrees and remove it from the receiver (Fig. 13).

*l.* In Figure 14, you see the disassembled parts of the carbine laid out in the correct order.

#### PROCEDURE FOR THE ASSEMBLY OF THE CARBINE AFTER FIELD STRIPPING

To assemble the carbine —

*a.* Place the barrel and receiver on a level surface with the muzzle pointing to the front, sights up. Lift the rear of the barrel and receiver with the left hand. Grasp the operating lug of the bolt with the right thumb and forefinger. Place the base of the bolt over the bridge of the receiver. Hold the bolt at an angle of 45 degrees with

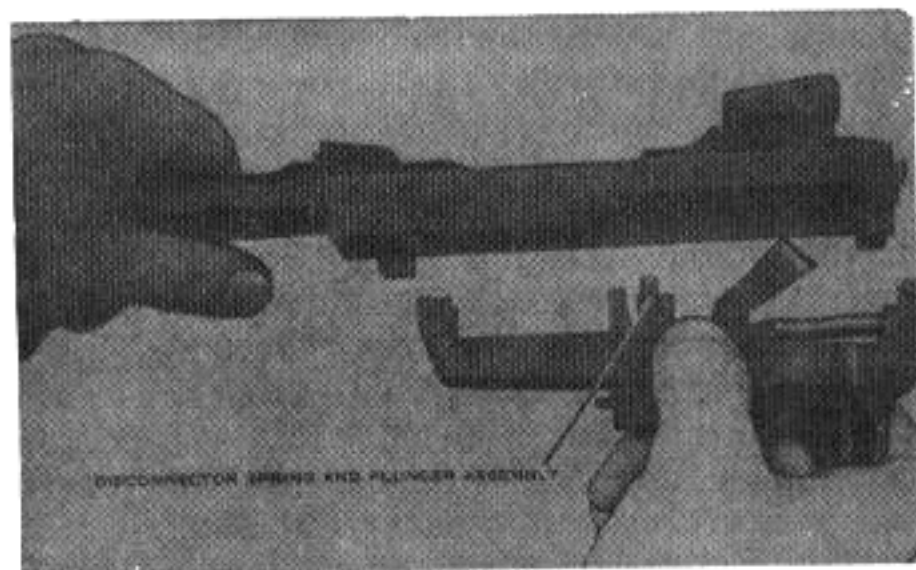

Figure 11. Removing the trigger housing group.

the operating lug pointing to the right. Lower the bolt and engage its left locking lug in the groove in the receiver. Slide the bolt to the rear.

*b.* With the barrel and receiver in the same position as in *a* above, move the bolt forward until its forward end is approximately 1½ inches from the chamber. Hold the bolt in place with the left thumb as shown in Figure 15-A. Holding the heavy portion of the operating slide in the palm

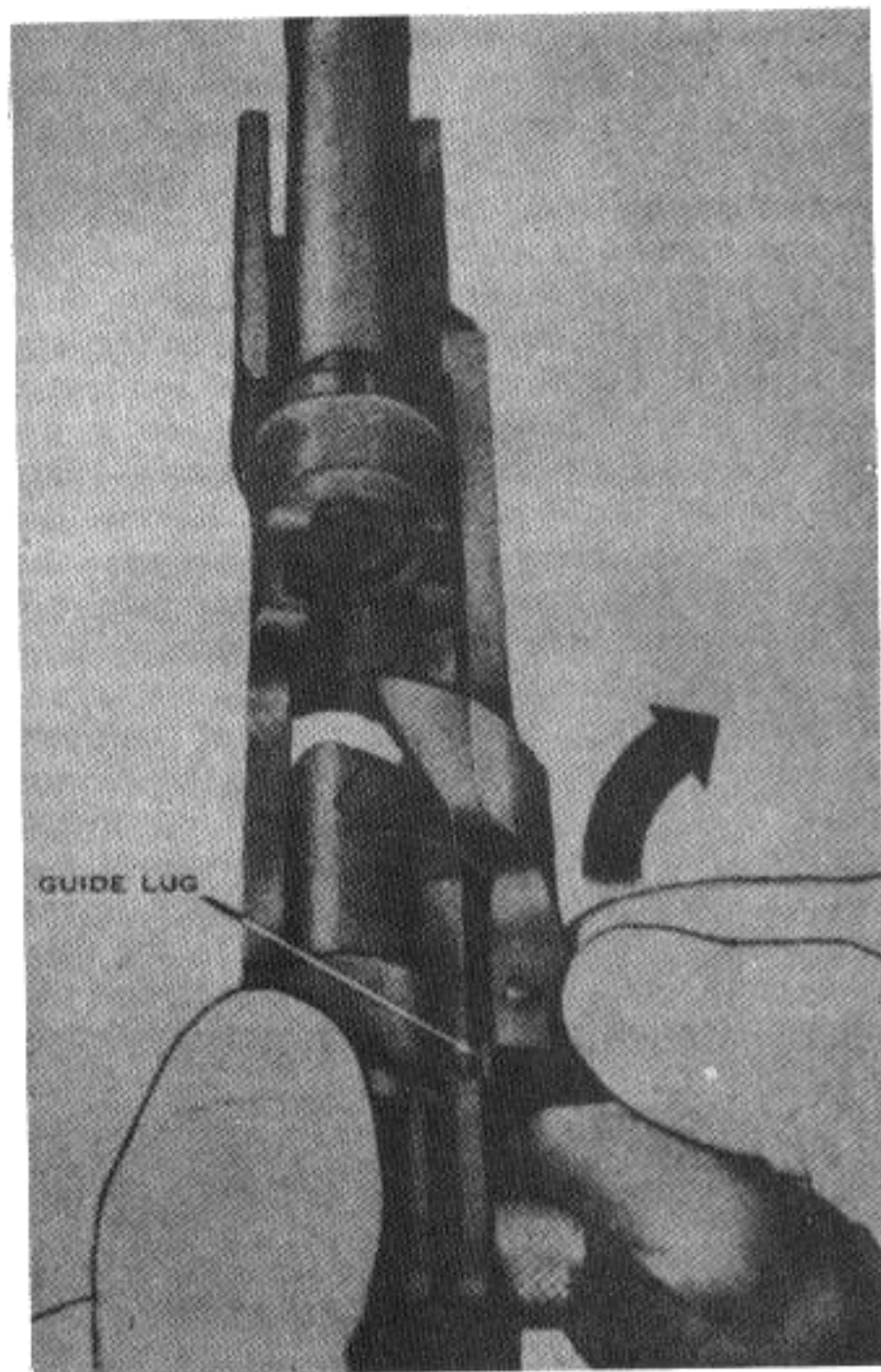

Figure 12-A. Removing the operating slide.

of the right hand, engage the operating lug of the bolt in the camming recess in the hump of the operating slide. Place the heavy portion of the slide so that the left guide lug is opposite its relief cut in the groove on the left under side of the barrel. Then, by rotating the operating slide to the right (clockwise), engage the two guide lugs in their grooves on the barrel (Fig. 15-B). Move the operating slide and bolt to the rear until the operating slide handle guide lug engages in the dismount



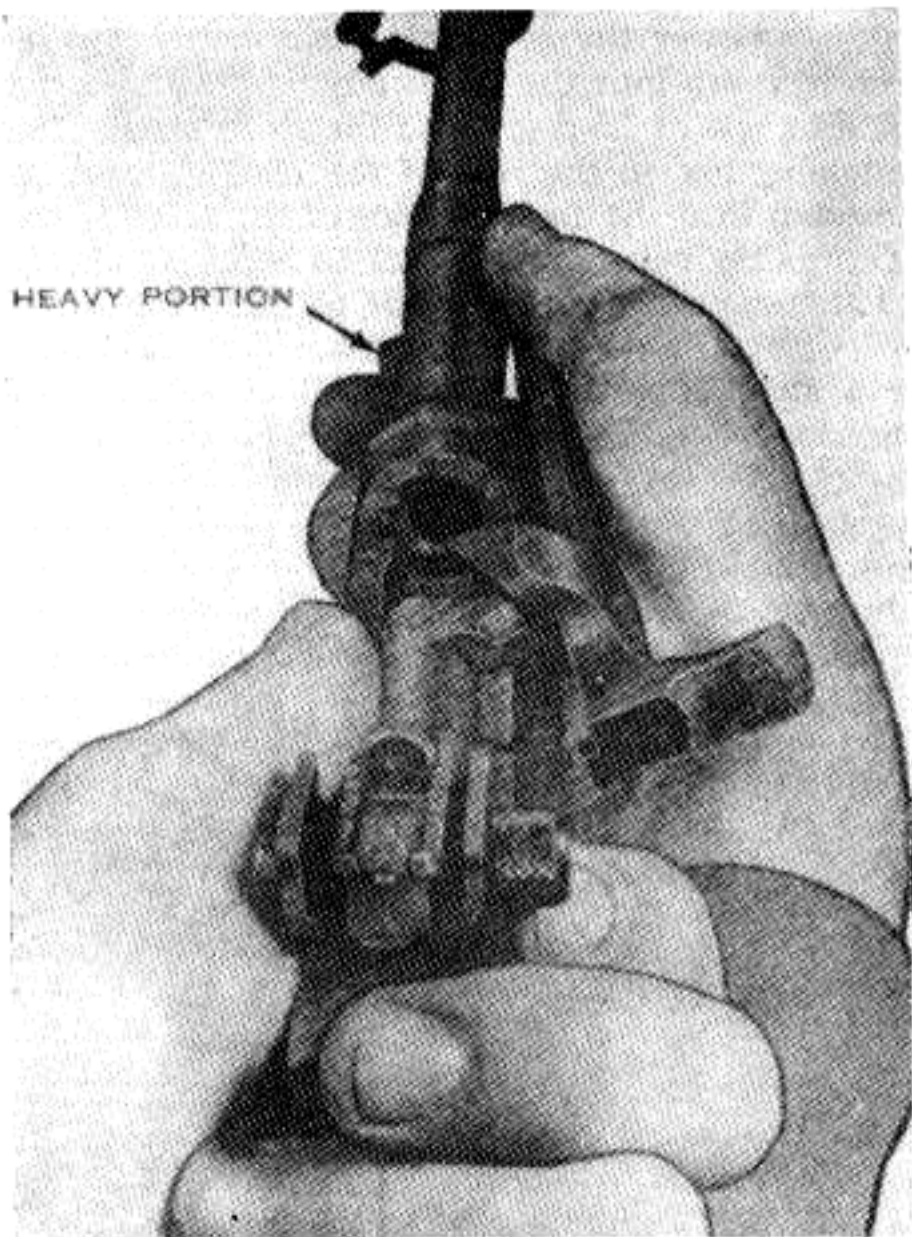

Figure 12-B. Continued.

notch and is seated in its guide groove in the receiver. Move the operating slide forward, closing the bolt.

c. To replace the trigger housing group, first cock the hammer and replace the disconnecter spring and plunger assembly if it was removed. Place the barrel and receiver on the palm of the left hand as shown in Figure 16. The operating slide handle is centered on and vertical to the palm of the left hand with the barrel and receiver canted slightly to the left. The fingers of the left hand are extended and joined. Pick up the trigger housing group in the right hand and engage its T lug with the corresponding slot on the receiver, *from front to rear*. As soon as the T lug is engaged, close the fingers of the left hand about the trigger housing group. You will hear a click. Align the trigger housing and selector pin holes, then pick up the disconnecter lever assembly and lock the trigger housing group to the barrel and receiver group by inserting the trigger housing and selector pin through its holes from right to left. The toe of the disconnecter lever should be pointing toward the

muzzle of the carbine. You will have no trouble seating the disconnecter lever assembly if the disconnecter has a plain shoulder. If the disconnecter has a slotted groove, press inward on the rear of the disconnecter lever and align the rear end of the lever with the slot of the disconnecter. Pull the front end of the disconnecter lever away from the operating slide. Now rotate the disconnecter lever to the rear, engaging its rear end in the disconnecter groove.

d. Place the barrel and receiver on a level surface with the muzzle pointing left, sights down. Engage the slotted portion of the selector with the straddle slot on the end of the trigger housing and selector pin. Rotate the selector to the rear.

e. With the barrel and receiver in the same position as in *d* above, replace the selector spring by inserting its straight end into the recess in the rear of the selector (be sure the loop of the selector

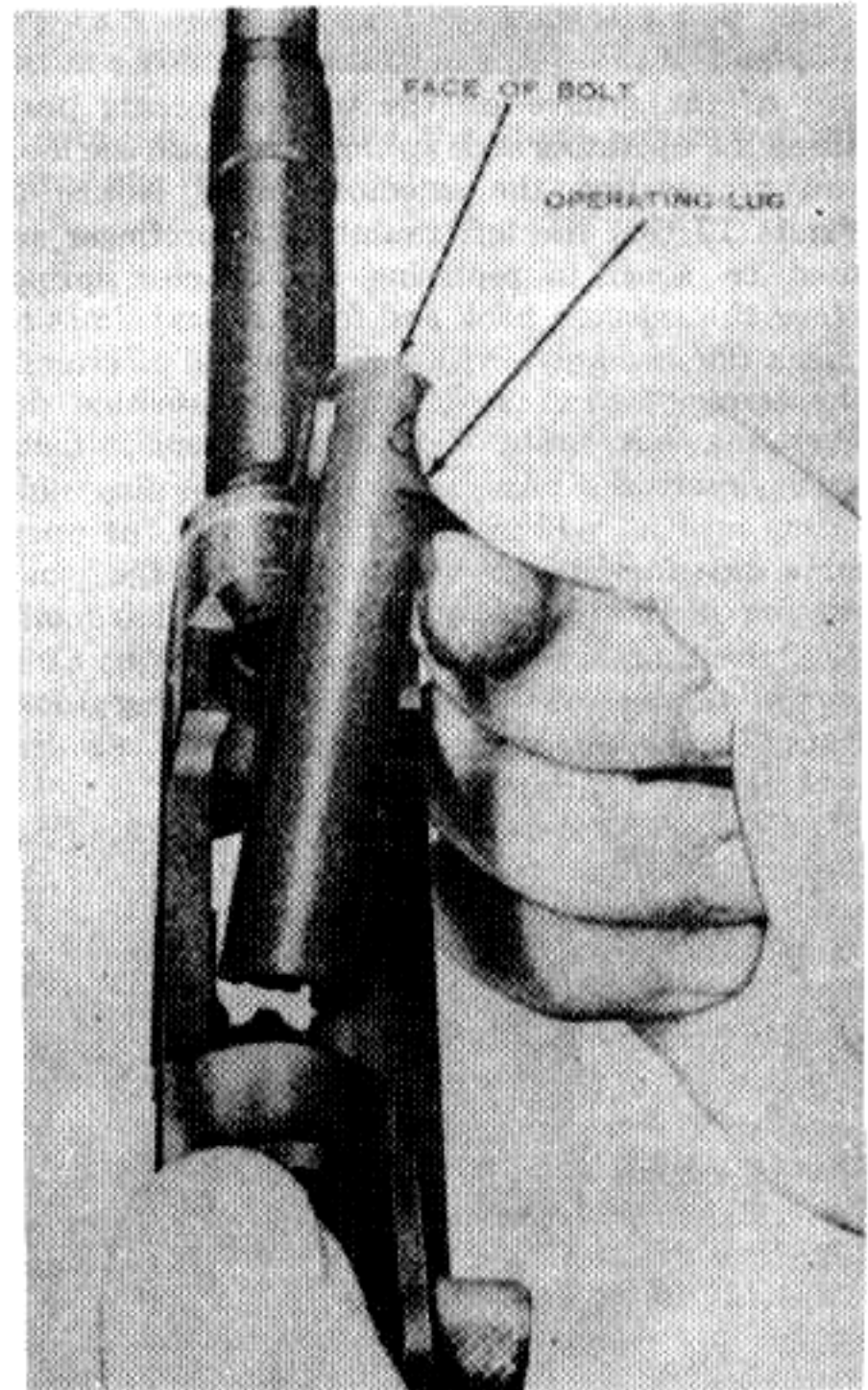

Figure 13. Removing the bolt.

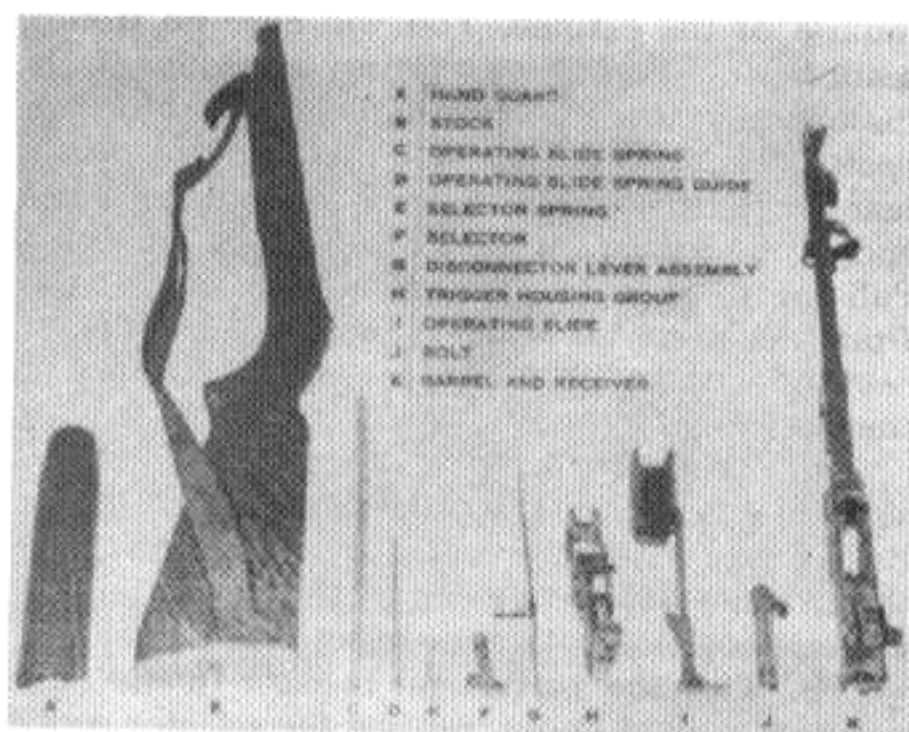

Figure 14. Lay out of parts disassembled during field stripping.

spring points toward the trigger guard). Place the loop end of the spring in its dismount notch at the top of the groove on the trigger housing post. Using the operating slide spring guide, pull the loop end up, seating the selector spring. Notice in Figure 17 that the left thumb and forefinger are used to assist in replacing the selector spring. Move the selector back and forth several times to check the assembly. With the barrel and receiver in the same position as in *d* above, assemble the operating slide spring and guide. To replace these parts, insert the loose end of the operating slide spring into its well in the receiver. With the operating slide forward, grasp the barrel and the heavy portion of the operating slide with the left hand. With the thumb and forefinger of the right hand on the shoulder of the operating slide spring guide, compress the operating slide spring and seat the operating slide spring guide in its recess.

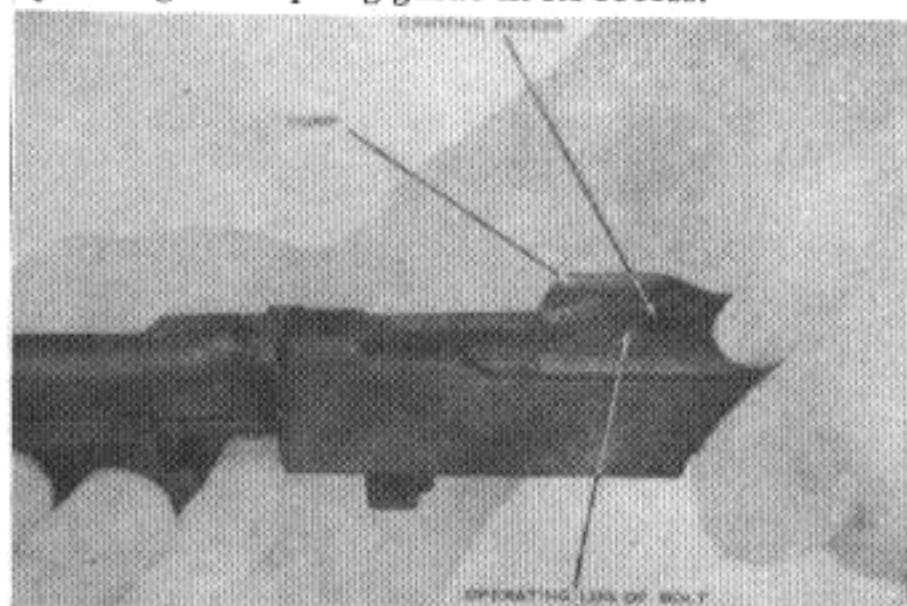

Figure 15-A. Replacing the operating slide.

*f.* Lower the rear end of the barrel and receiver group into the stock group with the barrel at an angle of 15 degrees to the stock group. The retaining lug on the rear of the receiver must be inserted into the forward face of the recoil plate. The barrel will normally fail to seat completely in the stock. *Do not attempt to force the barrel into place.* To seat these parts, grasp the barrel and stock loosely, holding them at an angle of approximately 60 degrees to the horizontal and strike the toe of the butt against the ground (Fig. 18). This permits the recoil plate to spring over the retaining lug and prevents damage to these parts. The barrel will now fit into the groove in the stock without undue pressure being applied.

*g.* With the carbine on a level surface, muzzle left, and sights up, replace the hand guard, engaging its liner in the groove in the receiver. Lock

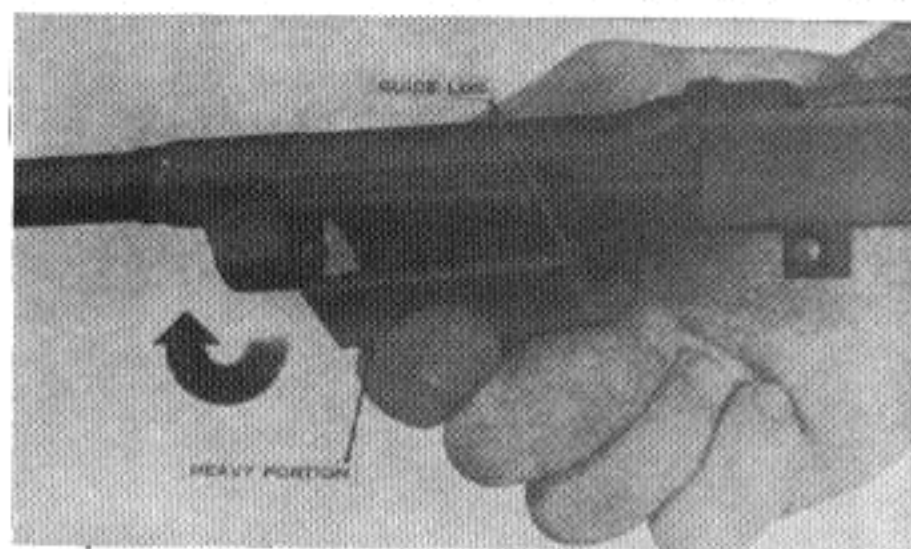

Figure 15-B. Continued.

the stock group, barrel and receiver group, and the hand guard together by sliding the front band down and over the forward ends of the hand guard and stock. Make sure that the front band passes over the front band locking spring. Tighten the front band screw, locking the front band in position.

*h.* Attach the forward end of the sling to the upper sling swivel. If the sling was completely removed, replace the oiler in its recess in the stock. Thread the rear end of the sling through its aperture in the stock, around the oiler, back through the aperture and through the adjusting buckle.

#### DISASSEMBLY OF THE TRIGGER HOUSING GROUP (UNDER SUPERVISION ONLY)

To disassemble the trigger housing group —  
*a.* Squeeze the trigger and ease the hammer forward slowly to the fired position. Grasp the



Figure 16. Replacing the trigger housing group.

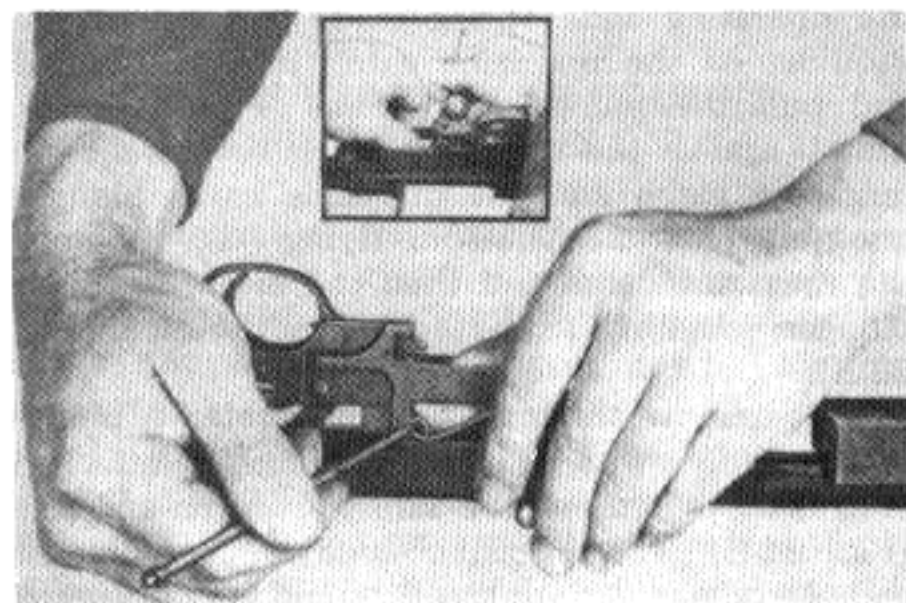

Figure 17. Replacing the selector spring.



Figure 18. Assembling the stock group and the barrel and receiver group.

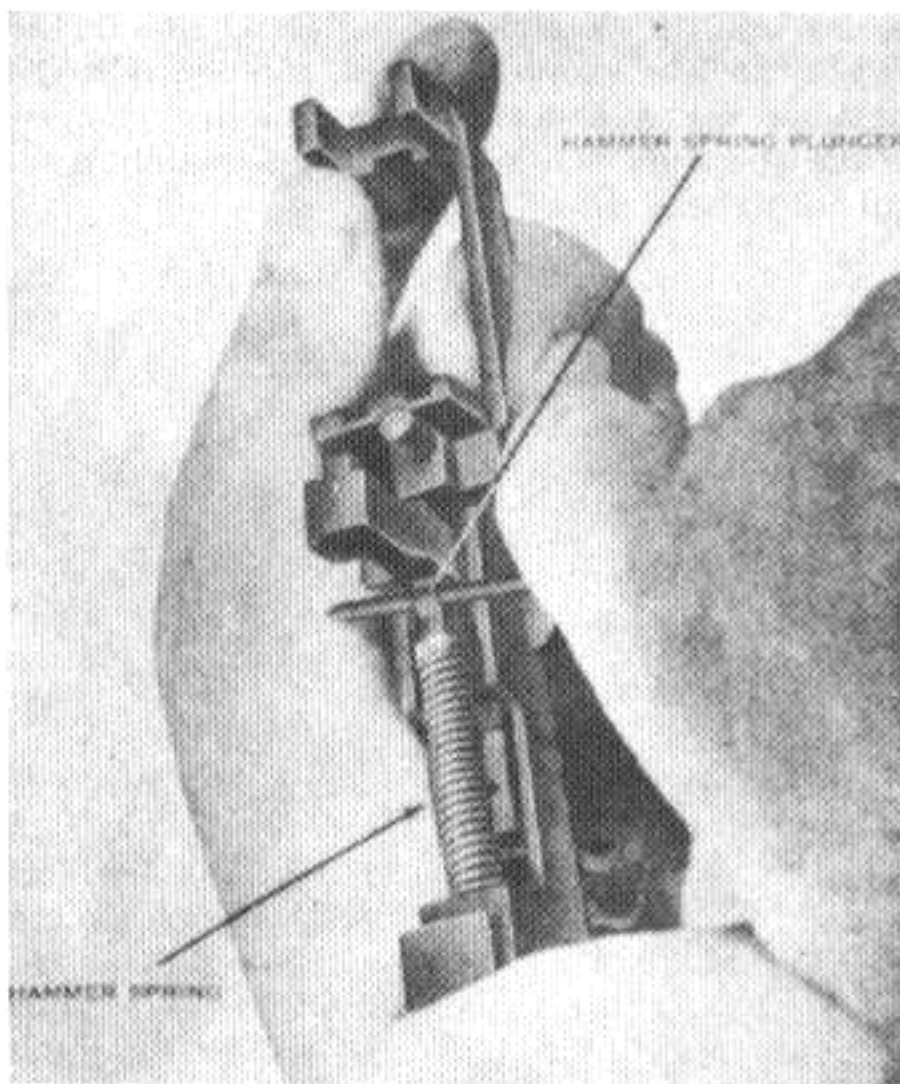

Figure 19. Removing the hammer spring and hammer spring plunger.

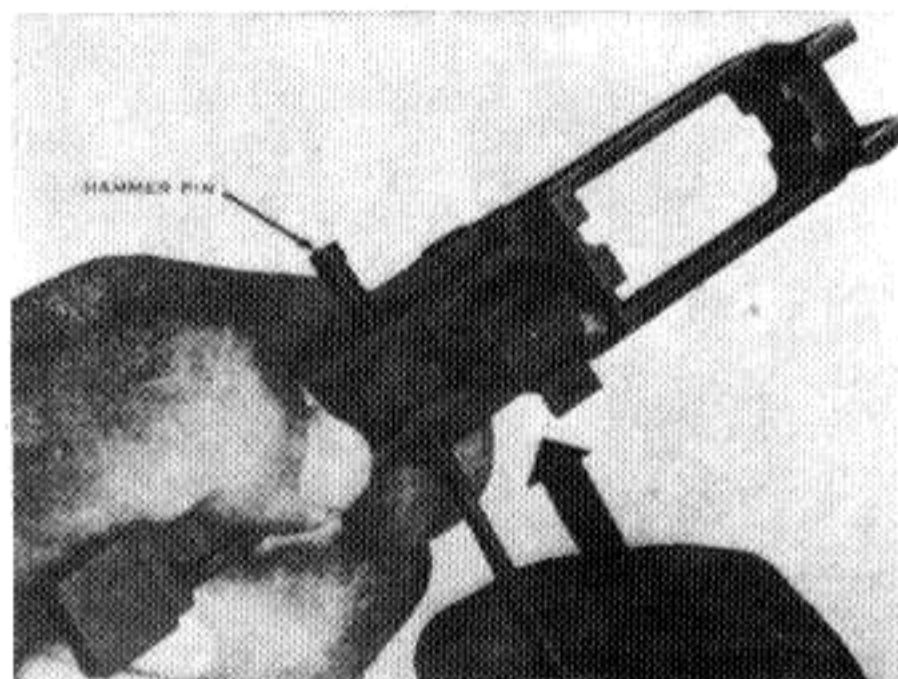

Figure 20. Removing the hammer pin.

trigger housing group in the left hand as shown in Figure 19. With the right hand, insert the operating slide spring guide, or a similar tool, into the hole in the hammer spring plunger from right to left and pull back until the hammer spring plunger is clear of the notch in the hammer (Fig. 19). Swing the hammer spring and plunger to the right to clear the hammer. Ease forward against the force of the spring until the hammer spring plunger clears the trigger housing group. Remove and separate the hammer spring and the hammer spring plunger. If the operating slide spring guide is used, be careful not to bend it.

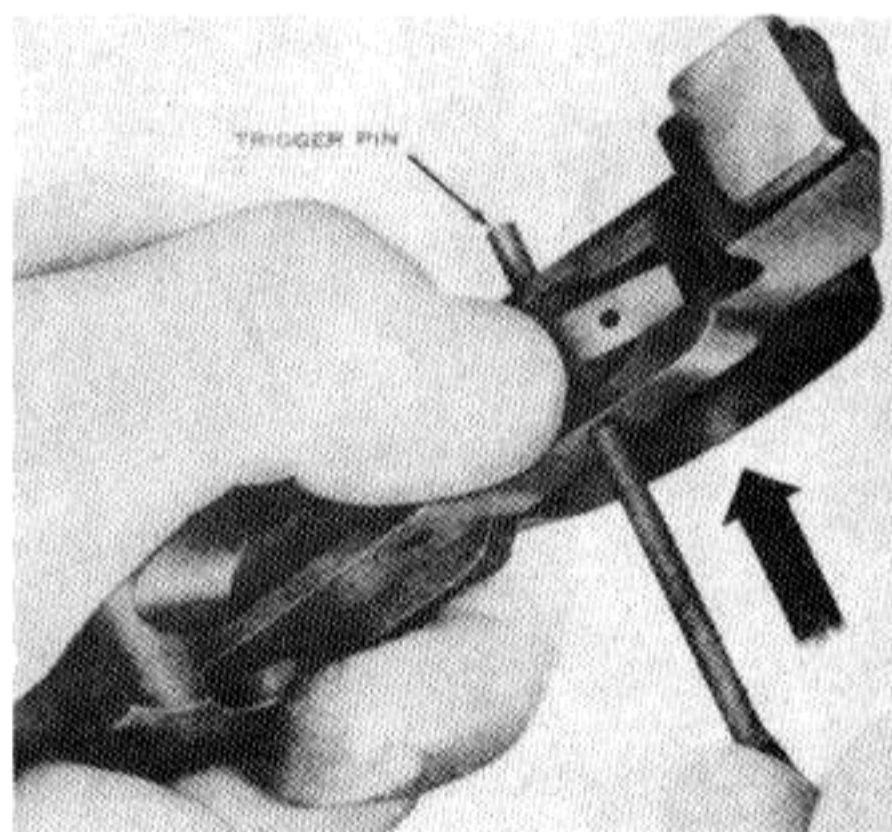

Figure 21. Removing the trigger pin.

*b.* With the operating slide spring guide, drift out the hammer pin (Fig. 20). Remove the hammer and disconnecter.

*c.* Hold the trigger housing group in the left hand as shown in Figure 21, with the thumb pressing down on the sear. Using the small end of the operating slide spring guide, drift out the trigger pin from right to left. Turn the trigger housing group upside down and allow the sear and sear spring to fall out.

*d.* Hold the trigger housing group as shown in Figure 22. Move the trigger forward and then rotate the rear of the trigger upward and forward out of the top of the trigger housing group. Remove the trigger spring from the trigger housing group during this step.

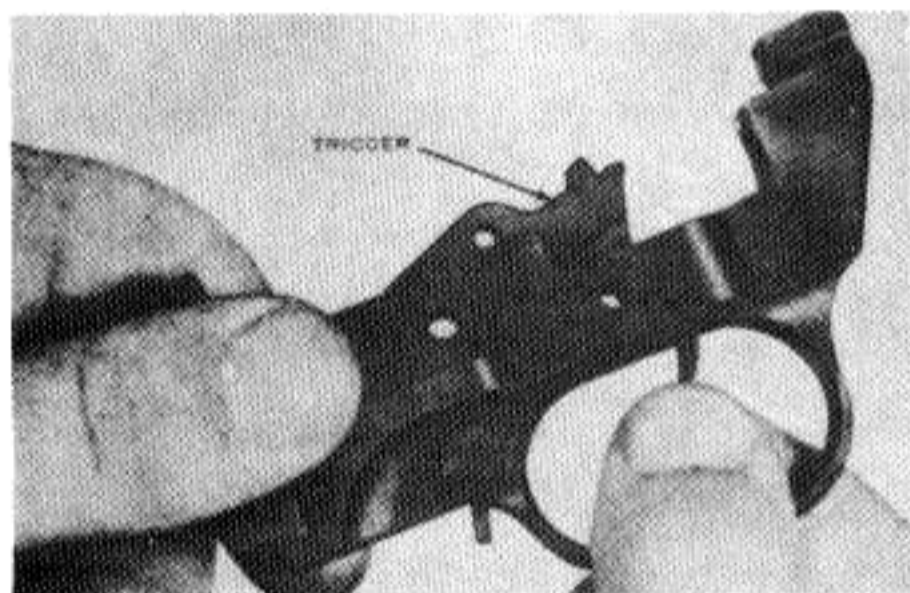

Figure 22. Removing the trigger.

*e.* Hold the trigger housing group in the left hand as shown in Figure 23-A. With the right hand, insert the operating slide spring guide, or a similar tool into the hole in the lower face of the trigger housing — just forward of the bow. Engage the operating slide spring guide forward of the shoulder of the magazine catch retainer plunger and pull the plunger backwards. Place the left thumb against the magazine catch to prevent the magazine catch and the magazine catch plunger assembly (Fig. 23-A), from flying out. Remove the magazine catch and then the magazine catch plunger assembly from the trigger housing (Fig. 23-B).

*f.* Remove the magazine catch retainer plunger assembly with the safety plunger attached (Fig. 24-A). Remove the safety from its aperture (Fig. 24-B). The magazine catch retainer plunger and safety plunger are identical and are positioned on opposite ends of the magazine catch retainer plunger spring. The spring actuates both plungers.

## M1 CARBINE

*g.* In Figure 25, you see the parts of the trigger housing group laid out correctly in the order of disassembly.

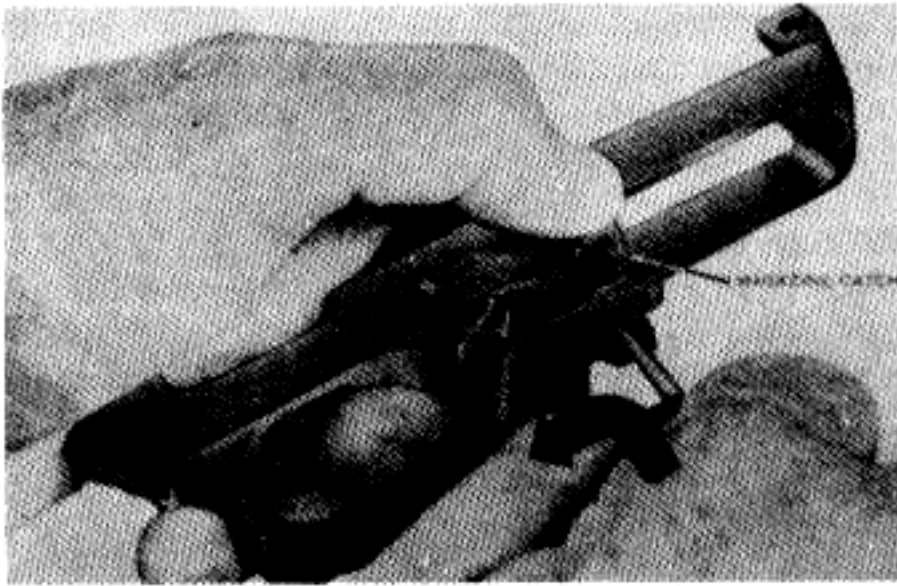

Figure 23-A. Removing the magazine catch.

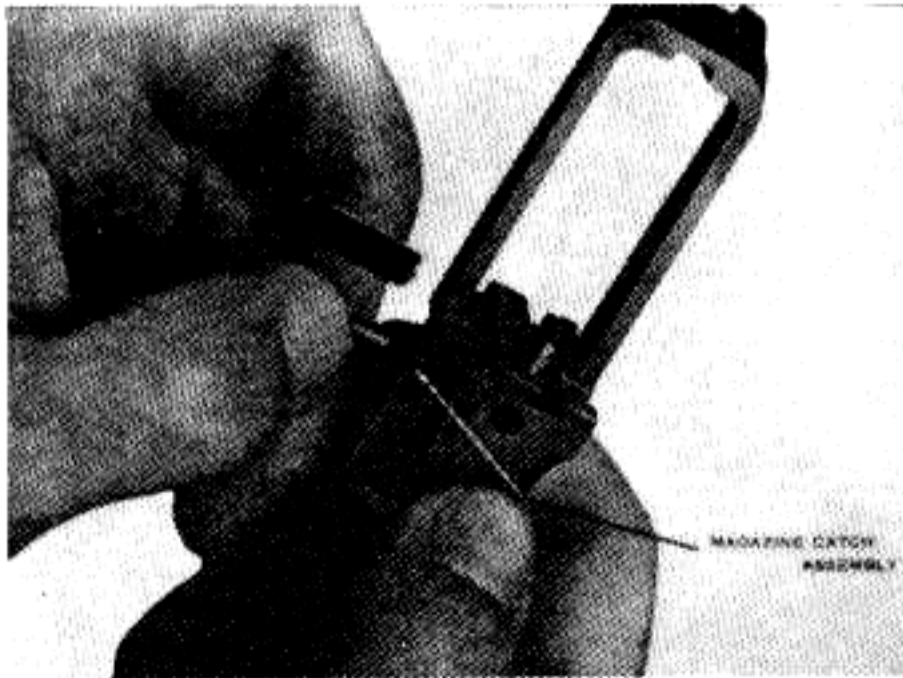

Figure 23-B. Removing the magazine catch plunger assembly.

### ASSEMBLY OF THE TRIGGER HOUSING GROUP (UNDER SUPERVISION ONLY)

To assemble the trigger housing group —  
*a.* Hold the trigger housing as shown in Figure 19. Insert the safety into its aperture in the trigger housing with the trigger notch pointing to the rear.

*b.* If you separated the magazine catch retainer plunger, safety plunger, and magazine catch retainer plunger spring, assemble these parts now. Remember, the two plungers are identical. Insert this assembly into its aperture in the magazine catch guide groove.

*c.* If you separated the magazine catch spring and plunger, assemble these parts now, and then place the assembly in its well in the trigger guard housing. The loose end of the magazine catch spring is inserted first, with the plunger facing outward. Replace the magazine catch into its guide groove in the forward face of the trigger housing with the fingerpiece facing to the rear. Move the magazine catch to the left against its plunger. Grasp the trigger housing as shown in Figure 26. Pull the magazine catch retainer plunger back into the aperture in the trigger housing and at the same time, push the magazine catch completely to the left. The magazine catch retainer plunger will click into position in its recess in the magazine catch, holding the magazine catch in its guide groove. Operate the safety and magazine catch a few times to test the assembly.

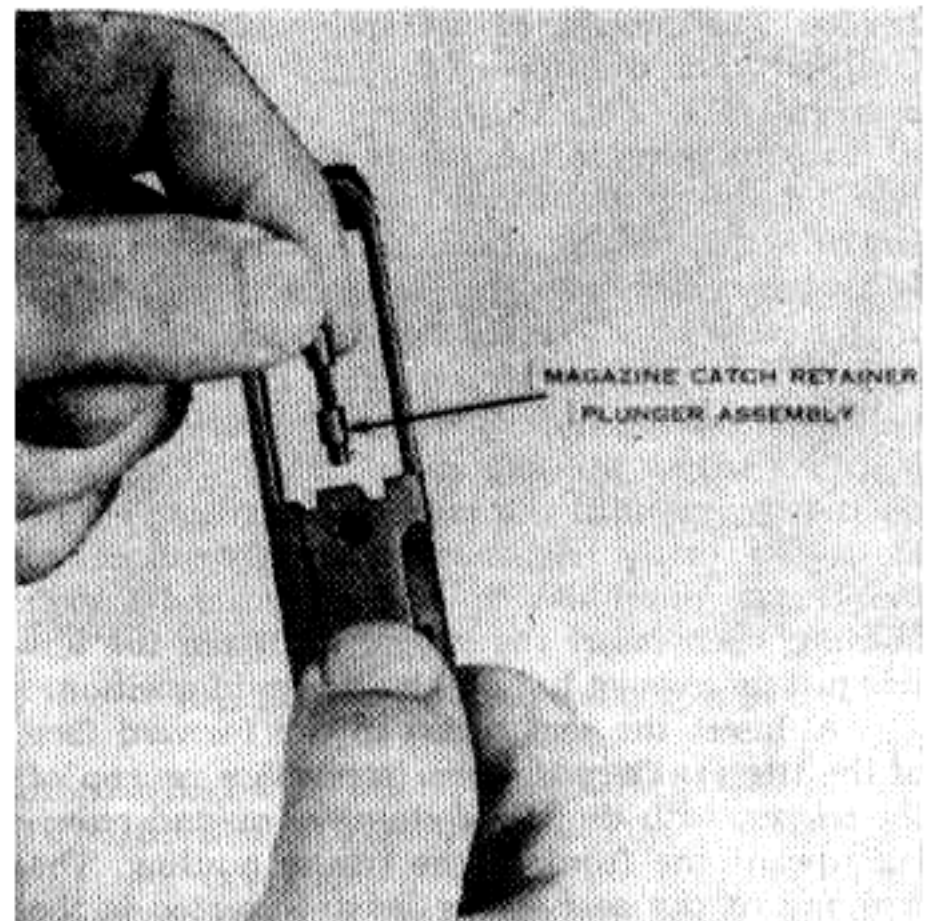

Figure 24-A. Removing the magazine catch retainer plunger assembly.

*d.* Hold the rear of the trigger housing group in your left hand. Grasp the long forward end of the trigger with the right thumb and forefinger. Hold the trigger level and place it down into the trigger housing group with the fingerpiece projecting part way through the floor of the trigger housing. Grasp the fingerpiece with the thumb and forefinger of the left hand which is holding the trigger housing group (Fig. 27). Position the trigger spring to the rear of the trigger so that the loop end rests in the slot in the rear top face of the

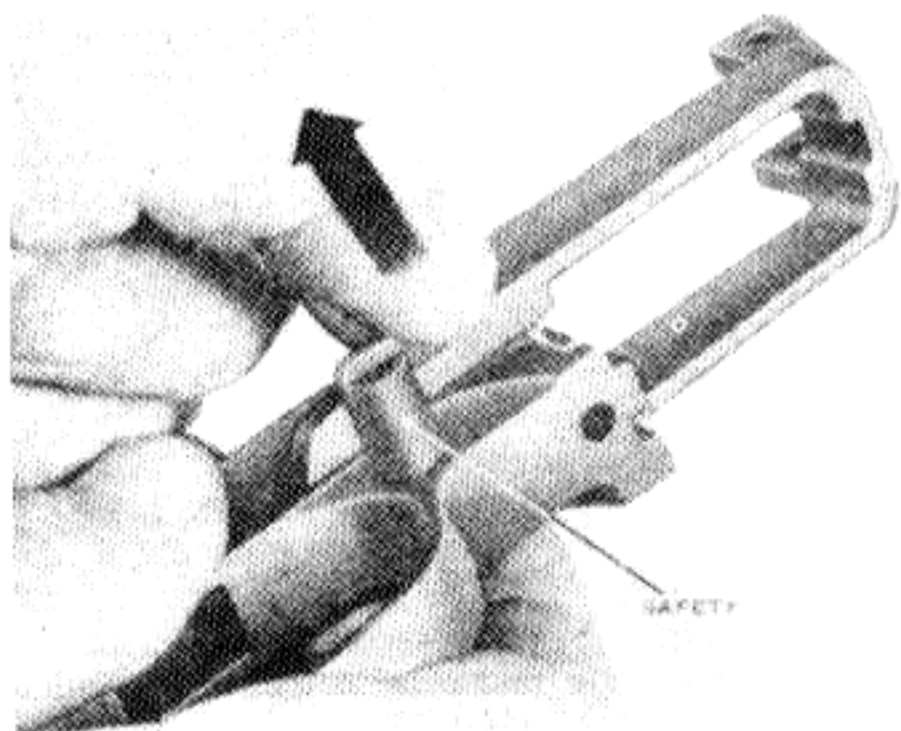

Figure 24-B. Removing the safety.

trigger. The prongs of the spring point upward and bear upon the upper edge of the trigger spring aperture (Fig. 28). This aperture is the lower of the two apertures in the rear of the trigger housing. With the right forefinger over the trigger and trigger spring to hold them in position, press down and to the rear, allowing the fingerpiece of the trigger to rotate forward and upward. When the coils of the trigger spring are seated in the aperture, pull back on the fingerpiece of the trigger to seat it in the trigger housing group. Do not pull back on the trigger until the coils of the trigger spring are seated, or the trigger spring will fly out. Align the trigger pin holes in the trigger and trigger housing, then insert the trigger pin from the left side just far enough to hold the trigger in position.

e. Insert the sear spring in the forward face of the trigger. Place the sear in position on top of the trigger, with the raised shoulder up and pointing toward the front of the trigger housing. The free end of the sear spring must be seated in the rear face of the sear. Hold the trigger housing

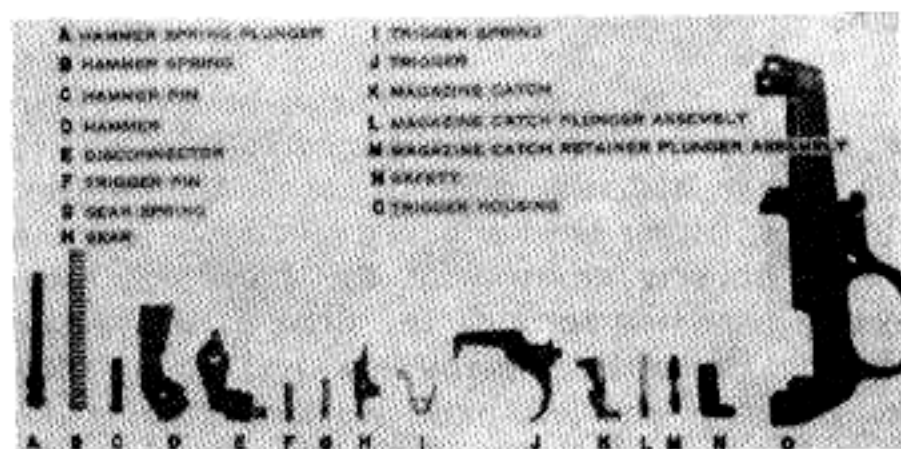

Figure 25. Layout of the parts of the trigger housing group.

group in the left hand as shown in Figure 29, with the forefinger pressing against the trigger pin. Force the sear to the rear by applying pressure against its raised shoulder with the operating slide spring guide. At the same time, maintain pressure against the rear of the sear with a finger of the right hand and align the trigger pin holes. Seat the trigger pin.

f. Replace the disconnecter, making sure that its rear end is on top of the sear (Fig. 30). Replace the hammer with its long end up and curving to the rear (Fig. 31). Engage the sear notch of the hammer with the sear nose and rotate the hammer

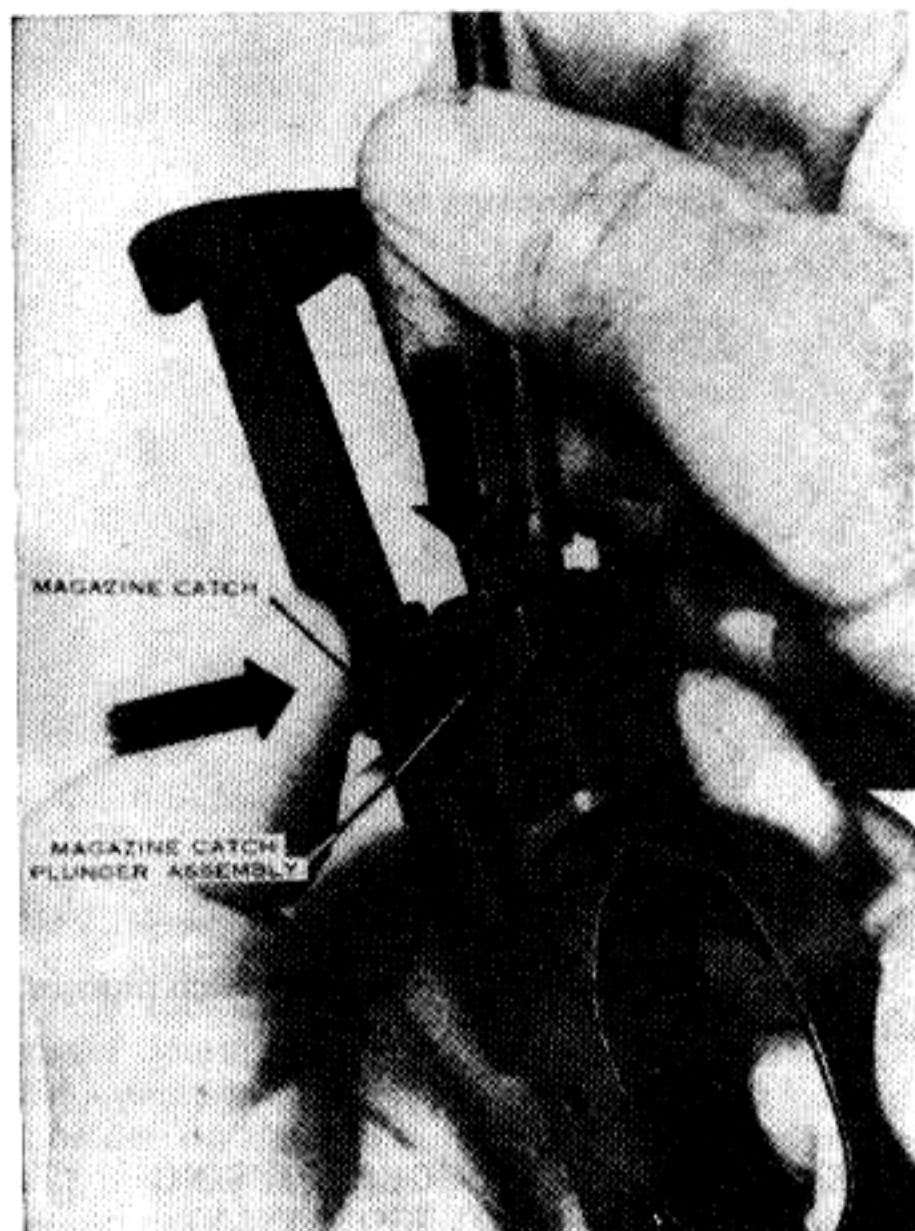

Figure 26. Replacing the magazine catch.

to its rearward (cocked) position. Align the hammer pin holes and replace the hammer pin. The operating slide spring guide may be used to align the hammer pin holes.

g. Squeeze the trigger and move the hammer forward to its fired position. Assemble the hammer spring and hammer spring plunger. Seat the free end of the hammer spring in its well in the trigger housing group with the head of the hammer spring plunger on the right side of the hammer. Insert

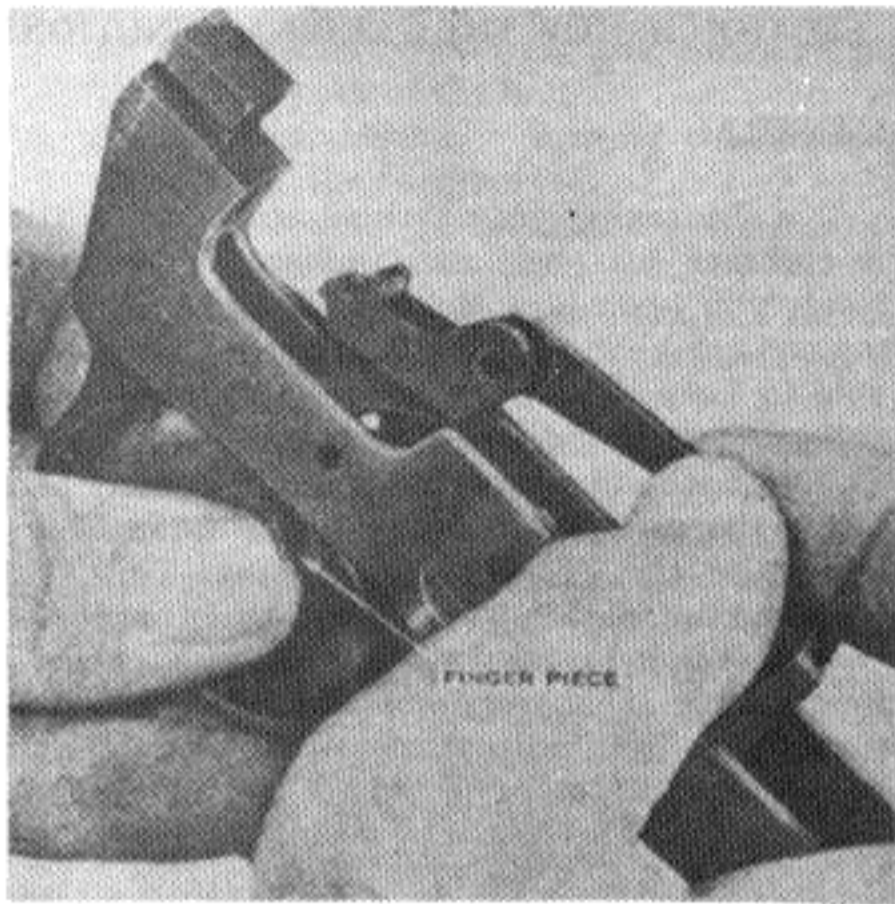

Figure 27. Replacing the trigger.

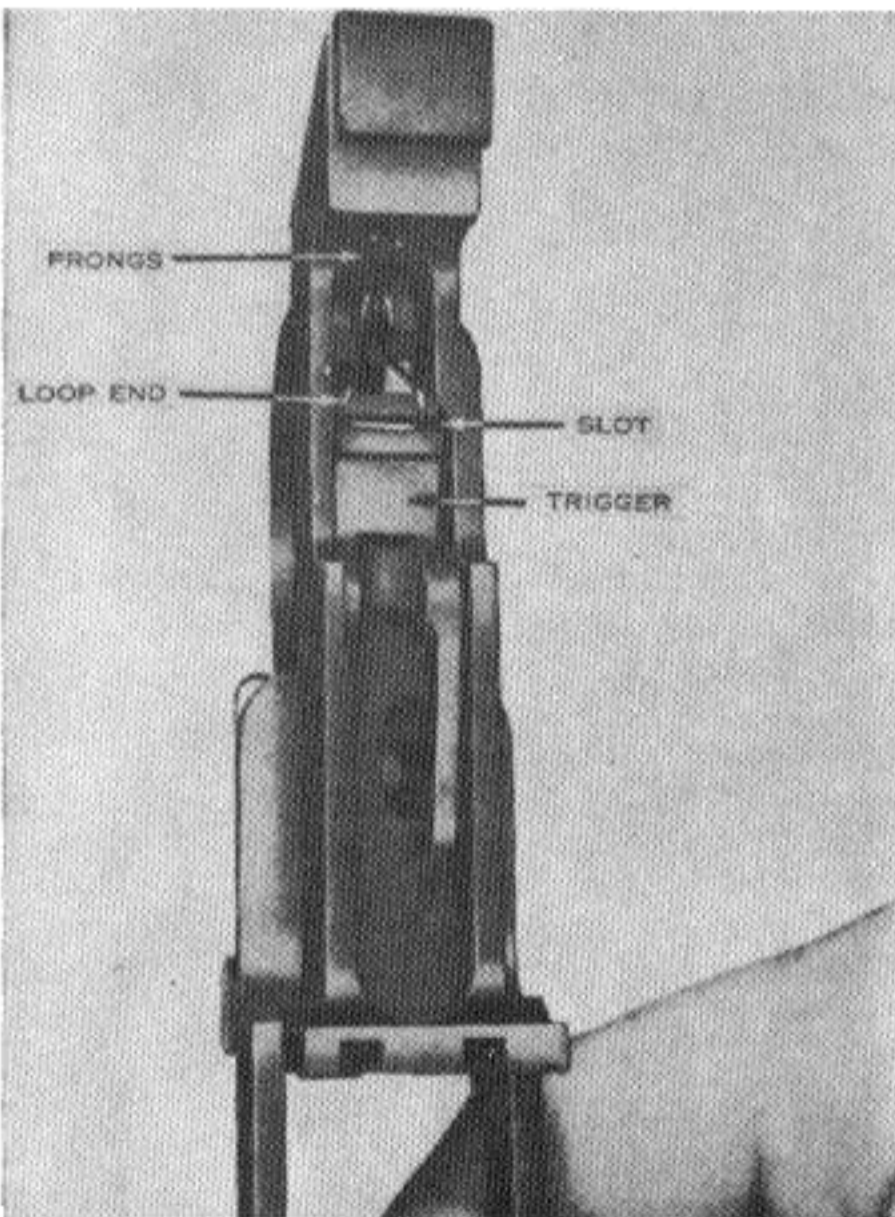

Figure 28. Trigger spring in proper position.

the operating slide spring guide into the hole in the hammer spring plunger. Pull the hammer spring plunger back against the force of the hammer spring and seat it into the well in the hammer.

**DISASSEMBLY OF THE OPERATING SLIDE (UNDER SUPERVISION ONLY)**

The operating slide stop is the only removable part of the operating slide group. To disassemble the operating slide group —

- a. Grasp the operating slide as shown in Figure 32. Using the operating slide spring guide, push out the operating slide stop, small end first.
- b. Remove the operating slide stop spring from the well in the operating slide.

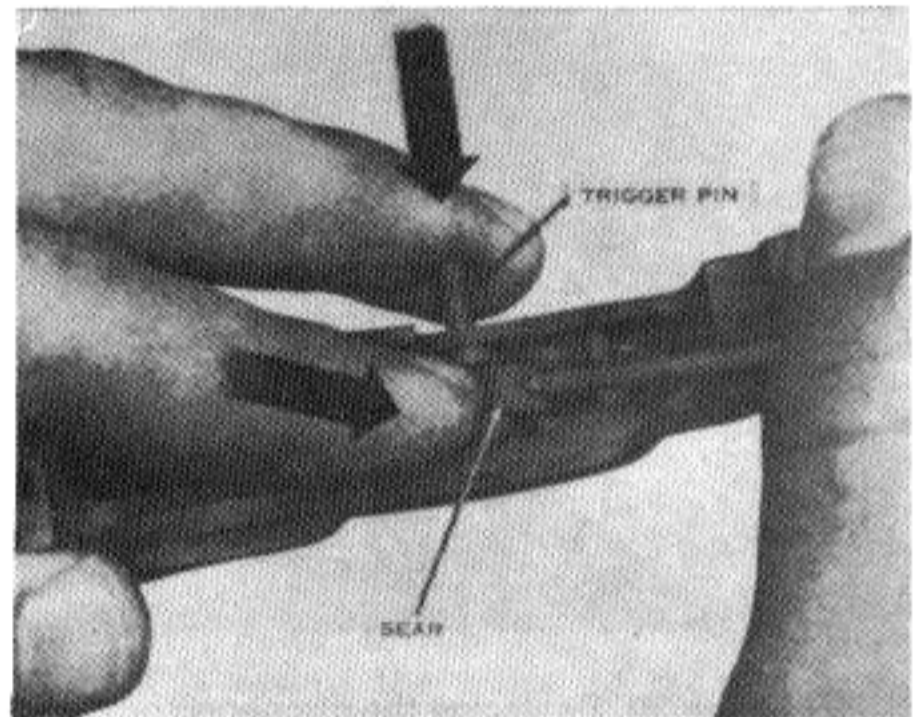

Figure 29. Replacing the trigger pin.

**ASSEMBLY OF THE OPERATING SLIDE (UNDER SUPERVISION ONLY)**

To assemble the operating slide group —

- a. Replace the operating slide stop spring into its well in the rear of the slide.

- b. Replace the operating slide stop, large end first, into the bottom of its well. Using the operating slide spring guide, depress the operating slide stop spring and seat at the operating slide stop.

**DISASSEMBLY OF THE MAGAZINE (UNDER SUPERVISION ONLY)**

To disassemble the magazine —

- a. Grasp the magazine in the left hand with the base up and with the rounded end of the base

SECTION II. HOW THE CARBINE FUNCTIONS

GENERAL

a. By taking your carbine apart and putting it together you become familiar with its parts. Next, you learn how these parts function. If you understand how your carbine works, you will be able to keep it in working order. This knowledge will give you confidence in your carbine.

b. Each time a cartridge is fired, many parts inside the carbine work in a given order. This is known as the *cycle of functioning*. This cycle is almost the same in all semi-automatic weapons.

c. To help you understand the cycle of functioning, it is broken down into eight basic steps. Keep in mind that more than one step may be occurring at the same time. The steps are listed below in the order that they begin.

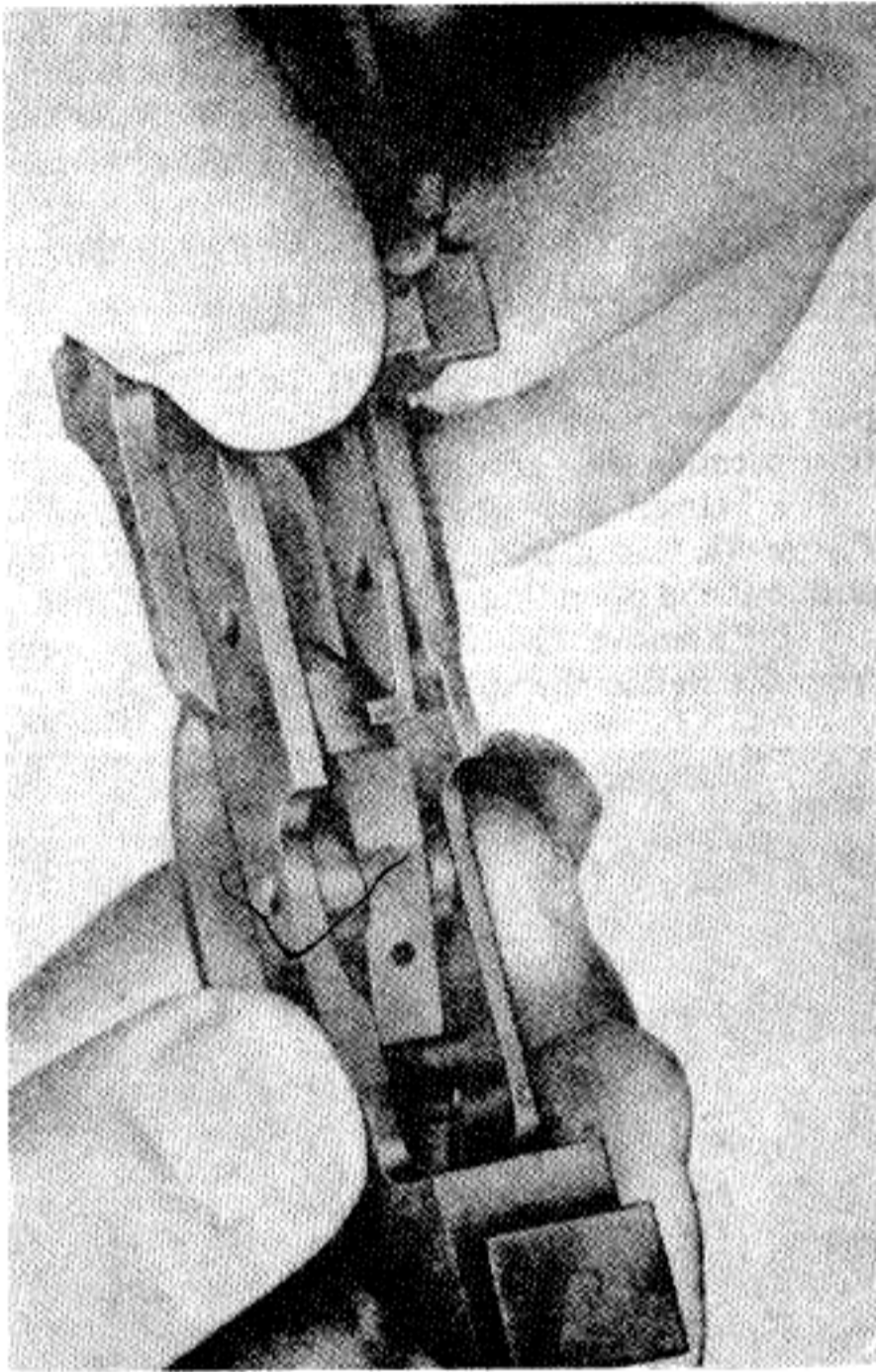

Figure 30. Replacing the disconnecter.

toward your body (Fig. 33). With the left thumb, press up on the rounded end of the magazine base until you can move it from the retaining grooves in the base of the magazine tube by pushing to the left with the operating slide spring guide.

b. Turn the magazine on end and drop out the magazine spring.

c. Allow the follower to slide to the bottom of the magazine tube. Grasp the flange on the follower and rotate the follower out of the magazine tube.

ASSEMBLY OF THE MAGAZINE (UNDER SUPERVISION ONLY)

To assemble the magazine, proceed in the reverse order of disassembly.

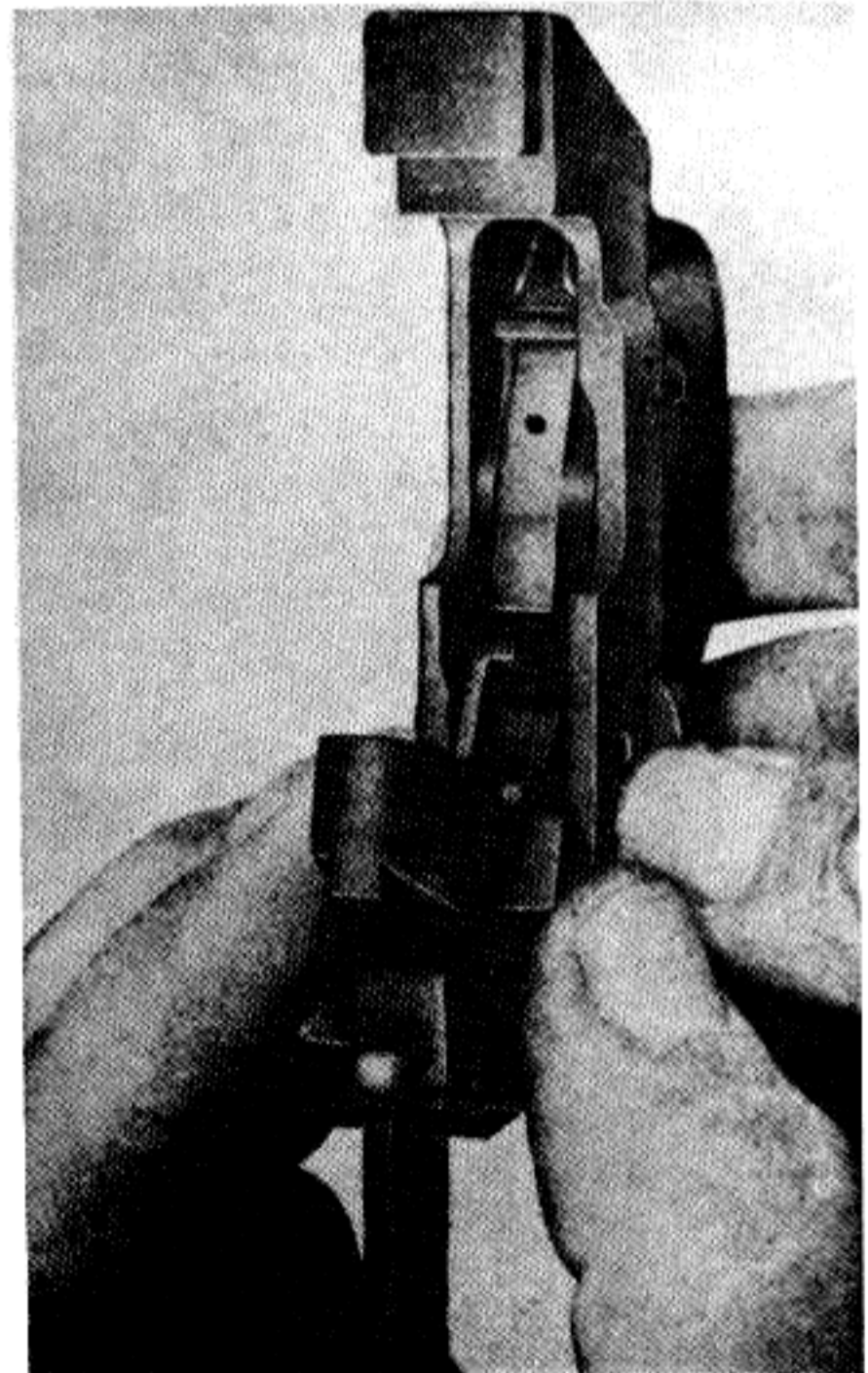

Figure 31. Replacing the hammer.



- (1) Feeding — moving the cartridge into the path of the bolt.
- (2) Chambering — moving the cartridge into the chamber.
- (3) Locking — locking the bolt in the receiver.
- (4) Firing — driving the firing pin forward to strike the primer, which sets off the cartridge.
- (5) Unlocking — unlocking the bolt from the receiver.
- (6) Extraction — removing the empty cartridge case from the chamber.
- (7) Ejection — throwing the empty cartridge case from the carbine.
- (8) Cocking — pushing the hammer into the cocked position.

d. During the discussion of functioning of the trigger housing group you will find the names of many new surfaces and parts. To help you locate these parts and surfaces, Figures 34 through 37 have been included.

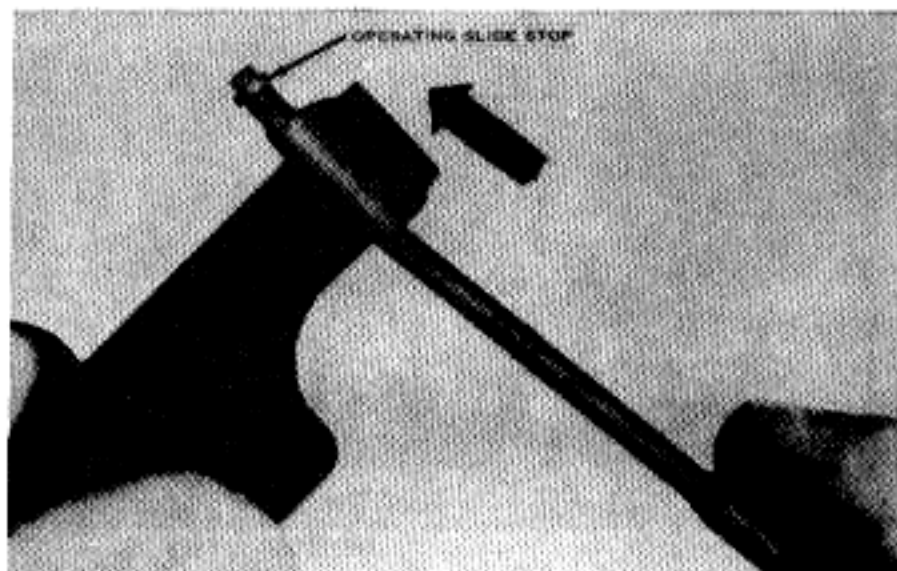

Figure 32. Removing the operating slide stop.

### FUNCTIONING OF THE TRIGGER HOUSING GROUP (SEMI-AUTOMATIC SETTING)

a. Since the carbine begins to function when you squeeze the trigger, you first learn how the trigger housing group works (Fig. 38).

- (1) Remove the trigger housing group and cock the hammer. The hammer is held in the cocked position by the sear nose engaging the sear notch on the hammer. Hold your left thumb over the hammer and slowly squeeze the trigger. Notice how the trigger lip moves upward and contacts the rear of the sear. This action forces the sear to pivot about

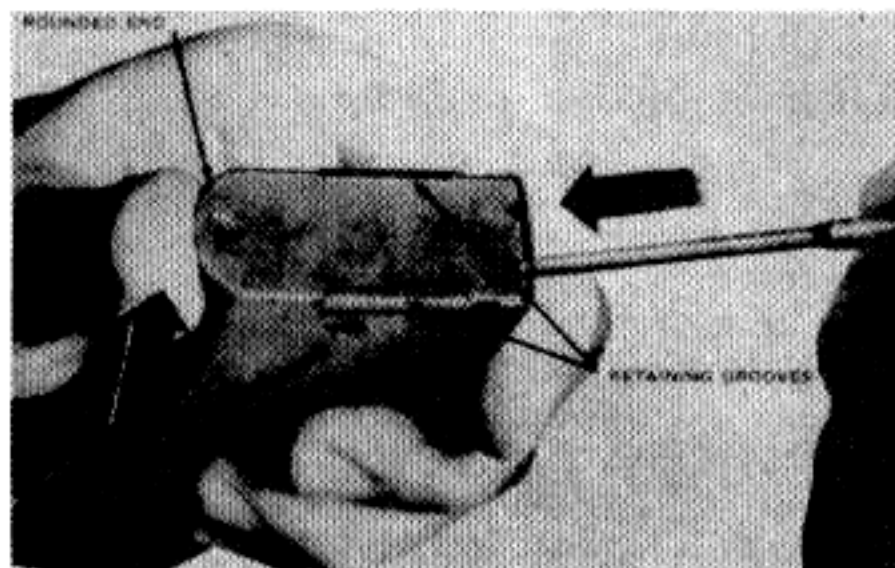

Figure 33. Removing the magazine base.

the trigger pin. As the sear pivots, its forward end moves downward and is disengaged from the hammer. The hammer is forced forward by the expanding hammer spring. This happens each time the trigger is squeezed if you release your finger from the trigger after each shot is fired.

- (2) There must also be a way of stopping the hammer from going forward, even if you keep your finger pressed on the trigger after each shot. This is accomplished by the sear nose engaging in the sear notch as the hammer starts forward. The action causes the sear to move to the rear a short distance against the action of the sear spring. The sear cannot move completely to the rear because it is blocked by the trigger lip. Now release the trigger and squeeze it again, holding it to the rear. Cock the hammer slowly and see how the sear moves to the rear a short distance and the sear nose engages the

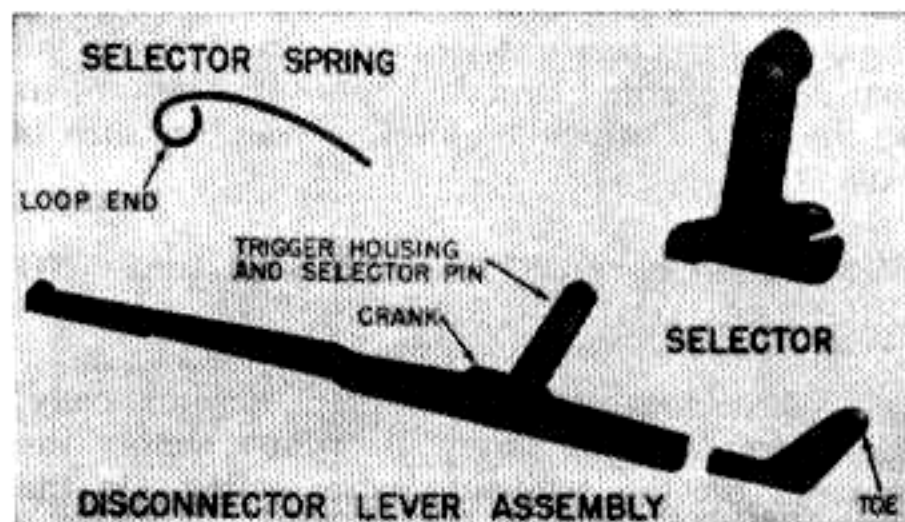

Figure 34. Trigger housing group parts.

## M1 CARBINE

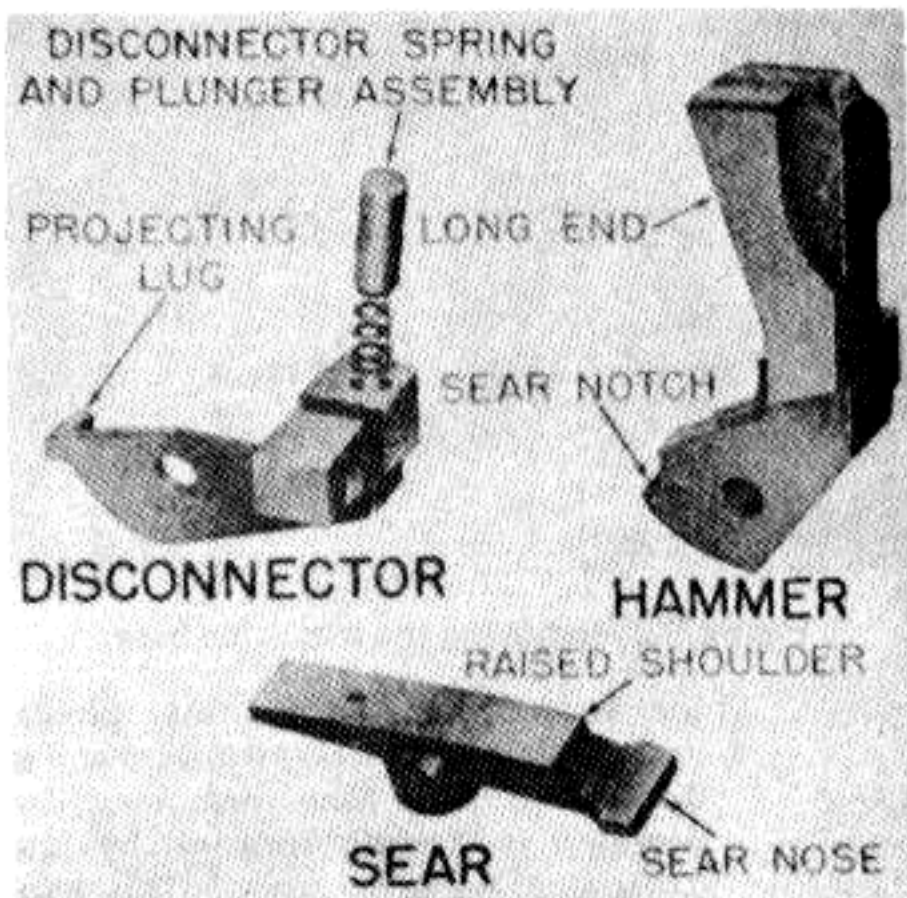

Figure 35. Trigger housing group parts.

sear notch, holding the hammer back. Release the trigger slowly. As you do this, the sear moves farther to the rear and the hammer moves forward a short distance and then stops. The hammer is still held in the cocked position by the sear nose engaging the sear notch. This combination holds the hammer to the rear each time a round is fired.

b. As you apply pressure on the trigger it pivots about the trigger pin. This movement is divided into a *slack* portion and a *squeeze* portion. Cock the hammer and squeeze the trigger lightly. Notice that it moves easily until the trigger lip touches the rear end of the sear. This movement, until the trigger lip contacts the sear, is called the *slack*. Increased pressure is required to move the trigger from the time the trigger lip contacts the rear of the sear until the sear nose releases the sear notch on the hammer. This second movement of the trigger which requires heavier pressure is called the *squeeze*.

### FUNCTIONING OF THE TRIGGER HOUSING GROUP (AUTOMATIC SETTING)

When the carbine is fired automatically, the trigger housing group functions almost the same as on the semi-automatic setting. On the automatic setting, however, each time the operating slide moves forward the rear end of the

disconnecter lever is rotated upward causing the disconnecter to pivot about the hammer pin. When the trigger is held to the rear, the rear of the disconnecter contacts the raised shoulder of the sear and forces the forward end of the sear down, disengaging the sear nose from the hammer. The hammer moves forward actuated by the hammer spring, and the carbine fires. If the trigger is released, the sear moves to the rear under action of the hammer spring, and the rear of the disconnecter cannot contact the forward end of the sear. The sear nose remains engaged with the hammer, the hammer is held to the rear, and the carbine stops firing.

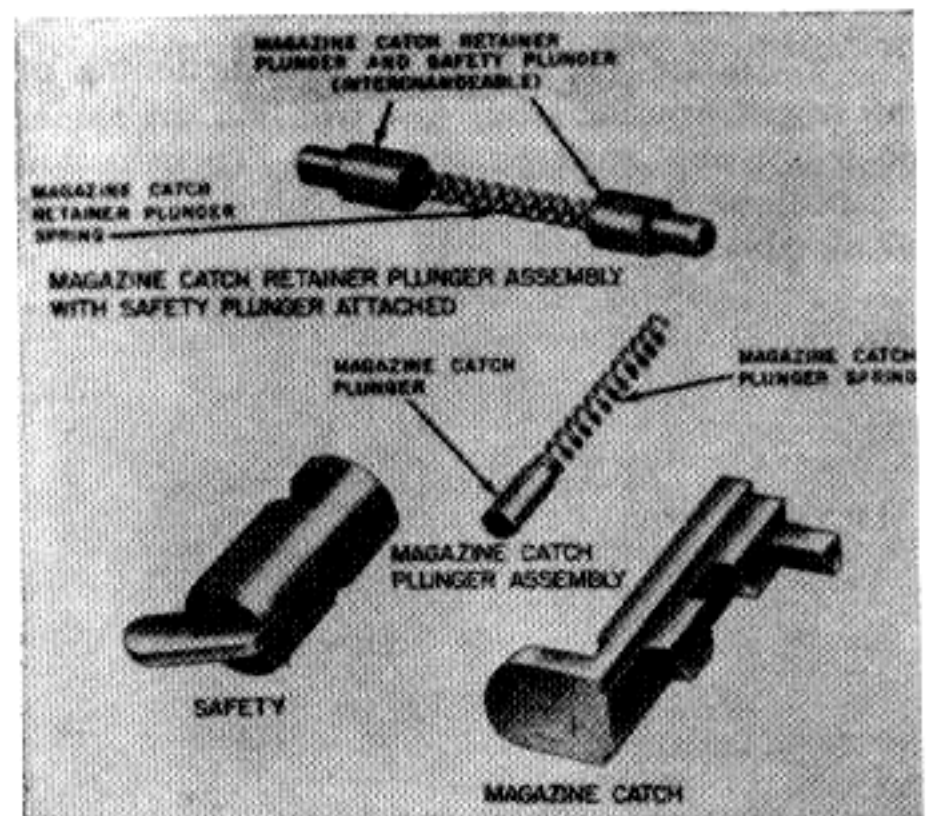

Figure 36. Trigger housing group parts.

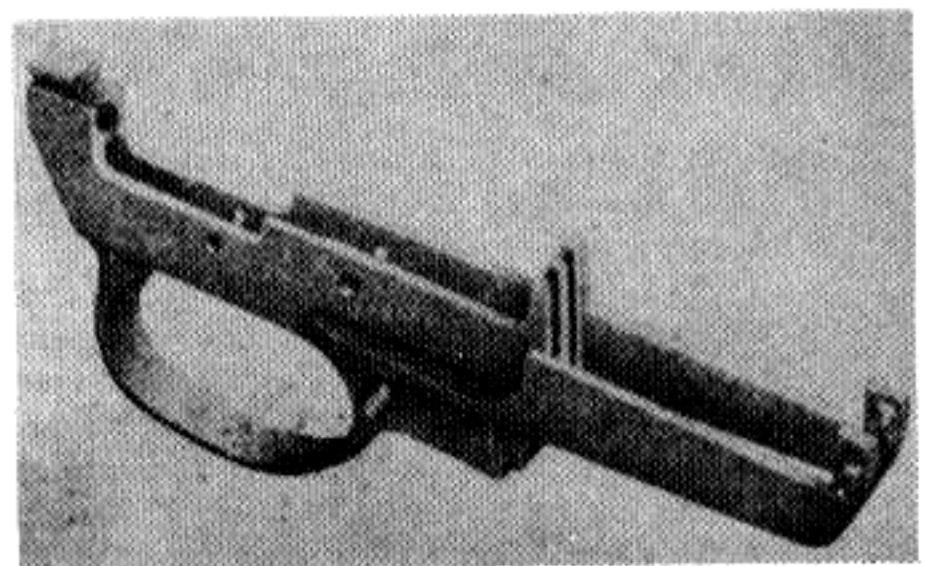

Figure 37. Trigger housing group parts.

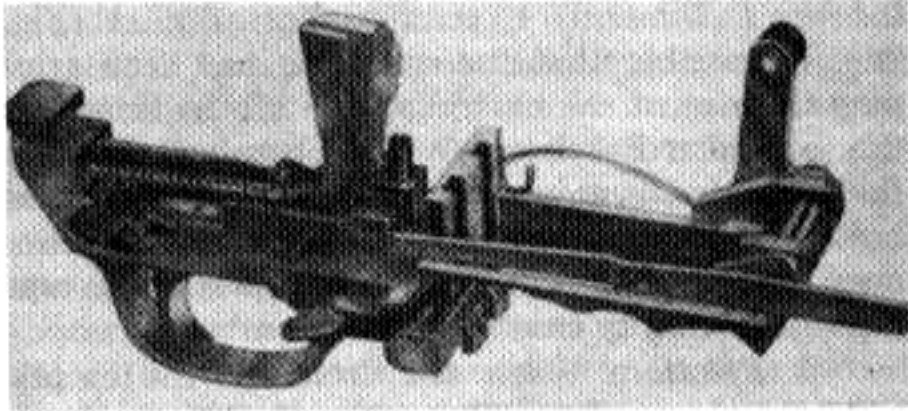

Figure 38. Functioning of trigger housing group.

### FUNCTIONING OF THE CARBINE

The action of the working parts during the *functioning cycle* is divided into two phases with certain steps of each phase going on at the same time. They are listed below in the order in which they start.

*a.* The *first phase* is the ACTION DURING THE FORWARD MOVEMENT OF THE OPERATING PARTS.

- (1) Chambering.
- (2) Locking.
- (3) Alignment of the firing pin.
- (4) End of the forward movement.

*b.* The *second phase* is the ACTION DURING THE REARWARD MOVEMENT OF THE OPERATING PARTS.

- (1) Action of the gas.
- (2) Action of the operating slide and spring.
- (3) Unlocking.
- (4) Withdrawal of the firing pin.
- (5) Extraction.
- (6) Ejection.
- (7) Cocking.
- (8) Feeding.
- (9) End of the rearward movement.

### FUNCTIONING DURING FORWARD MOVEMENT OF OPERATING PARTS (SEMI-AUTOMATIC SETTING)

*a. Chambering.* As the operating slide and bolt move forward, pushed by the compressed operating slide spring, the bolt strips off the top round in the magazine and shoves it into the chamber. When the bolt reaches its forward position, the rim of the cartridge is gripped by the extractor. The base of the cartridge forces the ejector into the bolt, compressing the ejector spring.

*b. Locking.* When the bolt is all the way forward, the rear camming surface in the hump of the operating slide forces the operating lug of the

bolt downward, making the bolt rotate clockwise. The bolt is locked as the locking lugs on both sides of the bolt engage the locking recesses in the receiver.

*c. Alignment of the Firing Pin.* Slightly before the bolt reaches its foremost position, the tang of the firing pin contacts the bridge of the receiver, stopping the forward movement of the firing pin. When the bolt is turned and fully locked, the tang of the firing pin is aligned with the slot in the bridge of the receiver and may be driven forward by the hammer. This is a safety feature to make sure that the bolt is fully locked before the live cartridge can be fired. Should the hammer fall before the bolt is fully locked, the bolt camming lug on the hammer will strike the cocking cam on the bolt causing the bolt to rotate to its locked position.

*d. End of the Forward Movement.* After the bolt has been turned into the locked position, the operating slide continues forward a short distance. The forward movement of the operating parts ends when the inside of the heavy portion of the operating slide has driven the gas piston into the gas cylinder.

### FUNCTIONING DURING REARWARD MOVEMENT OF OPERATING PARTS (SEMI-AUTOMATIC SETTING)

*a. Action of the Gas.* When a cartridge is fired, the gas formed by the burning powder provides

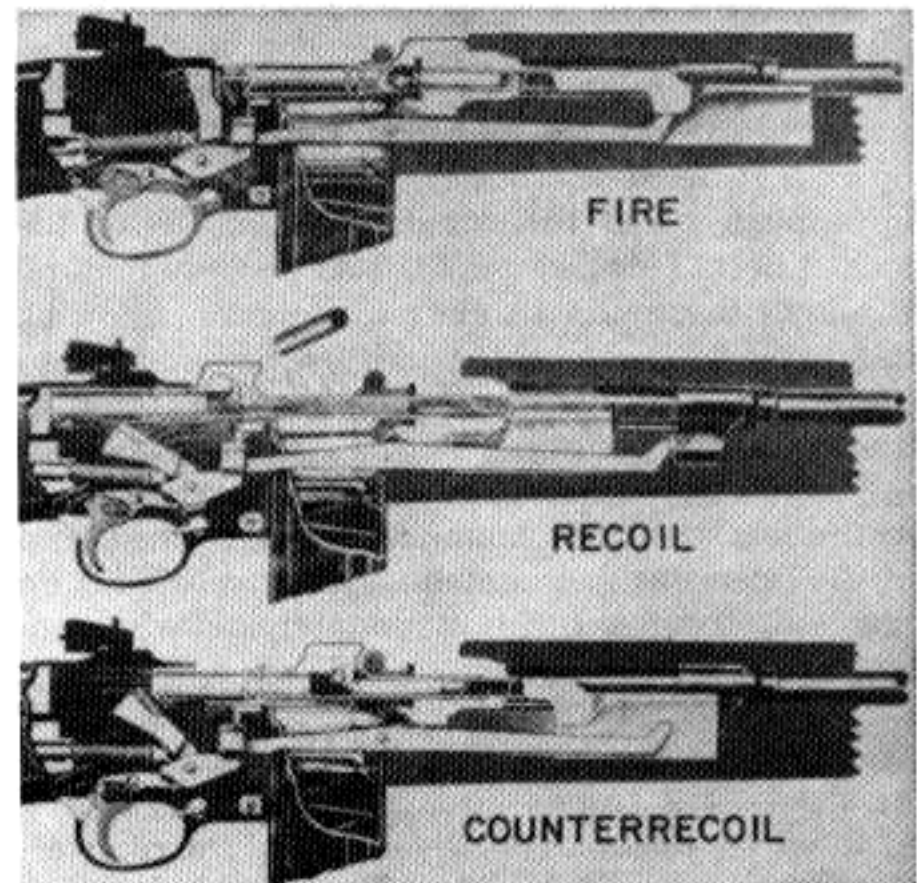

Figure 39. Functioning of operating parts (semi-automatic setting).

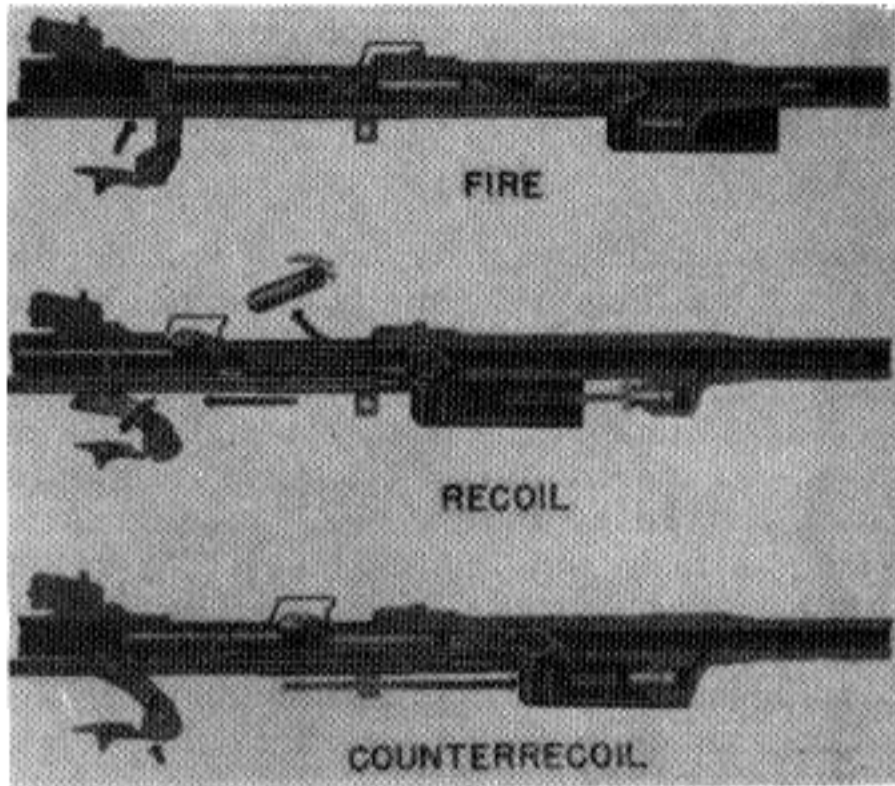

Figure 40. Action of the gas.

the force for the rearward movement of the operating parts. A chamber pressure of approximately 40,000 pounds per square inch is generated and the bullet is forced through the barrel by the expanding powder gases. A small part of this gas, seeking the easiest means of escape, expands through the gas port into the gas cylinder and strikes the piston with a sudden force, driving the operating slide to the rear (Fig. 40).

*b. Action of the Operating Slide and Spring.* As the operating slide starts to the rear, the operating slide spring begins to be compressed. The operating slide moves to the rear approximately five-sixteenth of an inch before contacting the operating lug of the bolt. This allows it to build up enough speed to overcome the inertia of the locked bolt. This *free play* is also a safety feature. It allows the bullet to clear the muzzle, allowing the pressure inside the barrel to be reduced to outside pressure before the bolt begins to unlock. This prevents a blowback of gases into your face.

*c. Unlocking.* As the operating slide continues to the rear, the front camming surface in the hump of the operating rod contacts the operating lug on the bolt, turning the bolt counterclockwise, unlocking it.

*d. Withdrawal of the Firing Pin.* This action occurs at the same time the bolt is being unlocked. As the bolt is turned counterclockwise, the tang of the firing pin contacts the bridge of the receiver. The firing pin is forced to the rear, withdrawing the striker of the firing pin into the face of the bolt.

*e. Extraction.* Extraction occurs next (Fig. 41). Remember that the extractor has been gripping the rim of the cartridge case all the time that the cartridge has been in the chamber. Initially the cartridge is loosened in the chamber as the bolt unlocks, due to a very slight rearward movement of the bolt. As the bolt continues to the rear it pulls the empty case from the chamber.

*f. Ejection.* When the front of the empty cartridge case clears the rear of the chamber, the ejector (which has been continually pushing against the base of the case) ejects the empty case from the receiver by the action of the expanding ejector spring (Fig. 41).

*g. Cocking.* As the bolt moves to the rear, it forces the hammer rearward and downward into the cocked position.

*h. Feeding.* When the bolt in its rearward movement clears the top round in the magazine, the follower, through the action of the compressed magazine spring, moves the top cartridge up into the path of the bolt.

*i. End of the Rearward Movement.* The rearward movement ends when the heavy portion of the operating slide contacts the front of the receiver.

#### ACTION OF AUTOMATIC MECHANISM, GENERAL

*a. Semi-automatic Setting.* When the selector is in the rear (semi-automatic) position, the disconnecter lever is disengaged and is not involved with the functioning of the carbine. Since the disconnecter lever is lowered and its toe cannot contact the camming surface on the operating slide, the selector is held on either setting by the locking action of the selector spring.

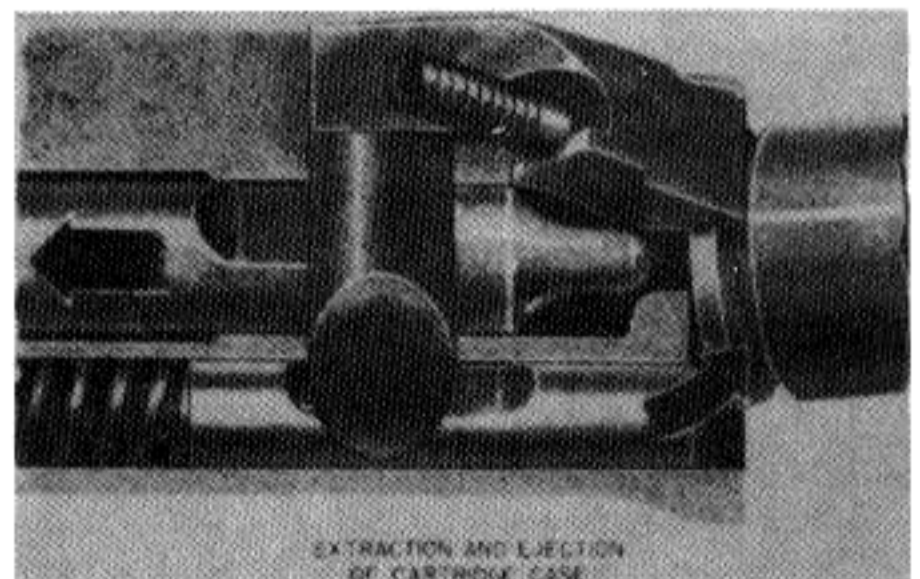

Figure 41. Extraction and ejection.

*b. Automatic Setting.* When the selector is pushed forward, it rotates the trigger housing and selector pin. The crank on the trigger housing and selector pin rotates upward forcing the disconnecter lever upward. Assuming that the operating slide is forward when the disconnecter lever moves upward, the toe of the disconnecter lever contacts the camming surface on the operating slide. The toe of the disconnecter lever is forced down, making the disconnecter lever pivot on the trigger housing and selector pin. The rear end of the disconnecter lever is raised. This raises the front end of the disconnecter, which compresses the disconnecter spring and plunger assembly. The disconnecter pivots about the hammer pin, rotating downward the projecting lug on the rear of the disconnecter. If the hammer were cocked and the trigger squeezed, the disconnecter would bear against the raised shoulder of the sear. The forward end of the sear would be depressed and the hammer would be released. However, with the trigger released, the sear has moved far enough to the rear so that the disconnecter cannot contact the sear. Hence, the hammer is not released. The sear is forced to the rear by the hammer spring.

#### FUNCTIONING DURING FORWARD MOVEMENT OF OPERATING PARTS (AUTOMATIC SETTING) (FIG. 42)

*a.* The action as the operating slide moves forward is the same as on the semi-automatic setting (Page 28) and (Fig. 39), up to the time the camming surface on the operating slide contacts the toe of the disconnecter lever. At this point, the operating slide cams down the toe of the disconnecter lever. This raises the rear end of the disconnecter lever, which is in contact with the disconnecter. The forward end of the disconnecter is cammed upward. The disconnecter rotates about the hammer pin, and the projecting leg on the rear of the disconnecter moves downward. With the trigger still held back, the projecting lug of the disconnecter presses against the raised shoulder of the sear and the sear nose is disengaged from the hammer. The hammer spring then rotates the hammer forward, and the carbine fires. This happens every time the operating slide moves forward if pressure is maintained on the trigger (see next column).

*b.* The operating slide cams the toe of the disconnecter lever down during the last five-sixteenth inch for forward movement of the slide. Thus the bolt is fully rotated and locked before the carbine is fired. As in the M1 carbine, the

bridge of the receiver keeps the firing pin from moving forward before it should.

*c.* If the trigger is released, the sear will move back over the trigger lip far enough to move the sear out of possible engagement with the disconnecter. Therefore, the disconnecter will not disengage the sear from the hammer. The sear in this case continues to hold the hammer in the cocked position.

#### FUNCTIONING DURING REARWARD MOVEMENT OF OPERATING PARTS (AUTOMATIC SETTING)

*a.* The action up to the time the operating slide starts to the rear is the same as on the semi-automatic setting (Page 28). In the first half inch of rearward movement of the operating slide, the toe of the disconnecter lever slides off the camming surface on the operating slide and rises. Since pressure is no longer held against the disconnecter, the disconnecter spring and plunger assembly forces the front of the disconnecter, as well as rear of the disconnecter lever, downward. As the disconnecter pivots about the hammer pin, the projecting lug on the rear of the disconnecter rises to clear the sear.

*b.* The remainder of the rearward movement is the same as on the semi-automatic setting.

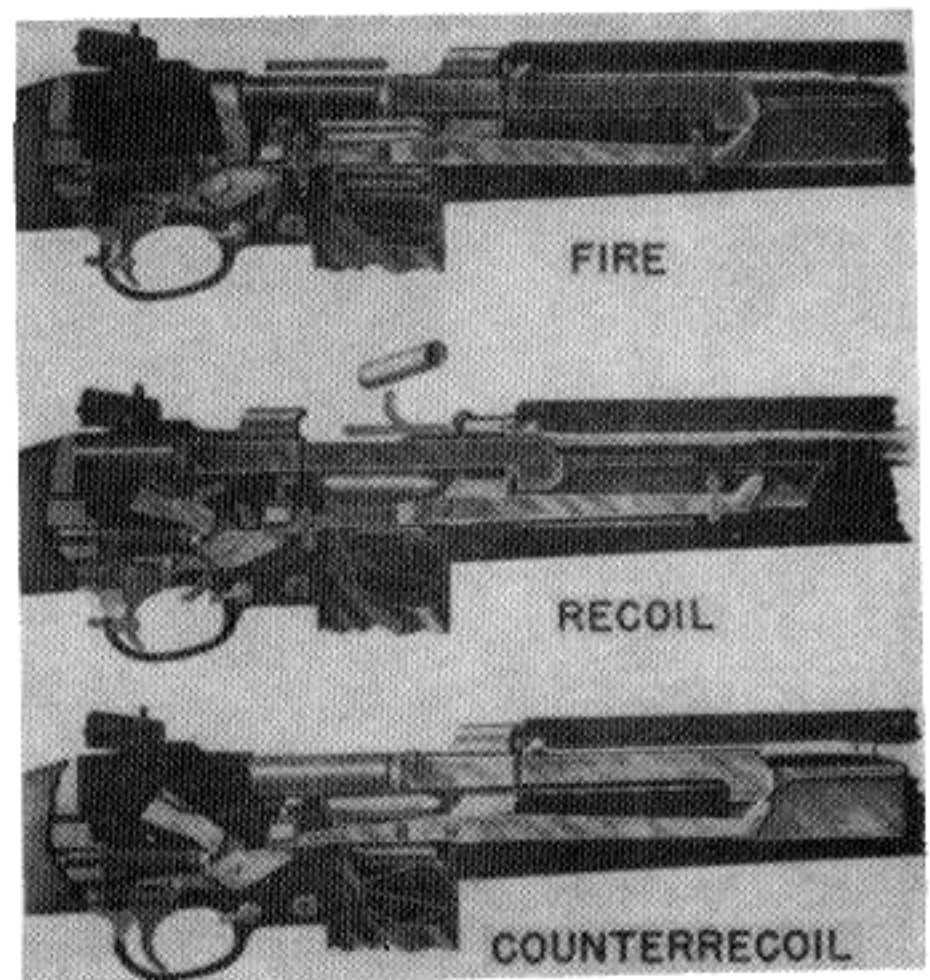

Figure 42. Functioning of operating parts (automatic setting).

## SAFETY FEATURES

*a. The Safety.* To see how the safety works, cock the hammer and rotate the safety downward to the *safe* position. As you rotate the safety downward the trigger notch in the safety rotates to the rear and in its place the solid portion of the safety is exposed to the forward end of the trigger. Attempt to squeeze the trigger. The solid portion of the safety now blocks the forward end of the trigger, preventing the trigger from moving. Since the trigger cannot move, the hammer remains stationary and the weapon does not fire (Fig. 43).

*b. The Bolt and Firing Pin.* A safety feature has been built into the carbine to prevent it from firing unless the bolt is in its locked position. This is done by the action of the bolt camming lug on the hammer against the cocking cam of the bolt. Note on your weapon that if the bolt is not completely rotated to the right into the locked position, the bolt camming lug will not fit in the cocking cam and the hammer cannot hit the tang of the firing pin. If the bolt is not fully locked as the hammer moves forward, the bolt camming lug will rotate the bolt to the right. This action locks the bolt before the hammer can hit the tang of the firing pin. During unlocking, the instant the bolt starts to rotate to the left, the hammer is pushed away from the tang of the firing pin by the action of the cocking cam against the bolt camming lug.

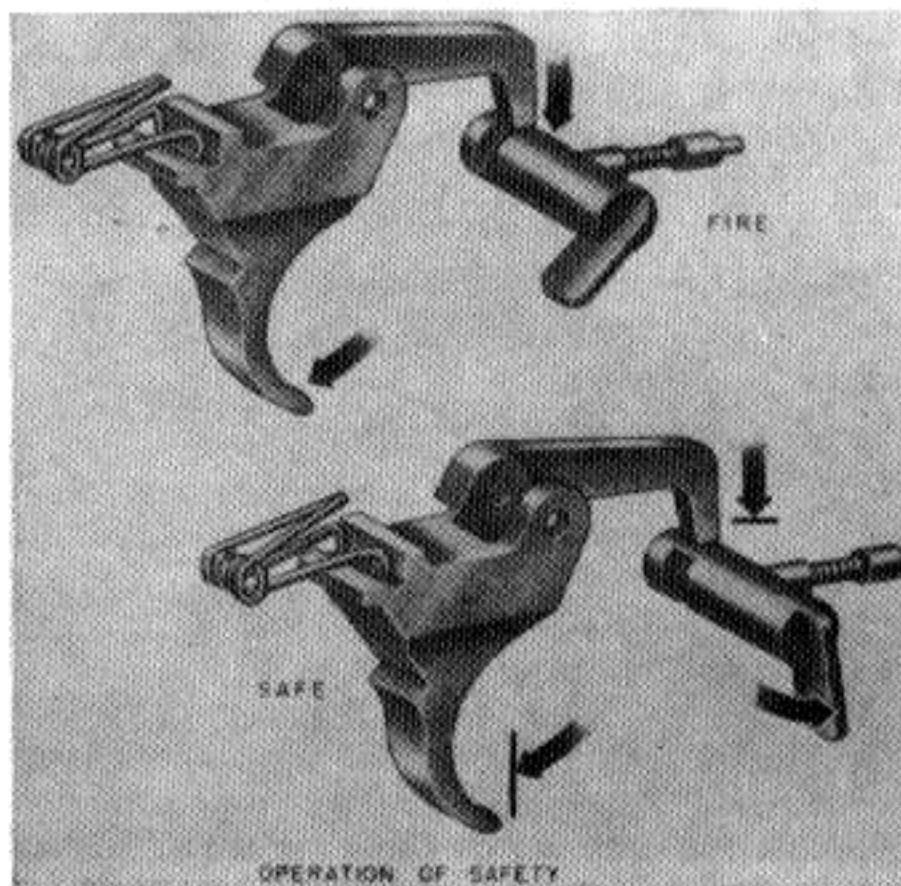

Figure 43. How the safety works.

## SECTION III. OPERATION

## GENERAL

To use your carbine, you must know how to load it with a magazine and with a single cartridge. You must know how to fire it, and, for the safety of yourself and others, how to unload and clear it. In this section, you will be shown how to do these things.

## TO LOAD A MAGAZINE

Insert the desired number of cartridges (maximum of thirty) in the magazine so that the base of each cartridge is close to the rear wall of the magazine.

## TO LOAD THE CARBINE

Holding the carbine with the left hand at the balance, rotate the safety downward. With the right hand, insert a fully loaded magazine into the magazine opening, making sure that it snaps into place. Tap up on the magazine base to be sure it is seated. With the forefinger of the right hand, pull the operating slide quickly to the rear and release it, closing the bolt. Striking the operating slide handle sharply with the heel of the right hand helps to close and lock the bolt.

## TO UNLOAD THE CARBINE

*a.* To unload the carbine, move the safety to the safe setting, remove the magazine and lock the bolt in the open position. There are two methods for removing the magazine.

*b.* To unload a single round from the chamber, hook the right forefinger over the operating slide handle and pull the operating slide to the rear. This extracts and ejects the round.

## TO OPERATE THE CARBINE AS A SINGLE LOADER

With the receiver empty, pull the operating slide to the rear and lock it in this position by depressing the operating slide stop. With the right hand, place one round in the chamber, seating it with the thumb. With the right forefinger, pull the operating slide slightly to the rear and release it. The operating slide must be allowed to go forward by the force of its expanding spring. It must not be slowed in its forward movement by contact with the hand. If the operating slide is not com-

pletely released, the bolt may not lock. When this occurs, the carbine may not fire when the trigger is squeezed.

## TO FIRE THE CARBINE SEMI-AUTOMATICALLY

To fire the carbine semi-automatically, move the selector to the rear and squeeze the trigger for each shot.

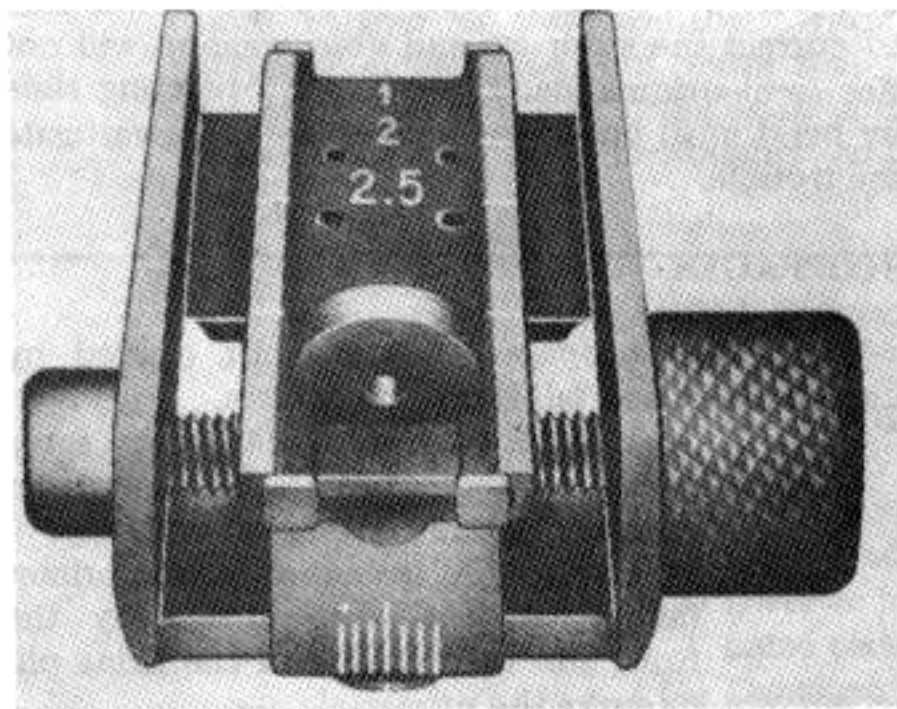

Figure 43a. The rear sight.

## TO FIRE THE CARBINE AUTOMATICALLY

*a.* When the carbine is fired automatically, accuracy is sacrificed for an increased volume of fire. Therefore, automatic fire should be used only when a large volume of fire is needed at very close ranges. You should be trained in the capabilities and limitations of this type of fire so that you can use it to the best advantage, keeping in mind such things as the availability of ammunition, the decrease in accuracy when firing automatically, and the demoralizing effect on the enemy.

*b.* To fire the carbine automatically, push the selector forward. When pressure is applied to the trigger, the carbine will fire as long as the trigger is held back and there is ammunition in the magazine. To cease firing, release the trigger.

*Caution:* Always release the trigger before shifting the selector to automatic. If the trigger is held back with the hammer cocked and the selector pushed forward to the automatic position, the carbine will fire.

## TO SET THE CARBINE AT SAFE

The loaded carbine must be kept locked until you are ready to shoot. To lock the carbine,

rotate the safety downward to its "ON" position. In this position, the trigger cannot be moved because the forward end of the trigger is blocked by the safety. When locked, the carbine may be loaded or unloaded by hand but it cannot be fired. To unlock the carbine, rotate the safety rearward to its "OFF" position.

## TO CLEAR THE CARBINE

To clear the carbine, unload it as explained in paragraph 30. Glance into the chamber and receiver to see that there are no cartridges in the weapon. Leave the bolt open.

## TO ADJUST THE REAR SIGHT

*a.* The rear sight of your carbine is adjustable (Fig. 43a), enabling you to engage targets accurately up to the maximum effective range. It has an elevation slide and a windage knob. The rear sight ramp has the numbers 1, 2, 2.5, and 3 corresponding to 100, 200, 250, and 300 yards of range. There is a corresponding indentation on the ramp for each of these ranges. The sight setting for 100 yards is also used for firing at 150 yards. The base of the rear sight has graduations for windage.

*b.* To raise the strike of the bullet on the target, increase the sight setting by moving the elevation slide toward you. To lower the strike of the bullet on the target, lower the sight setting by moving the elevation slide away from you. To move the strike of the bullet to the right, turn the windage knob away from you. This moves the aperture to the right and is called right windage. To move the strike of the bullet to the left, turn the windage on the rear sight. An easier way of saying all this is to move the rear sight in the direction that you want to move the strike of the bullet.

*c.* After setting the rear sight to any click of elevation or windage, move the adjustment knob or slide slightly in both directions to see that it is centered for that click.

## OPERATION CHECKS

With the carbine fully assembled and unloaded, and the safety rotated upward (firing position), the following operation checks may be made:

*a.* Pull the selector to the rear (semi-automatic position). With the trigger released, pull the

operating slide to the rear, cocking the hammer. Allow the operating slide to snap forward. The hammer should not fall.

b. With the trigger held to the rear, pull the operating slide to the rear, cocking the hammer. Allow the operating slide to snap forward. The hammer should not fall until the trigger is released and then squeezed.

c. With the trigger released, pull the operating slide to the rear, cocking the hammer. Allow the operating slide to snap forward. Push the selector to the forward (automatic) position. The hammer should not fall until the trigger is squeezed.

d. With the selector in the forward (automatic) position, pull the operating slide to the rear, hold the trigger back, and allow the bolt to close slowly. The hammer should not fall until the bolt is fully locked.

e. Test the safety with the selector in both positions. The hammer should not fall when the safety is moved to its "OFF" position.

## SAFETY PRECAUTIONS

Safety cannot be overemphasized. Some of the precautions to observe in handling the carbine follow. These precautions are not intended to replace other existing safety regulations.

a. A carbine with its bolt closed is never considered to be safe until it is properly inspected.

b. Do not playfully or carelessly point the carbine at anyone. Always consider the carbine loaded.

c. Do not leave any obstruction in the muzzle or bore.

d. Never push the selector forward to the automatic position while maintaining pressure on the trigger. If the trigger is held back with the hammer cocked and the selector pushed forward to the automatic position, the carbine will fire.

## SECTION IV. IMMEDIATE ACTION AND STOPPAGES

### GENERAL

If your carbine stops firing through no fault or intention of your own, then you have a stoppage. You must be able to clear such stoppages and continue firing. In combat your life may depend on your ability to reduce a stoppage quickly so you can continue to deliver accurate fire. Therefore, the first thing to do when you have a stoppage is to apply immediate action. This is the

unhesitating application of a probable remedy to clear a stoppage without investigating the cause.

### APPLYING IMMEDIATE ACTION

If your carbine fails to fire, pull the operating slide *all the way* to the rear with the right hand, palm up; release it, aim, and attempt to fire. This action will clear most stoppages. If this fails to correct the stoppage and your weapon will not fire semi-automatically, work the operating slide by hand until you have enough time to investigate the trouble.

### STOPPAGES

a. The stoppages that are not cleared by immediate action fall into three classes.

(1) *Failure to chamber* is caused by some condition that prevents the bolt from chambering the cartridge completely.

(2) *Failure to fire* is caused by the primer failing to fire when struck by the firing pin or a failure of the firing pin to strike the primer.

(3) *Failure to extract* is caused by an extremely dirty chamber or ammunition, or by a broken extractor or spring.

b. Table I gives the causes for these and other stoppages and tells you what action to take to correct them.

## SECTION V. CARE AND CLEANING

### GENERAL

Your carbine will be only as good as the care that you give it. Rust and dirt cause more wear than firing, and more carbines become unserviceable through lack of care and cleaning than for any other reason.

### CLEANING MATERIALS, LUBRICANTS, AND RUST PREVENTIVES

a. *Cleaning Materials.*

(1) *Rifle bore cleaner* is provided for cleaning the bore of your carbine after firing. It may be placed in the bore of your weapon after firing and left there for several hours until you can clean the weapon and apply a preservative oil. This material has rust-preventive



## M1 CARBINE

properties. After using rifle bore cleaner, dry the fore and apply a thin coat of preservative lubricating oil. Rifle bore cleaner freezes at temperatures below minus 20 degrees F. If thawed rifle bore cleaner is used, shake it well before using.

- (2) *Soap and water (warm or cold)* is used for cleaning the bore when the rifle bore cleaner is not available. Warm water alone is good, but warm soapy water is better. After using soap and water, dry the bore thoroughly and

apply a thin coat of light preservative lubricating oil.

- (3) *Volatile-mineral-spirits-paint thinner and dry-cleaning solvent* are non-corrosive solvents used for removing grease, oil, or light rust-preventive compounds from weapons. Do not use these solvents near an open flame, because they are highly inflammable. Smoking is prohibited where these solvents are being used. They will attack and discolor rubber. Apply with rag swabs to large parts and use

**Table I. Stoppages and Malfunctions**

MALFUNCTION	CAUSE	CORRECTION BY SOLDIER
Failure to chamber.	(1) Dirty or rough chamber. (2) Restricted gas port. (3) Dirty or improperly lubricated carbine. (4) Damaged magazine. (5) Ruptured cartridge case in chamber.	(1) Clean chamber. (2) Clean gas port. (3) Clean and lubricate carbine. (4) Replace magazine. (5) Remove ruptured cartridge case.
Failure to fire (hammer releases but carbine does not fire).	(1) Bolt not seated and locked. (2) Defective or broken firing pin. (3) Defective ammunition.	(1) Pull operating slide halfway to the rear and release it. Insure complete locking. (2) Replace bolt. (3) If practicable, secure new ammunition.
Failure to extract.	(1) Dirty or rough chamber. (2) Restricted gas port. (3) Dirty ammunition. (4) Broken extractor.	(1) Clean chamber. (2) Clean gas port. (3) Clean cartridge or, if practicable, secure new ammunition. (4) Replace bolt.
Fires in bursts of two or three rounds (rare). Pressure on trigger does not release hammer. Selector cannot be moved from automatic to semi-automatic setting.	(1) Sear broken or worn, or remains in open position. (1) Deformed hammer or trigger. (2) Broken trigger spring. (1) Selector spring incorrectly assembled in trigger housing group.	(1) Replace sear. (1) Replace defective part. (2) Replace trigger spring. (1) Place selector spring in proper position, loop toward trigger guard.
Disconnecter fails to function. Selector shifts to semi-automatic when firing automatic fire.	(1) Projecting lug on rear of disconnecter is broken. (1) Broken or weak selector spring.	(1) Replace disconnecter. (1) Replace selector spring.

as a bath for small parts. Clean all surfaces immediately and dry them thoroughly with clean rags. Then oil the parts. Since perspiration contains corrosive acids, avoid leaving finger marks.

- (4) *Decontaminating agents* are used under special conditions to remove chemical agents (Page 38).

## b. Lubricants.

- (1) *Medium preservative lubricating oil* is superior to special preservative lubricating oil for small arms exposed to salt-water atmosphere. It is heavier and possesses better preservative characteristics which make it useful for coating all parts of the weapon before landing operations. Use it in preference to special preservative lubricating oil when the carbine is to be exposed to salt water and at temperatures above +32 degrees F.

- (2) *Special preservative lubricating oil* is a thin oil used for lubricating at temperatures below +32 degrees F. and for providing temporary protection against corrosion. Use this oil for preserving the bore after the carbine has been fired and cleaned, as well as for lubricating all moving parts. When used on moving parts, it is necessary to maintain a thin film of oil to provide proper lubrication. Make frequent inspections to see that you have an adequate protective film of oil.

- (3) *Rifle grease* possesses good resistance to the action of water. Use it sparingly on those parts subject to heavy wear in wet climates or during amphibious operations. Figure 45 shows the parts where this grease should be applied. It is issued in a small plastic container.

- (4) *Engine oil, SAE 10* may be used when the oils mentioned above cannot be obtained. In cold weather, any oil as heavy as this causes sluggish operation and may prevent the carbine from working. This oil does not possess the rust-preventive properties of preservative lubricating oils. When engine oil is used, the weapons must be examined, cleaned, and reoiled frequently.

## c. Preservatives.

- (1) *Medium rust-preventive compound*

is issued for protecting the metal parts for long periods while the carbines are boxed and in storage. Warm it before application.

- (2) *Raw linseed oil* is a vegetable oil used to prevent the drying of the wooden parts and to preserve them; and it improves the appearance of the wood. Apply it with long strokes of the hand.

## CARE AND CLEANING WHEN NO FIRING IS DONE

a. *General.* This includes the care of the carbine to preserve its condition and appearance during the periods when no firing is done. Carbines in the hands of troops should be inspected daily to insure proper condition and cleanliness.

### b. Bore.

- (1) When you clean the bore, the magazine should be out and the bolt should be in the open position. The bolt normally can be held in the open position by the operating slide stop. Since the bolt can be released easily, you may place a piece of wood, or some similar object, between the hump of the operating slide and the rear of the hand guard to hold the bolt to the rear.

- (2) To clean the bore, use the M8 cleaning rod and several patches. If you use a rod longer than the M8, protect the face of the bolt against damage from the rod. Run a clean, dry patch forward and backward through the bore several times, making sure that the patch goes all the way through before reversing the direction. Repeat this several times, using a clean patch each time, until a patch comes out clean. Then, dip a patch in preservative lubricating oil, squeeze out the excess oil and run the patch through the bore several times.

*Caution:* Avoid careless use of the cleaning rod to prevent unnecessary wear at the muzzle; do not allow the cleaning rod to bear against the bore at the muzzle.

c. *Disconnecter Group.* See that the camming slot in the front end of the disconnecter is free from foreign matter and is not burred; the disconnecter plunger spring is not weak, rusted, or broken; the well for the disconnecter spring and

## M1 CARBINE

plunger assembly is clean; and the disconnecter plunger is not burred. Oil these parts lightly. The expanded end of the disconnecter spring should be seated in the disconnecter plunger. Check the rear of the disconnecter for burrs and wear.

*d. Disconnecter Lever Assembly.* See that the pivot on the crank end is not worn and is free from burrs, and that the straddle cuts on the trigger housing and selector pin are not worn. Such wear causes lost motion. Also check the disconnecter lever to make sure it is straight and free from burrs. The rear of the disconnecter lever assembly should not bind in the slotted groove or shoulder of the disconnecter. Oil the assembly lightly.

*e. Selector Group.* Clean the selector spring recess. Check the selector spring to see that it is not twisted and does not fit too loosely. If the selector spring is too loose, straighten it slightly.

*f. Trigger Housing.* See that the selector spring retention slot in the trigger housing group is free from dirt and seats the selector spring securely so that it will not turn.

*g. Operating Slide.* Oil the disconnecter lever cam on the operating slide. See that this surface is free from burrs.

*h. Magazine Catch.* See that the projection on the left side of the magazine catch is not burred.

*i. Stock.* See that the stock is neither so swollen nor warped that it will interfere with the action of the disconnecter, disconnecter lever, or selector.

*j. Screw Heads and Recesses.* Clean the small screw heads and all recesses with a small brush or stick. An old tooth brush or shaving brush is excellent for this purpose. Clean the metal parts with a dry cloth and wipe with an oil-dampened cloth to provide a protective finish. Wipe the stock and hand guards with a clean cloth, then rub in linseed oil.

*Caution:* After cleaning your carbine, do not use a muzzle plug or cover. They cause moisture to collect, and result in rust; and there is always the danger of forgetting to remove the plug before firing.

### CARE AND CLEANING BEFORE AND DURING FIRING ON THE RANGE

Before firing, take the following steps to make sure your carbine will function properly:

*a.* Field-strip it.

*b.* Clean the bore and chamber. Do not oil them.

*c.* Remove any carbon from the head of the piston nut.

*d.* Clean thoroughly all metal parts which do not come in contact with the ammunition and put a light coat of oil on them. Use special or medium preservative lubricating oil. Be sure that the following parts have a light coat of oil:

- (1) Locking lugs and the operating lug of the bolt and their recesses.
- (2) Bolt guide grooves in receiver.
- (3) Cocking cam on rear of bolt and firing pin tang recess.
- (4) Contact surface of barrel and operating slide.
- (5) Operating slide spring guide.
- (6) Operating slide handle grooves on side of the receiver.
- (7) Operating slide grooves in barrel.
- (8) Contacting surface of receiver and operating slide.
- (9) Cammed surfaces in the hump of the operating slide.
- (10) Piston.
- (11) Magazine catch and magazine catch plunger.
- (12) Operating slide stop.

*e.* Use rifle grease if the carbine is exposed to a great deal of rain or to spray from sea water, because the bolt may occasionally fail to open. This is caused by the friction resulting from the effect of the water and the fact that any ordinary lubricant is likely to be washed away from certain bearing surfaces. Under these conditions, it is essential that such surfaces be coated with rifle grease which resists the action of the water. Apply rifle grease to the parts shown in Figure 43b after wiping them clean and dry with a cloth. Rifle grease is not normally applied to other parts. After applying rifle grease, work the parts several times to spread the grease.

*f.* Inspect the bolt to determine whether cracks have developed. Give special attention to the right hand locking lug and the area next to the firing pin hole. Bolts having visible cracks should be replaced.

### CARE AND CLEANING AFTER FIRING

After you have fired, your main concern is to keep the carbine from becoming rusty. The deposit left after firing consists mainly of primer fouling, powder ashes, metal fouling, and carbon.

## M1 CARBINE

Although carbine ammunition has a noncorrosive primer, it will leave a deposit when dried. Since this deposit might collect moisture and promote rust, it must be removed. Rifle bore cleaner removes this deposit and the powder ashes. Metal fouling is not common. It is removed only by ordnance personnel.

*a. Clean the bore of your carbine thoroughly, preferably right after firing, and certainly no later than the evening of the day you fire it. The bore is cleaned in the same manner for the next 3 days.*

(1) Use the following equipment:

- (a) M8 cleaning rod.
- (b) Rifle bore cleaner.
- (c) Patches.
- (d) Preservative lubricating oil.
- (e) Waste wipes.

(2) Follow this procedure in cleaning the bore.

- (a) Wet patches (rifle bore cleaner or warm soapy water).
- (b) Brush.
- (c) More wet patches.
- (d) Dry patches.

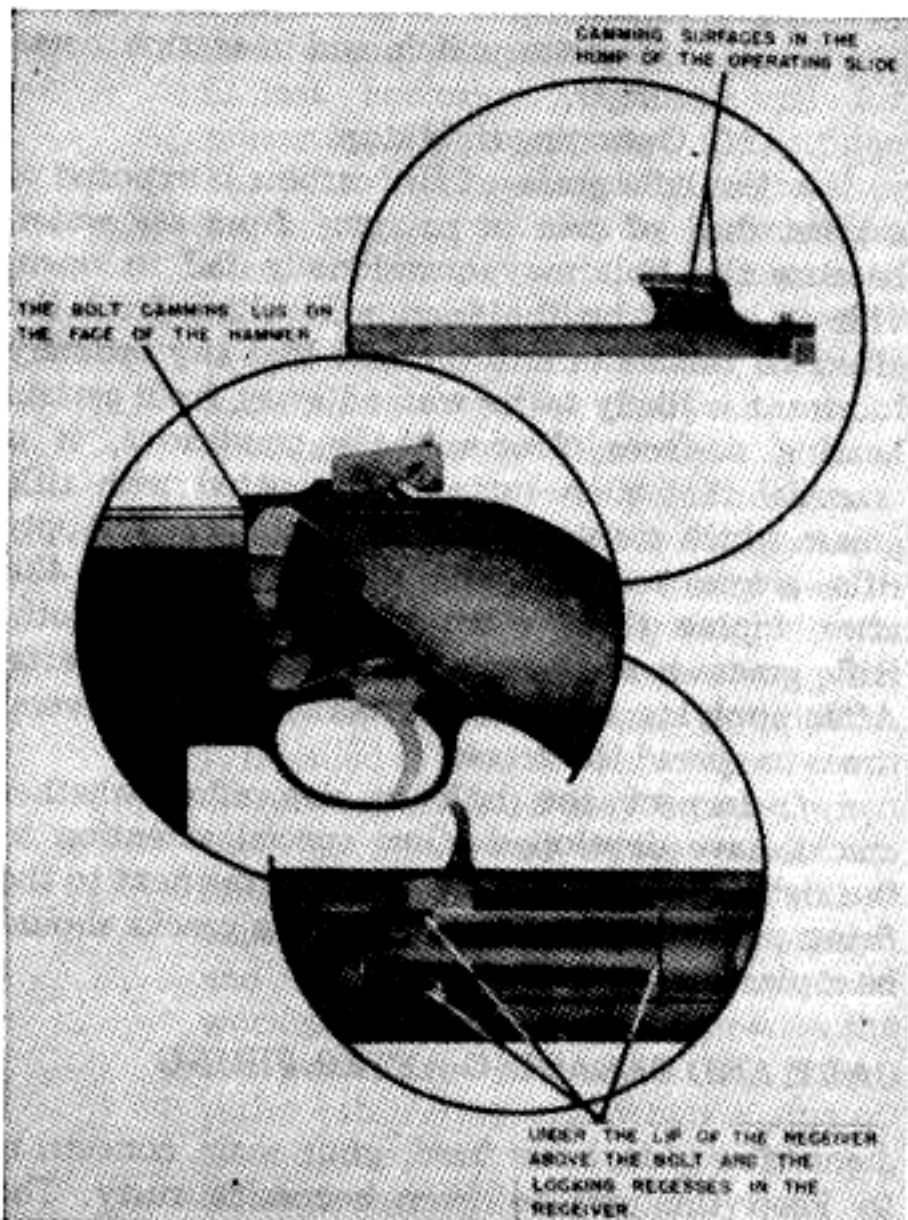

Figure 43b. Points on which to apply rifle grease.

(e) Inspection. (Repeat the above until a dry patch comes out clean and no evidence of fouling can be seen in the bore.)

(f) Oily patch.

*b. Additional cleaning of the chamber should not be necessary. The diameter of the chamber in the carbine is so nearly the same as that of the bore that the cleaning of the bore and chamber is accomplished simultaneously.*

*c. Clean the piston nut by removing the carbon. Your organizational artificer will supervise you when you remove the gas piston and piston nut of the gas cylinder group to clean them. Frequent removal of these parts causes excessive wear on the threads; therefore, these parts should be removed only when your carbine shows definite signs of insufficient gas. The lack of gas compression is indicated by failure to chamber or failure to extract a round. To remove the piston nut, clamp the barrel and receiver firmly in a vise with protected jaws and, using the gas piston nut removing tool, M5, unscrew the piston nut from the gas cylinder. When removing the piston nut be very careful not to burr or twist the prongs. To remove the piston, elevate the muzzle of the barrel and slide the piston nut out of the gas cylinder. If the piston will not slide out easily, tap the gas cylinder lightly with a wooden block. To remove the carbon from the piston and piston nut, use a cleaning patch saturated in rifle bore cleaner. Wipe off the excess with a dry patch and then apply a light coat of preservative lubricating oil. Be careful to align the threads when you replace the piston nut so that you will not burr them as you tighten the nut. If you cannot easily thread the piston nut back into place, give the carbine to your supply officer to send to the proper ordnance agency.*

*d. Clean the face of the bolt with a patch and rifle bore cleaner. After cleaning, dry and oil lightly.*

*e. Clean other metal parts and exterior surfaces with a dry cloth to remove dampness, dirt, and perspiration. Oil all metal parts with preservative lubricating oil. Oil the stock and hand guard with linseed oil. Rub it in well.*

### CARE AND CLEANING DURING COMBAT

*a. There is no basic difference between the care of a carbine during range firing and during combat except —*

- (1) The carbine may get much more severe treatment.
- (2) Conditions for maintenance may be much more difficult.
- (3) Issued materials for maintenance may be partially or completely lacking.

b. Because of the above conditions and because you have to keep your weapon in operating condition during combat, you must use your initiative, energy, and constant attention to overcome these difficulties.

c. To obtain the maximum efficiency from your carbine, observe the following points:

- (1) *Keep the bore and chamber clean.* Do not fire the carbine when dirt, mud, snow, or any other obstruction is in the bore. Such obstructions are extremely dangerous and may cause the barrel to swell or burst. Use a cleaning rod, if one is available, or the thong and brush which you should have. If these are not available, any slender rod or stiff wire can be used as a field expedient. Using any one of these, keep the bore and chamber clean and lightly oiled.
- (2) *Avoid excessive friction.* If the carbine shows signs of excessive friction due to lack of lubrication, apply oil to the parts that need it. If this friction is the result of dirt and there is no time to clean the carbine, use an extra amount of oil in the places needed. Friction is indicated if the empty cartridge cases are being ejected to the right rear or if the action of the bolt is sluggish. Apply oil at the first opportunity, as failure to chamber and eject will occur if the condition is not corrected.
- (3) *Use extra care under severe conditions.* If the carbine is to be exposed to severe conditions of rain or salt water, apply rifle grease. The points on which to apply this grease are shown in Figure 43b.

d. Keep a thin coating of preservative lubricating oil on all metal parts.

e. Remove the carbon from the head of the piston nut when necessary.

f. In emergencies when the prescribed lubricants are not available, use any clean light mineral oil such as engine oil.

## PREPARATION FOR STORAGE

Medium preservative lubricating oil is the most suitable oil for short term protection of the carbine mechanism. It is effective for storage over periods of 2 to 6 weeks, depending on climatic conditions. However, carbines in short term storage must be inspected every 4 or 5 days and the preservative films renewed if necessary. For longer periods of storage, carbines are protected with medium rust-preventive compound. Medium rust-preventive compound is a semi-solid material. It is efficient for preserving polished surfaces, the bore, and the chamber for a period of approximately 1 year, depending on climatic and storage conditions. The carbine must be cleaned and prepared for storage with particular care. The bore, all parts of the mechanism, and the exterior of the carbine should be thoroughly cleaned and then dried completely with rags. In damp climates, particular care must be taken to see that the rags are dry. After drying a metal part, the bare hands should not touch that part. All metal parts should then be coated with either medium preservative lubricating oil or medium rust-preventive compound, depending on the length of storage required. The rust-preventive compound can best be applied to the bore of the carbine by dipping the cleaning brush into the compound and then running it through the bore two or three times. The brush must be clean before it is used. Before placing the carbine in the packing chest, see that the bolt is in its forward position and that the hammer is released. Then, handling the carbine by the stock and hand guard only, place it in the packing chest whose wooden supports for the butt and muzzle have been painted with rust-preventive compound. *Under no circumstances should a carbine be wrapped in a cloth or other cover or be placed in storage with a plug in the bore.* Such covers collect moisture and make the weapon rust.

## CLEANING WEAPONS RECEIVED FROM STORAGE

Carbines are received from storage with a coating of preservative lubricating oil or of rust-preventive compound. Carbines received from ordnance storage will usually be coated with rust-preventive compound. Use volatile-mineral-spirits-paint thinner or dry-cleaning solvent to remove all traces of the compound or oil. Take particular care that all recesses in which springs or plungers operate are cleaned thoroughly. Failure to do this

## M1 CARBINE

may cause stoppages at normal temperatures and will certainly cause stoppages when the rust-preventive compound freezes during cold weather. After using the cleaning solvent, be sure it is completely removed from all parts by wiping with a dry cloth. Then apply a thin coat of preservative lubricating oil to all metal parts and use linseed oil on the wooden parts.

### CARE WHEN SUBJECT TO CHEMICAL ATTACK

a. If a chemical attack is expected or chemical contaminations are encountered, the following action should be taken: Apply oil to all outer metal surfaces of the carbine and accessories. Do not apply oil to ammunition. If the carbine is not to be used, cover it, the accessories, and the ammunition with protective coverings or disperse them under natural cover. Ammunition should be kept in its containers as long as possible. After a chemical attack, determine by means of detector paper (for liquid) or detector crayon (for vapors) whether or not the equipment is contaminated.

b. If uncontaminated, clean the equipment with a dry-cleaning solvent. Prepare it for use as required.

c. If contaminated, a complete suit of protective clothing (permeable or impermeable), including impermeable protective gloves, and a gas mask must be worn during decontamination.

- (1) Equipment contaminated with chemicals other than the blister agents or G-series agents can be decontaminated by airing. For faster decontamination of this equipment and to protect against corrosion, clean the carbine and its equipment with rifle bore cleaner, denatured alcohol, or soap and water.
- (2) Equipment contaminated by blister agents will be decontaminated as follows:
  - (a) Remove dirt, dust, grease, and oil by wiping with rags.
  - (b) Expose all surfaces to air.
  - (c) Decontaminate all metal surfaces except the bore with agent, decontaminating, noncorrosive (DANC) (FM 21-40). Hot water and soap, or repeated applications with gasoline soaked swabs are also effective.
  - (d) Protective ointment, M5, carried in the gas mask carrier, can be used

for emergency decontamination (FM 21-40).

- (e) Test with detector paper or detector kit to see if decontamination is complete.
  - (f) After decontamination and tests are complete, clean, dry, oil, and prepare the carbine and its equipment for use as required.
  - (g) Burn, or preferably bury, all rags or wiping materials used during decontamination. Caution should be taken to protect men against vapors created by burning.
- (3) In general, these same actions are applicable to equipment contaminated by biological or radiological attack. If contamination is too great, it may be necessary to discard the equipment. Detailed information on decontamination is contained in FM 21-40 and TM 3-220.

### CARE AND CLEANING UNDER UNUSUAL CLIMATIC CONDITIONS

a. *In Cold Climates.* In temperatures below freezing, the moving parts of your carbine must be kept absolutely free from moisture. Also, excess oil on the working parts will solidify to such an extent as to cause sluggish operating or complete failure.

- (1) The carbine should be disassembled and completely cleaned with volatile-mineral-spirits-paint thinner or dry-cleaning solvent before use in temperatures below 32 degrees F. The working surfaces of parts which show signs of wear may be lubricated by rubbing with a cloth which has been wetted in special preservative lubricating oil; other parts are left dry. At temperatures above 32 degrees F., all metal surfaces of the carbine may be oiled thinly, after cleaning, by wiping with a lightly oiled cloth using the medium preservative lubricating oil.
- (2) When brought indoors, the carbine should first be allowed to come to room temperature. Moisture will condense on the cold surfaces. Then disassemble the carbine and wipe it completely dry. Oil with the special preservative lubricating oil. This condensation may be avoided by providing

a cold place in which to keep the carbine when not in use. For example, a separate cold room with carbine racks may be used, or, when in the field, racks under proper cover may be improvised. If the carbine has been fired, it should be cleaned and oiled. When the carbine reaches room temperature it should be cleaned and oiled again.

*b. Hot, Humid Climates.* In tropical climates where temperature and humidity are high, or where salt air is present, and during rainy seasons, your carbine should be inspected thoroughly every day. It should be kept lightly oiled when not in use. The carbine should be field stripped at regular intervals and if necessary, should be disassembled enough to permit the drying and oiling of all parts. Care should be taken to see that unexposed parts and surfaces are kept clean and oiled. Medium preservative lubricating oil should be used. Wood parts should be inspected to see that swelling caused by moisture does not bind working parts. If swelling has occurred, shave off the wood *only enough* to relieve binding. A light coat of raw linseed oil applied at intervals and rubbed in with the heel of the hand will help to keep moisture out. Allow the oil to soak in for a few hours and then wipe and polish the wood with a dry clean rag. Care should be taken that linseed oil does not get on the working parts, because linseed oil thickens when dry. Stock and hand guards should be dismounted while this oil is being applied.

*c. Hot, Dry Climates.* In hot, dry climates where sand and dust are likely to get into the mechanism and bore, the carbine should be wiped clean daily or oftener. Groups should be separated and disassembled for thorough cleaning. When the carbine is being used under sandy conditions, all lubricants should be wiped from the weapon. This will prevent sand from sticking to the lubricant and forming an abrasion which will ruin the mechanism. Upon leaving sandy terrain, the carbine should be cleaned and relubricated. In such climates, the wood parts are likely to dry out and shrink. A light application of raw linseed oil will help to keep the wood in condition. Since perspiration from the hands contains acid and causes rust, it should be wiped from all metal parts. During sand or dust storms, the receiver and muzzle should be kept covered if possible.

## SECTION VI. SPARE PARTS, APPENDAGES, AND ACCESSORIES

### SPARE PARTS

Some parts of your carbine may in time become unserviceable through breakage or wear resulting from continuous use. Extra parts are provided with the carbine to replace those parts most likely to fail. These parts normally will be kept with the organizational property. They should be kept cleaned and lightly oiled to prevent rust. Sets of spare parts should be kept complete at all times. Whenever a spare part is used to replace a defective part in the carbine, the defective part should be repaired or replaced. Parts that are carried complete should be correctly assembled and ready for immediate use with the carbine. The allowances of spare parts are prescribed in Ord 7 SNL B-28. Except for replacements with the spare parts mentioned above, repairs or alterations to the carbine are made only by ordnance personnel.

### APPENDAGE

The bayonet knife is a blade sharpened along the entire lower edge and partially along the upper edge. It is made to fit securely into the scabbard or onto the forward end of the carbine. A hand grip on its base makes it a suitable hand weapon or utility tool.

### ACCESSORIES

Accessories include the tools required to assemble and clean your carbine, and the gun sling, spare parts containers, covers, arm lockers, and similar articles. They should be used for no other purpose than that for which they are intended. When not in use, they should be stored in the places provided for them. Detailed descriptions or methods for the use of all such accessories are not outlined in this manual. However, some of the most common accessories are described below.

*a. The brush and thong* are used for cleaning the bore of the carbine when the cleaning rod is not available.

*b. The cleaning rod M8* is of such length as to prevent damage to the follower or the face of the bolt. The rod has a handle at one end and is threaded at the other end to receive the patch or brush sections. The patch section is slotted to permit the insertion of a cleaning patch; the brush section is used to clean the bore of the carbine

## M1 CARBINE

after firing. The cleaning rod is provided with a web case for carrying purposes.

c. *The oiler*, complete with cap and rod, contains oil for lubricating the carbine when the normal supply of oil is not available. The oiler also serves at the lower sling swivel.

d. *The sling M1* is placed on your carbine as shown in Figures 1 to 3 inclusive. The carbine sling is used for carrying purposes only.

### SECTION VII. AMMUNITION

#### GENERAL

The ammunition that you may use in the carbine is described in this section. Your carbine can fire several types of ammunition. You are responsible for being able to recognize these types, for knowing which is best to use for certain targets, and for taking proper care of the ammunition.

a. In most type of small-arms ammunition, a cartridge consists of a cartridge case, primer, propelling charge, and the bullet.

b. The term *bullet* refers only to a small arms projectile. The term *ball* was originally used to describe the ball shaped bullet of very early small arms ammunition. The term *ball ammunition* now refers to a cartridge having a bullet which has a metallic jacket filled only with lead.

#### CLASSIFICATION

Based on use, the principal classifications of the several types of ammunition used with your carbine are —

a. *Ball, M1* — for use in marksmanship training and combat.

b. *Tracer, M16 and M27* — observation of fire, incendiary, and signaling purposes.

c. *Dummy, M13* — for training (cartridges are inert).

#### LOT NUMBER

When ammunition is manufactured, it is given an ammunition lot number. This lot number is marked on all packing containers. It is also on the identification card inclosed in each packing box. The lot number is required for all purposes of record, such as grading and use, and reports on the condition, functioning, and accidents in which the ammunition might be involved. It is impracticable to mark the ammunition lot number on each individual cartridge. Every effort should be made to maintain the ammunition lot number or the

repacked lot number with the cartridges after they are removed from their original packing. Cartridges which have been removed from their original packing for which the ammunition lot number has been lost are automatically placed in grade 3; these are not to be fired.

#### IDENTIFICATION

a. *Markings*. The contents of original boxes may be readily identified by the markings on the box. Similar markings on the cardboard carton label identify the contents of each carton. The markings which appear on the box and carton give complete information necessary for identification, shipping, care, handling, and use.

b. *Identification of Ammunition Types*. In general, all types of cartridges of one caliber look alike in shape and size, but they may be identified by certain physical characteristics. The ammunition authorized for use with the carbine and the way to identify each type after it has been removed from the original container follows:

Types of cartridge	Identification
Ball	All models of caliber .30 ball ammunition have bullets coated with gilding metal, a copper alloy, which prevents fouling in the bore of the rifle. Ball ammunition has no identifying color on the tip of the bullet.
Tracer	Tip of the bullet is painted red or orange.
Dummy	The cartridge is inert and has three holes in the case.

#### CARE, HANDLING, AND PRESERVATION

Most men have at one time or another fired a rifle or a pistol, or perhaps both types of weapons. If you have, it means you have also handled ammunition for these weapons. You know that the ammunition was not dangerous to handle. This, of course, does not mean that you handled the ammunition carelessly. The ammunition used in your carbine is not dangerous to handle, but there is a *correct* way to handle it.

a. Try to prevent ammunition boxes from becoming broken or damaged. All broken ammunition boxes must be repaired immediately. All original markings must be transferred to the new parts of the box. The metal liner should be



## M1 CARBINE

air tested and sealed if equipment for this work is available.

b. Open wooden ammunition boxes carefully. They are used as long as they are serviceable.

c. Do not open ammunition boxes until the ammunition is to be used. Ammunition removed from the airtight container, particularly in damp climates, is likely to corrode. This ammunition is unserviceable.

d. Protect ammunition from mud, sand, and water. If it gets wet or dirty, wipe it off at once with a clean, dry cloth. A light corrosion should be wiped off as soon as it is discovered. Cartridges with a heavy coat of corrosion must be turned in.

e. During marksmanship and combat training, do not fire any caliber .30 carbine ammunition until it has been identified by an ammunition lot number and grade.

f. Do not expose ammunition to the direct rays of the sun. If the powder is heated, excessive pressure may be developed when the weapon is fired. This condition will affect ammunition performance.

g. Do not oil or grease ammunition. The dust and other abrasives that collect on greasy ammunition are harmful to the operating parts of the carbine.

h. Do not attempt to fire cartridges that have bad dents, scratches, or loose bullets, or those that are rusted. If you think a cartridge is defective, return it. Do not throw away or attempt to destroy defective ammunition.

i. Be especially careful not to strike the primer of a cartridge since this may ignite the cartridge.

### STORAGE

a. Small-arms ammunition is not an explosive hazard. Under poor storage conditions, however, it may become a fire hazard.

b. Small-arms ammunition of all classes should be stored away from radiators, hot water pipes, and other sources of heat.

c. Whenever practicable, small-arms ammunition should be stored under cover. If it is necessary to leave ammunition in the open, it should be raised at least six inches from the ground and covered with a double thickness of tarpaulin. The tarpaulin should be placed so that it gives maximum protection and allows free circulation of air. Suitable trenches must be dug to prevent water from flowing under the ammunition pile.

### BALLISTIC DATA

The approximate maximum range and average muzzle velocity of the different types of caliber .30 carbine ammunition authorized for use in the carbine are shown below.

Cartridge	Max. range (yards)	Average muzzle velocities (fps)
Ball, M1	2,200	1,970
Tracer, M16	1,680	1,910
Tracer, M27	1,600	1,910

### PRECAUTIONS IN FIRING AMMUNITION

The general precautions concerning the firing and handling of ammunition in the field as prescribed in SR 385-310-1 and in TM 9-1900 will be observed. Precautions particularly applicable to small-arms ammunition are given in the following paragraphs.

a. No small-arms ammunition will be fired until it has been positively identified by ammunition lot number and grade.

b. Small-arms ammunition graded and marked *for training use only* will not be fired over the heads of troops under any circumstances.

c. Before firing, be sure that the bore of your weapon is free from any foreign matter such as cleaning patches, mud, sand, snow, and the like. Any obstruction in the bore will damage the weapon and may injure you.

d. When a bullet lodges in the bore of a carbine, you should remove it by applying pressure from the muzzle end of the weapon. To attempt to shoot the bullet out with another cartridge is dangerous and is prohibited.

### HANGFIRES

When a hangfire (a perceptible delay between the blow of the hammer and the firing of the round) occurs, further use of ammunition from that lot should be suspended and a report made to the post ordnance officer, giving the lot number involved. The lot affected will be withdrawn and replaced by serviceable ammunition.



## IV. Inspection

### SECTION I. GENERAL

#### SCOPE

This chapter provides specific instructions for the technical inspection by ordnance maintenance personnel of materiel either in the hands of troops or when received for repair in ordnance shops. It also briefly describes the in-process inspection of materiel during repair or rebuild and the final inspection after repair or rebuild has been completed. Trouble shooting information is incorporated wherever applicable as a normal phase of inspection.

#### PURPOSES OF INSPECTIONS

Inspections are made for the purposes of (1) determination of the condition of an item as to serviceability, (2) determination of incipient failure, (3) the assurance of proper application of maintenance policies at prescribed levels, and (4) the ability of a unit to accomplish its maintenance and supply missions.

#### CATEGORIES OF TECHNICAL INSPECTION

In general, five categories of inspection are performed by ordnance maintenance personnel.

*a. Over-all Inspection.* This is a periodic over-all inspection performed by a contact party on materiel in the hands of troops and an inspection performed by maintenance company personnel when materiel is evacuated to the ordnance company. The inspection of materiel evacuated is more thorough and includes check and repair of minor

points that would not be required in the inspection performed by a contact party.

*b. Pre-embarkation Inspection.* This inspection is conducted on materiel in alerted units scheduled for oversea duty to insure that such materiel will not become unserviceable or worn out in a relatively short time. It prescribes a higher percentage of remaining usable life in serviceable materiel to meet a specific need beyond minimum serviceability.

*c. In-process Inspections.* These are inspections performed in the process of repairing (field maintenance) or rebuilding (depot maintenance) the materiel as prescribed in Chapter 4. This is to insure that all parts conform to the prescribed standards, that the workmanship is in accordance with approved methods and procedures, and that deficiencies are disclosed by the preliminary inspection are found and corrected. Detailed instructions are contained in Chapter 4.

*d. Final Inspection.* This is an acceptance inspection performed by a final inspector, after repair or rebuild has been completed, to insure that the materiel is acceptable for return to user or for return to stock according to the standards established. Detailed instructions are contained in Chapter 5.

*e. Spot Check Inspection.* This is a periodic over-all inspection performed on only a percentage of the materiel in each unit to determine the adequacy and effectiveness of organizational and field maintenance.

SECTION II. TECHNICAL INSPECTION

GENERAL

*Warning:* Before starting a technical inspection, be sure to clear the weapon. Do not touch the trigger until the weapon has been cleared. Inspect the chamber to insure that it is empty and check to see that no ammunition is in position to be introduced. Avoid having live ammunition in the vicinity of the work.

*a. Preparatory Procedures.*

- (1) Check to see that the weapon has been cleaned of all corrosion-preventive compound, grease, excessive oil, dirt, or foreign matter which might interfere with proper functioning or obscure the true condition of the parts.
- (2) Make an over-all inspection of the weapon for general appearance, condition, operating, and manual functioning. Use dummy cartridges.

*b. Inspection Guide.* Table II is provided as a check list to be used as a guide for the inspection of weapons in the hands of troops. The over-all inspection column lists the standards denoting minimum serviceability and next column lists the standards for pre-embarkation inspection.

Note. The additional columns are provided for comparative information only to show the standards which are desired when the weapon is repaired or rebuilt in ordnance field or depot shops.

INSPECTION OF MATERIEL IN THE HANDS OF TROOPS

*a. General.* Refer to TM 9-1100 for responsibilities and fundamental duties of inspecting personnel, the necessary notice and preparations to be made, forms to be used, and general procedures and methods to be followed by inspectors. Materiel to be inspected includes organizational spare parts and equipment and the stocks of cleaning and preserving materials. In the course of this technical inspection the inspector will accomplish the following:

- (1) Determine serviceability, i.e., the degree of serviceability, completeness, and readiness for immediate use, with special reference to safe and proper functioning of the materiel. If the materiel is found serviceable, it will be continued in service. In the event it is

found unserviceable or incipient failures or disclosed, the deficiencies will be corrected on the spot or advice given as to corrective measures when applicable, or if necessary, the materiel will be tagged for delivery to and repair by ordnance maintenance personnel.

- (2) Check for causes of mechanical and functional difficulties that troops may be experiencing and for apparent results of lack of knowledge, misinformation, neglect, improper handling and storage, security, or preservation.
- (3) Check on application of all authorized modifications to see that no unauthorized alterations have been made or that no work beyond the authorized scope of the unit is being attempted. The following modification work orders are considered mandatory as of this printing; however, also check the index in SR 310-20-4 and the current modification work order files for any additional modification work orders promulgated subsequent to this printing.

MWO	TITLE
MWO ORD B28-W3	Replacement of leaf type rear sight with adjustable rear sight.
MWO ORD B28-W4	Replacement of magazine catch and plunger to provide increased holding.
MWO ORD B28-W5	Replacement of front band to provide for attachment of bayonet.
MWO ORD B28-W6	Replacement of sliding type safety with rotary type.
MWO ORD B28-W7	Replacement of disconnecter plunger assembly to prevent its loss.

- (4) Instruct the using personnel in proper preventive maintenance procedures if and where found inadequate.
- (5) Check on completeness of the organizational maintenance allowances and procedures for obtaining replenishments.

Table II. Inspection Guide for Cal. .30 Carbines M1, M1A1, M2, and M3

Point To Be Inspected	Overall Inspection	Pre-embarkation Inspection	Final Inspection, Field Maintenance	Final Inspection, Depot Maintenance
<p><b>BORE AND CHAMBER</b></p> <p><b>FINISH</b></p> <p><b>FIRING PIN PROTRUSION. FRONT BAND</b></p> <p><b>FRONT SIGHT</b></p> <p><b>HAND GUARDS</b></p>	<p>Pits in chamber are allowable if they are not large enough to cause extraction difficulties. Pits in the bore as wide as a land or groove and three-eighths inch, or less, in length are allowable. Tool marks or scratches are acceptable regardless of length. Tool marks will appear as lines running laterally in the grooves or may run spirally across top of lands. Definitely ringed bores or bores ringed sufficiently to bulge the outside surface of the barrel must be rejected. However, faint rings or shadowy depressions are acceptable. Lands must be sharp.</p> <p>Some glare permissible. No check.</p> <p>Apply MWO ORD B28-W5 if not accomplished.</p> <p>Securely assembled with no burrs or malformations.</p> <p>Not damaged so as to affect strength. Some looseness when assembled is acceptable. Liner must be tight.</p>	<p>Intact enough to prevent glare. No check.</p> <p>Apply MWO ORD B28-W5 if not accomplished.</p> <p>Securely assembled with no burrs or malformations.</p> <p>Checks and cracks not affecting strength are acceptable. Some looseness when assembled is acceptable. Liner must be tight.</p>	<p>Intact enough to prevent glare. Inspect visually.</p> <p>Apply MWO ORD B28-W5 if not accomplished.</p> <p>Securely assembled with no burrs or malformations.</p> <p>Checks and cracks not affecting strength are acceptable. Some looseness when assembled is acceptable. Liner must be tight.</p>	<p>Approximate new finish. Min. 0.048. Max. 0.065.</p> <p>Apply MWO ORD B28-W5 if not accomplished.</p> <p>Securely assembled with no burrs or malformations.</p> <p>Seasoned checks and cracks which have been reinforced by pins are acceptable. Some looseness when assembled is acceptable. Liner must be tight.</p>

M1 CARBINE

Table II continued.

Point To Be Inspected	Overall Inspection	Pre-embarkation Inspection	Final Inspection, Field Maintenance	Final Inspection, Depot Maintenance
<p align="center"><b>HEADSPACE</b></p>	<p>Bolt must not close on headspace gage 7319943 (headspace lgh. 1.302) but must close without forcing on headspace gage 7319934 (headspace lgh. 1.290).</p>	<p>Bolt must not close on headspace gage 7319943 (headspace lgh. 1.302) but must close without forcing on headspace gage 7319934 (headspace lgh. 1.290).</p>	<p>Min. 1.290 Max. 1.302 Use gage 7319934 or 7319943.</p>	<p align="center"><b>Rebarreled</b></p> <p>Min. 1.290 Max. 1.295 Use gage 7319934 or 7319936. With field test bolt 7329936. With field test bolt 7319932.</p> <p align="center"><b>Not Rebarreled</b></p> <p>Min. 1.290 Max. 1.298 Use gage 7319934 or 7319938.</p>

Table II continued.

Point To Be Inspected	Overall Inspection	Pre-embarkation Inspection	Final Inspection, Field Maint.	Final Inspection, Depot Maint.
<p><b>MAGAZINE CATCH</b></p>	<p>Magazine catch is to engage magazine with sufficient force to prevent removal of magazine without releasing catch. Apply MWO ORD B28-W4 if not accomplished.</p>	<p>Magazine catch is to engage magazine with sufficient force to prevent removal of magazine without releasing catch. Apply MWO ORD B28-W4 if not accomplished.</p>	<p>Magazine catch is to engage magazine with sufficient force to prevent removal of magazine without releasing catch. Apply MWO ORD B28-W4 if not accomplished. Inspect each assembly to assure that the magazine catch can be pushed rearward in the trigger housing and that the safety plunger spring is strong enough to return it firmly to the forward position. The forward pressure on the magazine catch must not prevent proper sidewise travel of catch.</p>	<p><b>Not Rebarreled</b></p> <p>Magazine catch is to engage magazine with sufficient force to prevent removal of magazine without releasing catch. Apply MWO ORD B28-W4 if not accomplished. Inspect each assembly to assure that the magazine catch can be pushed rearward in the trigger housing and that the safety plunger spring is strong enough to return it firmly to the forward position. The forward pressure on the magazine catch must not prevent proper sidewise travel of catch.</p>

Table II continued.

Point To Be Inspected	Overall Inspection	Pre-embarkation Inspection	Final Inspection Field Maint.	Final Inspection, Depot Maint.
<p>REAR SIGHT</p> <p>SAFETY</p> <p>STOCK</p> <p>TRIGGER PULL</p>	<p>Elevation and windage slides to function smoothly throughout range. Graduations to be legible. Apply MWO ORD B28-W3 if not accomplished.</p> <p>Apply MWO ORD B28-W6 if not accomplished. Rotate safety to see that it functions properly.</p> <p>Not damaged to extent that it will affect strength.</p> <p>Min. 4½ lb. Max. 7 lb.</p>	<p>Elevation and windage slides to function smoothly throughout range. Graduations to be legible. Apply MWO ORD B28-W3 if not accomplished.</p> <p>Apply MWO ORD B28-W6 if not accomplished. Rotate safety to see that it functions properly.</p> <p>Seasoned checks, small dents and insignificant cracks are acceptable.</p> <p>Min. 4½ lb. Max. 7 lb.</p>	<p>Elevation and windage slides to function smoothly throughout range. Graduations to be legible. Apply MWO ORD B28-W3 if not accomplished.</p> <p>Apply MWO ORD B28-W6 if not accomplished. Rotate safety to see that it functions properly.</p> <p>Seasoned checks, small dents and insignificant cracks are acceptable.</p> <p>Min. 4½ lb. Max. 7 lb.</p>	<p>Elevation and windage slides to function smoothly throughout range. Graduations to be legible. If necessary, refill windage markings with white graduation filler. Apply MWO ORD B28-W3 if not accomplished.</p> <p>Apply MWO ORD B28-W6 if not accomplished. Rotate safety to see that it functions properly.</p> <p>Approximate new stock. If necessary, sand and refinish. Patchwork not affecting strength is acceptable. Repair screws and wood dough acceptable.</p> <p>Min. 4½ lb. Max. 7 lb.</p>

## M1 CARBINE

- (6) Check conditions of storage of general supplies and ammunition.
- (7) Initiate a thorough report on materiel on "deadline," with reasons therefor, for further appropriate action.
- (8) The inspector should report to the responsible officer any carelessness, negligence, unauthorized modifications, or tampering. This report should be accompanied by recommendations for correcting the unsatisfactory conditions.

### *b. Inspection for Appearance and General Condition.*

- (1) Inspect barrel and receiver group for looseness in stock, and hand guard for excessive looseness on stock. Hand guard may have slight movement backward and forward. However, there should be no possibility of its becoming disengaged from the front band or skirt on the receiver. Tight hand guards are likely to push band off when recoil is heavy, as when grenade launcher is used.
- (2) Inspect front band for looseness and locking on carbine and inspect sling swivel for looseness on band. Band should be held firmly in place by shoulder of locking spring.
- (3) Inspect stock and hand guard for cracks; deep scars; and bare, rough wood surface: check grip (M1A1) for looseness in stock and for cracks.
- (4) Inspect front and rear sights for looseness.
- (5) Inspect oiler for retention in stock and for new type neoprene gasket. Inspect sling for wear and security on carbine.
- (6) Inspect metal parts for rust, corrosion, scoring, and cracks.
- (7) Inspect magazine for retention in trigger housing, ease of withdrawal, undue looseness, dents, rust, and movement of follower.
- (8) Inspect sling eyelet for looseness on lower hinger assembly (M1A1), and hinge for looseness on stock grip.
- (9) Inspect stock extension (M1A1) for hinge action, and positive locking when extended and folded, and butt plate for rotation and spring action on bars.
- (10) Inspect cheek rest plate and retaining plate (M1A1) for looseness on bars,

and cheek rest plate cover for wrinkles, scoring, and dried out leather.

- (11) Inspect barrel.
- (12) Check to see that serial numbers on the receivers of M1 and M1A1 carbines (Fig. 87) have not been obscured by the installation of the adjustable rear sight 7160060 (stamped type).

*c. Functional and Operational Inspection.*  
The following are in addition to inspections covered on page 31.

- (1) *Complete locking of bolt and forward movement of operating slide.* The slide should continue to move forward about five-sixteenth of an inch after the bolt is fully locked. The same free movement should take place at the start of the rearward movement of the slide, before rotation of the bolt begins.
- (2) *Chambering of cartridge.* The bolt should chamber the cartridge smoothly when released. If bullet ramp on receiver or barrel is rough, or if magazine catch does not retain magazine allowing it to tip forward, the bullet may bind on ramp or be deflected upward during chambering and strike the top of the barrel causing a stoppage.
- (3) *Engagement of sear when trigger is not released.* On carbines M1 and M1A1 and on carbines M2 and M3 in semi-automatic position, the sear should engage and hold the hammer when the trigger is held back and the slide operated rapidly. This can be tested for by the following procedure:
  - (a) Grasp carbine by grip of stock with left hand.
  - (b) With index finger of left hand, pull trigger all the way to the rear and hold it in that position.
  - (c) Grasp operating slide handle with the right hand and move bolt back and forth rapidly five or six times, allowing the operating slide to come to rest in its forward position.
  - (d) Release trigger completely and then pull it again. If the hammer does not fall, it has been jarred out of engagement with the sear and followed the bolt forward. If this is the case, the carbine may fire in an uncontrolled manner and the firing



## M1 CARBINE

mechanism must be inspected for worn or faulty parts.

- (4) *Uncontrolled fire.* It has been found that at times individual carbines M1 and M1A1 fire in an uncontrolled manner. The term "uncontrolled" means that more than one cartridge is chambered and fired when the trigger is actuated once. Since the carbines M1 and M1A1 are both semi-automatic weapons, only one round should be fired whether the trigger is held or released. This tendency can often be determined during firing by the following procedure:
- (a) Hold trigger in rearmost position.
  - (b) Manually retract the operating slide and allow it to return to battery.
  - (c) Release trigger very slowly. If carbine tends to fire in an uncontrolled manner, the hammer will often fall when the sear is heard to snap. The shock of counterrecoil will sometimes jar hammer from sear and uncontrolled fire results.
- (5) *Safety.* The safety should rotate without undue interference. It should block trigger when turned so that the tang is vertical and release trigger when tang is pointing to the rear. It should be positively retained in either position.
- (6) *Operating slide stop.* The operating slide stop is for the purpose of "hanging" the slide and bolt in the retracted position. Test functioning of stop by retracting bolt with operating slide, spring, and guide assembled, and pressing stop into retaining notch in receiver. When "hung" slide is slightly retracted, the stop should be cammed out of retaining notch in receiver and lie flush with (or above) lower face of slide and be held in this position by the friction spring. If stop spring becomes broken, stop may catch in retaining notch when slide reciprocates. If nose of stop or edge of retaining notch becomes worn, or friction spring becomes weak or broken, stop is likely to slip and fail to hang bolt. If there is insufficient friction on stop, it may jar into the notch and "hang" the bolt when the carbine functions. If such is

the case, replace stop, spring, or operating slide.

*d. Magazine.* Test magazine for retention in carbine. Inspect follower for smooth movement in tube under force of spring by depressing follower and allowing it to rise. If follower does not depress and rise smoothly to the top of tube under spring action, look for burrs, rust, and corrosion in tube, reversed follower, deformed, or burred tube or follower, and weak, broken or reversed spring. Apply pressure evenly on the follower when depressing in order not to "cock" or rotate it in the tube.

*e. Rear Sight Assembly.* See page 75 for inspection of the rear sight assembly.

*f. Barrel and Receiver Group.* See page 80 for inspection of the barrel and receiver group.

*g. Head Space Gaging.*

- (1) The head space of a carbine is the distance between the shoulder of the chamber and the face of the bolt when the bolt is in locked position. If head space is insufficient, the bolt will not fully lock behind the cartridge without being forced. If head space is excessive, the cartridge will have too much play in the chamber when the bolt is locked behind it. Either condition is unsafe. As component parts of the carbine are manufactured to close tolerances and head space is carefully checked at manufacture, any variation causing excessive head space to develop is due to wear.
- (2) Excessive head space, due to wear, may be caused by worn faces of bolt, worn locking lugs on bolt, or worn locking shoulders in the receiver.
- (3) Before testing for head space, clean bore, chamber of barrel, and operating parts thoroughly, wipe dry, and inspect for metal fouling or foreign matter. Operate the mechanism a few times to see that the bolt closes and locks smoothly on an empty chamber. Disengage the bolt from the operating slide.
- (4) See page 82 for procedure in checking head space.

*h. Trigger Pull.*

- (1) *General.* The testing of trigger pull of carbines requires the availability of hooks and weights, which combine to 4½ and 7 pounds. Test trigger pull for

## M1 CARBINE

smoothness and for pressure exerted. Trigger pull should be clean, without creep, smooth in action; and the force exerted to release hammer should be more than 4½ pounds and less than 7 pounds. If pull is rough, or not within specified limits, or creep is present, it indicates that there is wear or burrs on sear nose, hammer notch, or top of trigger lip, or interference between trigger and housing.

Note. The word "creep" is interpreted to mean any perceptible movement in the trigger pull between the time the slack is taken up and the hammer is released, with pressure applied to the trigger at a uniform rate of increase over a period of 10 seconds or more.

- (2) *Testing trigger pull* (Fig. 43c). Note that safety is disengaged (its tang is point to rear) and that carbine is cocked. Have the weights resting on the floor or ground and insert the hook of trigger weight wire through the trigger housing guard bow to bear on the trigger so that pressure is applied one-quarter inch from lower end or tip of trigger. With the barrel of the carbine held vertically, raise the weight from the floor as gently as possible. If 4½-pound weight pulls the trigger to release the hammer, or the 7-pound weight fails to pull the trigger to release the hammer, correction is required. The only correction allowed in field repair is the selective assembly of hammer, hammer spring, sear, or trigger or all four until the required pull is obtained. Take care during the test to see that the wire contacts the trigger only and does not rub against the trigger housing or stock, and that wire and axis of bore are perpendicular to the floor.

Note. Each time weights are applied to the trigger, cock the weapon again, otherwise sear may be partially disengaged from hammer. This will result in a false reading next time weights are applied.

### *i. Inspection of Functions Peculiar to Carbines M2 and M3.*

With carbine fully assembled, unloaded, and safety turned to fire position, test functioning as follows:

- (1) Pull selector fully to rear to place mechanism in the semi-automatic position. Then, with trigger released, fully retract bolt to cock the hammer and allow bolt to spring forward. Hammer should not fall until trigger is pulled.

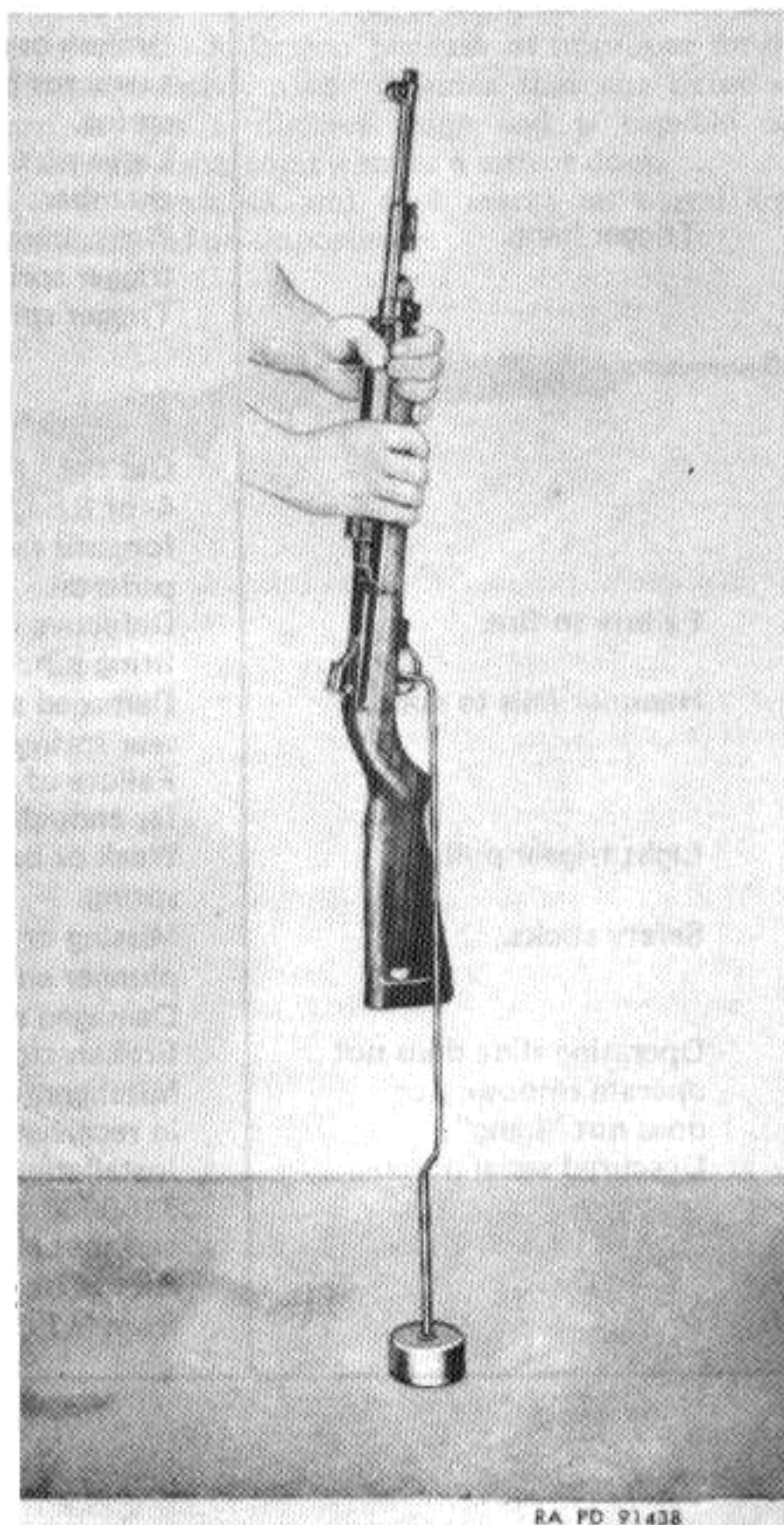

Figure 43c. Testing trigger pull.

## M1 CARBINE

Table III. Trouble Shooting

Malfunction	Probable Causes	Corrective Action
<p>Failure to eject.</p> <p>Failure to extract.</p> <p>Trigger hang.</p> <p>Failure to fire.</p> <p>Hammer fails to cock.</p> <p>Light trigger pull.</p> <p>Safety sticks.</p> <p>Operating slide does not operate smoothly or does not "hang".</p> <p>Obscured serial number.</p>	<p>Broken ejector.</p> <p>Weak or broken ejector spring.</p> <p>Damaged or broken extractor claw.</p> <p>Broken or missing extractor plunger or spring.</p> <p>Large pits in firing chamber.</p> <p>Weak, bent, or broken trigger spring.</p> <p>Trigger spring disengaged.</p> <p>Old type trigger with 4- or 8-degree angle on forward face of the pedestal.</p> <p>Defective or broken firing pin.</p> <p>Damaged sear or broken sear spring.</p> <p>Failure of bolt to move far enough to rear.</p> <p>Weak or broken sear spring.</p> <p>Missing or broken safety plunger and/or spring.</p> <p>Damaged safety.</p> <p>Broken stop and/or spring.</p> <p>Misalignment of barrel in receiver.</p> <p>Installation of rear sight 7160060 on receivers of carbines M1 and M1A1.</p> <p>Also M2 carbines converted from M1 carbines.</p>	<p>Replace ejector.</p> <p>Replace spring.</p> <p>Replace extractor.</p> <p>Replace plunger and/or spring.</p> <p>Replace barrel.</p> <p>Replace trigger spring.</p> <p>Check seating of spring in seating notch in trigger and position of spring in housing aperture.</p> <p>Replace with trigger of new design.</p> <p>Replace firing pin.</p> <p>Replace sear and/or spring.</p> <p>Check guideways in receiver for obstruction to movement.</p> <p>Replace sear spring.</p> <p>Replace safety plunger and/or spring.</p> <p>Replace safety.</p> <p>Replace stop and/or spring.</p> <p>Check parallelism of barrel and receiver and correct.</p> <p>Restamp serial number.</p>

## M1 CARBINE

- (2) With trigger held back, cock the hammer as above and allow bolt to spring forward. Hammer should not fall until trigger is released and then pulled.
- (3) With trigger released, retract bolt to cock hammer and allow bolt to spring forward. Push selector forward to place mechanism in full automatic position. Hammer should not fall until trigger is pulled.
- (4) With selector still forward, and trigger held back, retract bolt to cock hammer, then ease bolt forward slowly. The hammer should not fall until the bolt is fully locked. The hammer can distinctly be heard striking the firing pin.
- (5) Test safety with selector in both positions. It should not be possible to release the hammer with safety tang vertical.

### INSPECTION OF MATERIEL RECEIVED IN ORDNANCE SHOPS

The inspection of the weapon received in ordnance shops is essentially the same as its inspection in the hands of troops (Page 44). Table

III lists malfunctions, possible causes, and actions required to correct the malfunction.

### PRE-EMBARKATION INSPECTION OF MATERIEL IN UNITS ALERTED FOR OVER-SEA MOVEMENT

a. See table II for pre-embarkation inspection of cal. .30 carbines.

b. All URGENT Department of the Army modification work orders will be applied before approving the materiel for oversea shipment.

c. Certain small arms are manufactured with a neutral gray finish. Phosphate finish ranges from neutral gray to black and is acceptable within this color range. Rejection because of improper finish must be only on the grounds that the exterior surface has a distinct shine and is capable of reflecting light, somewhat as a mirror does.

d. Scratches and tool marks on barrel are ordinarily of no importance.





---

## V. Repair & Rebuild

---

### SECTION I. GENERAL

#### GENERAL

*a.* Information and instructions contained herein are supplementary to instructions for the using organization contained in FM 23-7.

*b.* In this manual, the main groups of the weapon are disassembled, inspected, replaced or repaired, and assembled. For information on removal and installation of groups, see page 13. A group is a number of parts or assemblies, or both, which either function together or are intimately related to each other and should be considered together (Fig. 43d).

*c.* A rebuilt flow chart (Fig. 44) and an operation route sheet (Table IV), which specify the various steps necessary in rebuilding the weapon, are contained in this chapter for the use of maintenance shops engaged in rebuild for return to stock.

*d.* Information for ordnance maintenance units engaged in repair for return to user and information for maintenance shops engaged in rebuild for return to stock are covered together, but wherever the operation is not authorized for the field level of maintenance, a note is added such as (DEPOT MAINTENANCE ONLY) to indicate the prescribed level of maintenance.

*e.* Where different standards or tolerances are prescribed for field and for depot levels, the desired standard for the particular level is similarly indicated in parentheses.

#### CLEANING AND LUBRICATION

Degrease, clean, and oil all materiel received in ordnance shop. Keep a light film of oil on all parts undergoing rebuild operations to prevent rust from forming on surfaces. Processed materiel in the shop should be kept clean and oiled at all times to prevent rusting. Information and instructions pertaining to cleaning, preserving, sealing, and related materials, are contained in TM 9-850. For detailed instructions for care and cleaning of the carbine, see page 32.

#### GENERAL REPAIR AND REBUILD METHODS

*a.* The foreman in charge of repair and rebuild will procure a complete set of special tools. The number of units to be processed will determine the disposition of manpower and job procedure, and the extent to which improvised tooling, assembly line methods, and special shop provisions are justifiable.

*b.* Precision tools for inspection of critical dimensions and tolerances will be provided where necessary.

*c.* Use only tools that fit snugly as loose fitting tools may damage part.

*d.* It is the responsibility of personnel engaged in disassembly to inspect parts as they are removed. Irreparable parts should be dropped from flow of parts as soon as possible.

e. Parts damaged to the extent that the cost of repair is greater than their replacement cost, should be discarded.

**REMOVAL OF RUST AND FINGERPRINT DEPOSIT**

a. Light rust may generally be removed with a cloth moistened with preservative lubricating oil or rifle-bore cleaner. If this does not suffice, use crocus cloth or fine abrasive cloth. Take care not to scratch or alter cleaned surfaces, to remove thoroughly all dirt and abrasive, and to reoil surfaces before assembling the parts.

b. For removal of deposits caused by the acid reaction of the fingerprint on the metal of unpainted machined surfaces, use fingerprint remover oil 14-C-789-25.

**REMOVAL OF BURRS FROM THREADS, SCREW HEADS, AND WORKING AND WOODEN SURFACES**

a. During the life of the carbine, polishing and stoning are necessary to relieve friction and to remove burrs set up by firing and usage. Remove burrs on screw heads, threads, and like surfaces with a fine file, or chase out with a corresponding sized die or tap. Remove burrs on working surfaces, such as bolt lugs, operating slide grooves, etc., with a fine grain sharpening stone. Smooth rounded contacting surfaces with crocus cloth.

*Caution:* Be careful to stone and file evenly and lightly and do not remove more metal than is absolutely necessary. Never alter parts or assemblies in any way that will affect interchangeability or proper operation or function. If parts are so damaged that critical dimensions would be changed by filing or stoning, replace with a part from stock.

b. On wooden components, dents or mutilations that do not affect strength or general appearance may be sanded out. Wood dough may be used if practicable. Unvarnished wooden components, such as stocks and hand guards, should be sanded all over and treated with linseed oil, mixed with an approved fungicide if inspection reveals presence of fungus. Patching is permitted where strength is not affected. See page 93 for repairs and patching of wooden components. Points that bind may be relieved by filing or paring using a fine file or sharp flat blade.

**REPLACEMENT OF SPRINGS**

All springs that are corroded, set, weak, distorted, or fail to meet standards are to be replaced. Refer to TB ORD 366 for coil spring standards.

**MARKING OF REBUILT WEAPONS**

All carbines rebuilt must be stamped with the initials of the rebuilding establishment in the United States; weapons rebuilt by oversea depot shops are not to be stamped. Stamp the initials identifying the establishment rebuilding a carbine on the left side of the stock between the hand grip and the butt plate. If the weapon is subsequently rebuilt at another establishment, place the new identifying initials directly below those preceding. If the weapon is rebuilt at the same establishment as before, new initials need not be added. The establishments and the initials to be used are as follows:

Augusta Arsenal . . . . .	AA
Benicia Arsenal . . . . .	BA
Mt. Ranier Ordnance Depot . . . . .	MR
Raritan Arsenal . . . . .	RA
Red River Arsenal . . . . .	RRA
Rock Island Arsenal . . . . .	RIA
Springfield Armory . . . . .	SA

**FIRING TESTS**

a. *Function Firing.* Following repair or complete rebuild, fire each M2 and M3 carbine 10 rounds full automatic and 10 rounds semi-automatic. Fire each M1 and M1A1 10 rounds semi-automatic. If carbines do not function satisfactorily, additional rounds are authorized. Function firing is required, in field maintenance, only when adequate facilities are available. Quality controlled function firing may be used provided the number of weapons to be function fired is sufficient to warrant.

b. *Function Tests.* Function tests should be shot from the shoulder or from a buck, spring loaded to simulate actual recoil conditions. A spring which allows the carbine to recoil approximately one-half inch is acceptable. If function tests indicate a lack of power, improvement may be secured through the use of the counterbored type pistol nut 5196436 which permits longer travel of the piston. Thus nut differs from the

## M1 CARBINE

plain type in that it has a counterbored piston seat in the forward end approximately 0.030 inch deep (Fig. 43e).

**Warning:** A semi-automatic or automatic weapon which functions satisfactorily in a test that allows no recoil, may not function at all when fired under field conditions because of insufficient power. It is important, therefore, that the function tests be conducted properly. This is particularly important in the case of carbines M2 and M3.

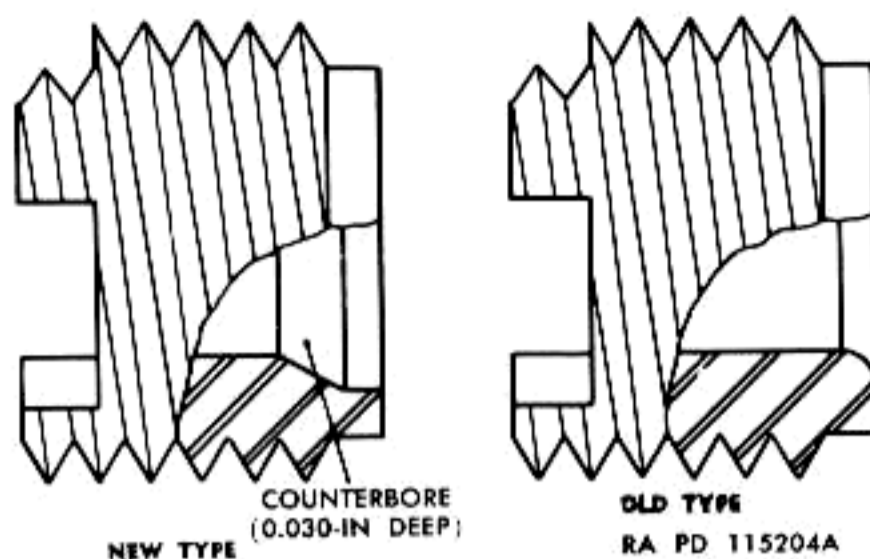

Figure 43e. Piston nut 5196436.

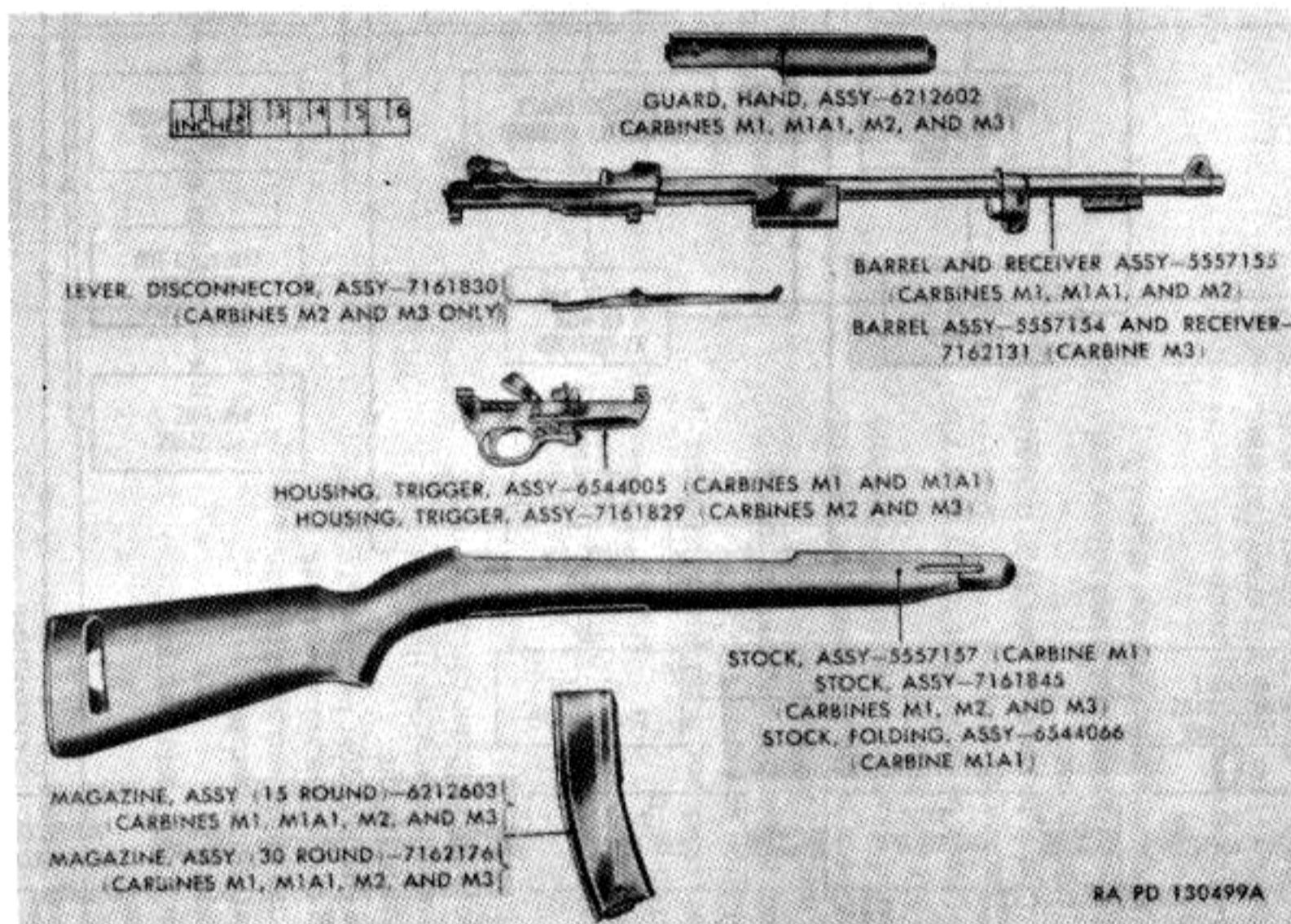
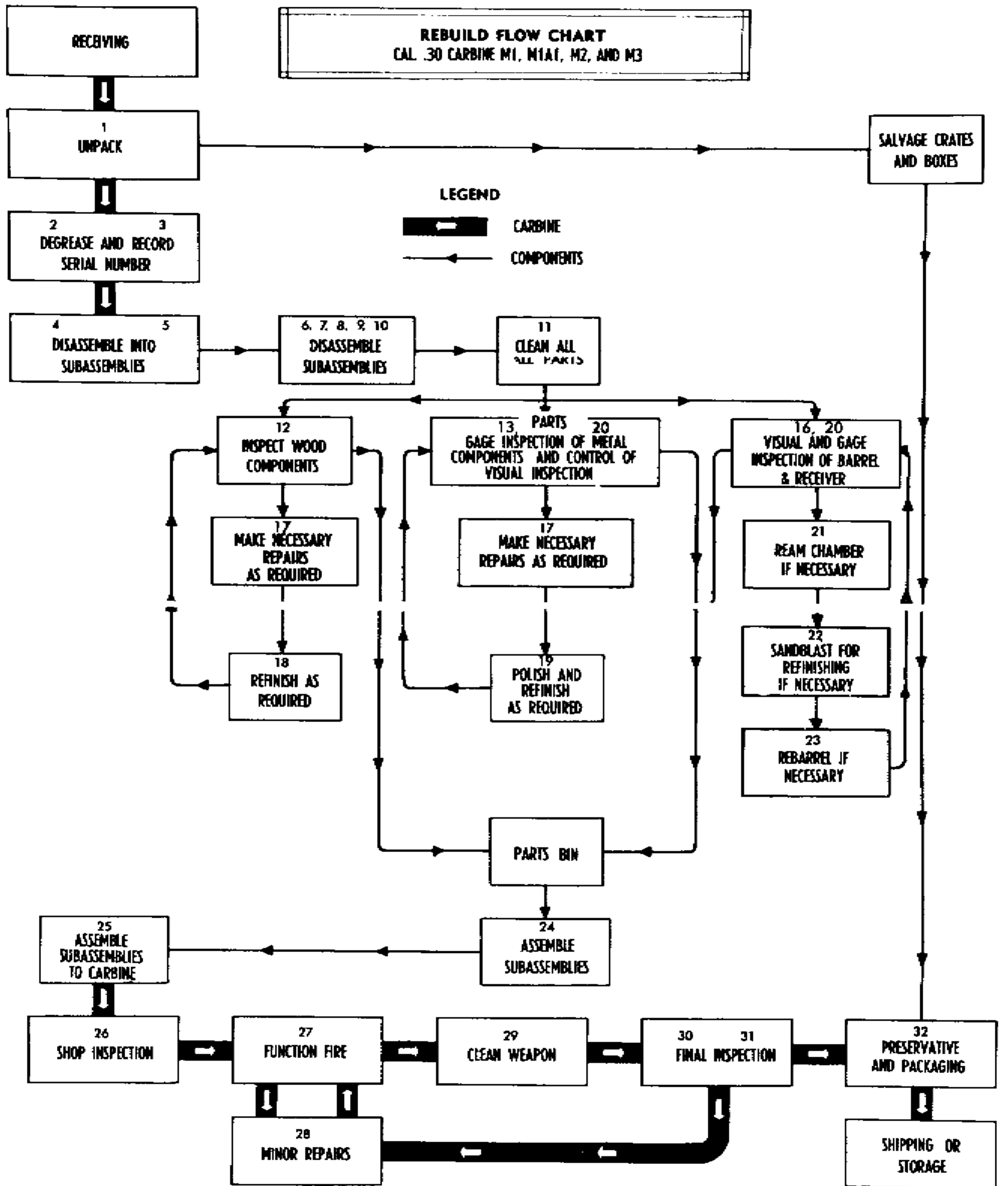

Figure 43d. Assemblies comprising the weapon shown in relative positions.

# M1 CARBINE

## Section II. REBUILD FLOW CHART



RA PD 130491

Figure 44. Rebuild flow chart.



Table IV. Operations Route Sheet for cal. .30 Carbines M1, M1A1, M2, and M3

Operation, No.	Operation	Machine	Fixtures	Tools	Gages
1	Unpack				
2	Check for live ammunition				
3	Degrease	Vapor degreaser			
4	Record serial number				
5	Remove stock and hand guard				
6	Disassemble into subassemblies				
7	Disassemble trigger housing group			7160026	
8	Disassemble bolt			7313298	
9	Disassemble operating slide				
10	Remove gas cylinder pistol and nut if necessary	Vise		5621065	
				or	
				7160995	
11	Remove front and/or rear sight if necessary	Vise		7160026	
				7312068	
12	Clean all parts				
13	Inspect stock and hand guard for dents, mutilation and cracks				
14	Inspect trigger housing and components	Comparator	7319701		7317838
	a. Inspect for wear.		7319811		7317839
	b. Check to see that new type hammer and spring are used for the carbines M1 and M1A1.		7319882		7317840
	c. Check to assure that rotary safety is used on all carbines.				
	d. Check to see that new type magazine catch is used.				
	e. Check to see that latest safety and magazine catch plunger assembly is used.				
15	Inspect operating slide group				
	a. Inspect for wear and cracks of slide.				
	b. Check to assure that new type stop and spring are used.				
	c. Inspect slide spring and guide for rust, deformation and wear.				

M1 CARBINE

Table IV continued.

Operation, No.	Operation	Machine	Fixtures	Tools	Gages
16	<b>Inspect bolt</b> a. Inspect for wear. b. Check to assure that new unused extractor, spring and plunger (new type) are used. c. Check for modified or new type firing pin.				
17	<b>Inspect barrel and receiver</b> a. Check for looseness and alignment. b. Inspect for wear and cracks in receiver. c. Inspect barrel and receiver for serviceability. d. Inspect gas cylinder group. e. Check for obscured serial number. f. Check head space.	Vise			7319932 7319934 7319936 7319938 7319943
18	<b>Make replacement of parts and repairs as required</b>				
19	<b>Refinish as required</b>				
20	<b>Polish and refinish as required</b>				
21	<b>Inspect</b>				
22	<b>Ream chamber if necessary and check head space</b>	Vise		7319906	Gages as above
23	<b>Sandblast for refinishing if necessary</b>				
24	<b>Rebarrel if necessary and check head space</b>	Vise		7113308	
25	<b>Assemble subassemblies</b>			7160026	
				7160995	
				or	
				5262065	
				7161313	
				7312068	
				7313298	

M1 CARBINE

Table IV continued.

Operation, No.	Operation	Machine	Fixtures	Tools	Gages
26	Assemble subassemblies to carbines				
27	Inspect				
28	Function fire				
29	Do necessary repairing				
30	Clean carbine				
31	Final inspection				
32	Record serial number (optional)				
33	Preserve and pack				
<b>Note.—Repeat operations 26 &amp; 27 if repair work is performed.</b>					

M1 CARBINE

# M1 CARBINE

## SECTION III. TRIGGER HOUSING GROUP, CARBINES M1 AND M1A1

### DISASSEMBLY

a. Refer to page 14 for instructions on the removal and disassembly of the trigger housing group.

b. To facilitate the removal and installation of the trigger spring (Fig. 45), tool 7160026 has been devised, to be used as follows:

- (1) Remove the stock from the carbine.
- (2) Insert the tube portion of the trigger spring removing tool (Fig. 46) in the recess in the rear of the trigger housing containing the trigger spring; compress and retain the trigger spring within the tube of the tool.
- (3) Turn the handle of the tool one-quarter turn counterclockwise.
- (4) Withdraw the tool and spring while pushing the handle of the tool slightly to the right.

### INSPECTION

a. *General.* Inspect all parts for damage, excessive wear which might cause malfunction,

burrs, rust, foreign matter in recesses, deformation, and free action with mating parts.

b. *Trigger Housing* (Figs. 45 and 47). Inspect housing for deformation, worn (elongated) or burred pinholes, worn or burred retaining lugs, bent trigger guard bow, foreign matter in recesses, burred magazine catch guideway, and rust. Some of the fabricated (braced) type of housings were cyanide hardened during manufacture and some were not. The pinholes of the earlier ones, which were not hardened, are more subject to wear. Inspect the trigger housing group for looseness, and operation. The group should assemble easily to the receiver without apparent looseness or side play. Forward or rearward movement due to clearance at retaining pin should not exceed approximately 0.006 inch by hand test.

c. *Trigger Housing Retaining Pin* (Fig. 45). Old type of trigger housing retaining pin (with springs) must be discarded and replaced with new type of retaining pin (Fig. 48). (New type pins have no spring.) Inspect retaining pin for wear, burrs, and rust.

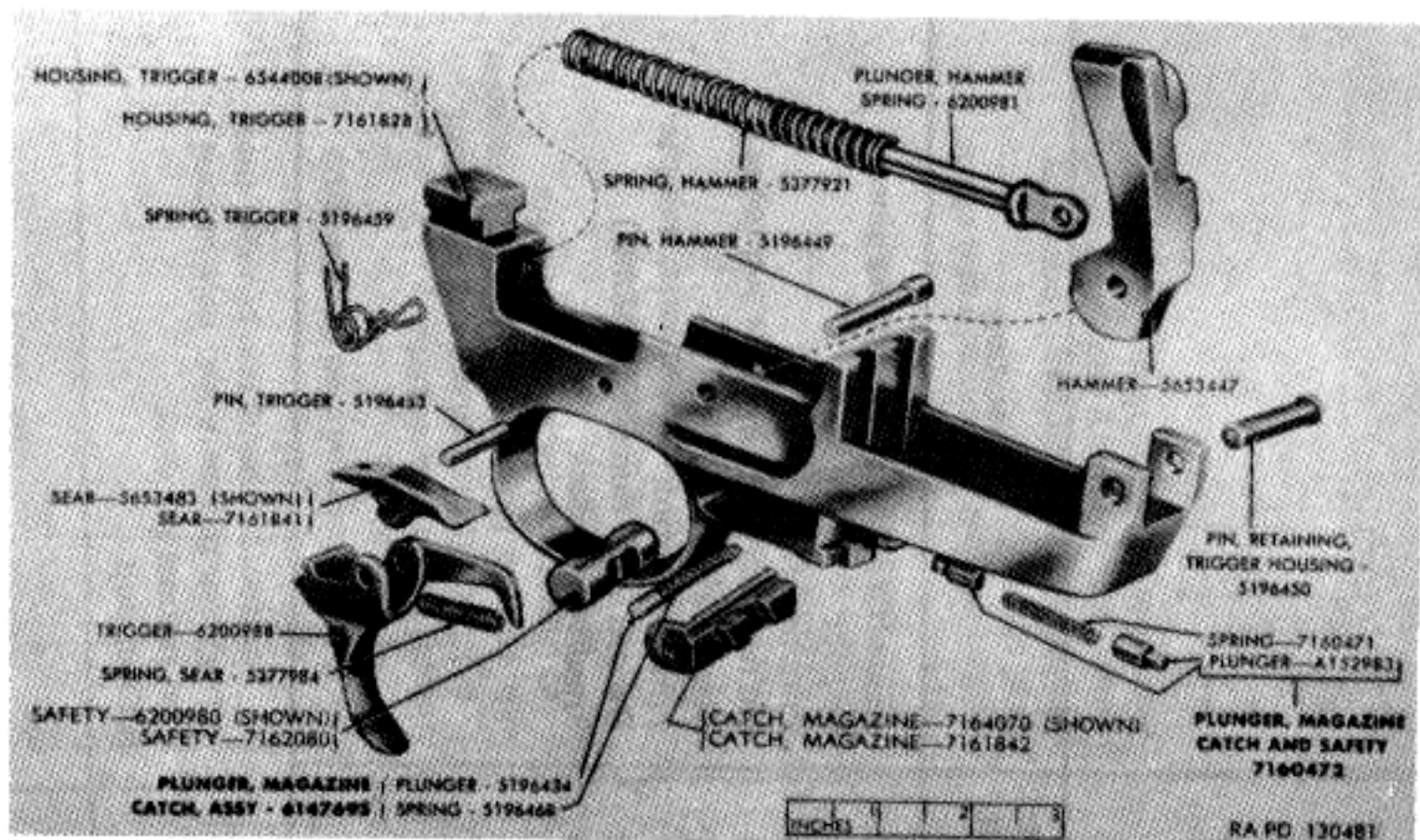

Figure 45. Trigger housing assembly for carbines M1 and M1A1 — exploded view.

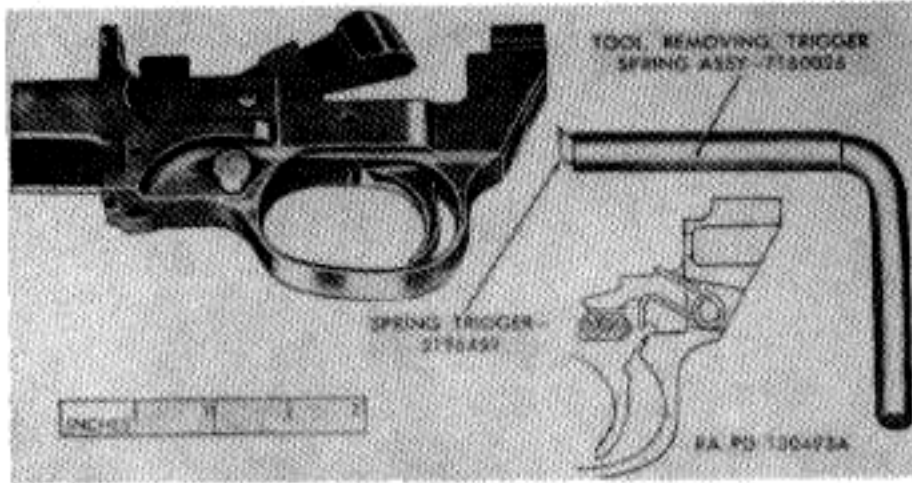

Figure 46. Trigger spring removal and installation.

*d. Hammer (Fig. 45).*

- (1) *Depot maintenance.* Inspect the hammer on a comparator where facilities are available. This applies to hammers removed from used carbines; in general, new hammers removed from stores do not require comparator inspection.
- (2) *Field or depot maintenance.* Where comparators are not available check hammer for worn pinhole, burred or dented face or bolt cam, worn or burred plunger retaining slot, burrs, and rust. Check to see that cocking cam is in good condition and that the corner of the sear notch is not rounded or broken. This corner must be reasonably sharp. Any evidence that the sear notch has been stoned is cause for rejection. Bearing face of sear notch should be level as determined by visual check (Fig. 49). Inspect hammer pin for wear and burrs, hammer for looseness on pin, and pin for looseness in trigger housing. Movement of hammer or pin should be free, but without shake. Inspect trigger housing, at point of contact with stop lug or left face of hammer, for wear and burrs.

Note. Replace early design hammer C57146 with hammer 5653447 of recent design (Fig. 49).

*e. Hammer Spring and Plunger (Fig. 45).* Inspect hammer spring plunger for deformation, wear, burrs, and rust. Inspect fit of head of plunger in slot in rear face of hammer. Head should seat evenly and positively in slot. Inspect hammer spring for functioning, deformation, and set.

Note. Replace early design hammer springs that had a free length of 2.125 inches, 22 coils, and wire diameter of 0.046 inch with hammer spring 5377921 of recent design that has a free length of 2.616 inches, 26.5 coils, and wire diameter of 0.042 inch (Fig. 50).

*f. Trigger (Figs. 45 and 51).*

- (1) Inspect the trigger on a comparator (depot maintenance) where facilities are available. This applies to triggers removed from used carbines; in general, new triggers removed from stores do not require comparator inspection.
- (2) Where comparators are not available, inspect trigger for movement on trigger pin and pin for seating in trigger housing. Trigger should rotate freely on pin but have no shake. Pin should fit snugly in housing with a push fit. Inspect clearance of trigger tip with guard, and rear of trigger with housing when fully retracted.
- (3) Inspect top of pedestal where sear seats when hammer is cocked, for levelness, wear, and burrs, and check to assure that the top forward corner of the pedestal is not rounded or broken. Triggers that are rejected for high pedestal (as determined by comparator test — DEPOT MAINTENANCE ONLY) will be retained in the shop until a sizable quantity has accumulated, then disposition instructions should be requested from Chief of Ordnance, Washington 25, D.C., ATTENTION: ORDFM. Check trigger spring notch for

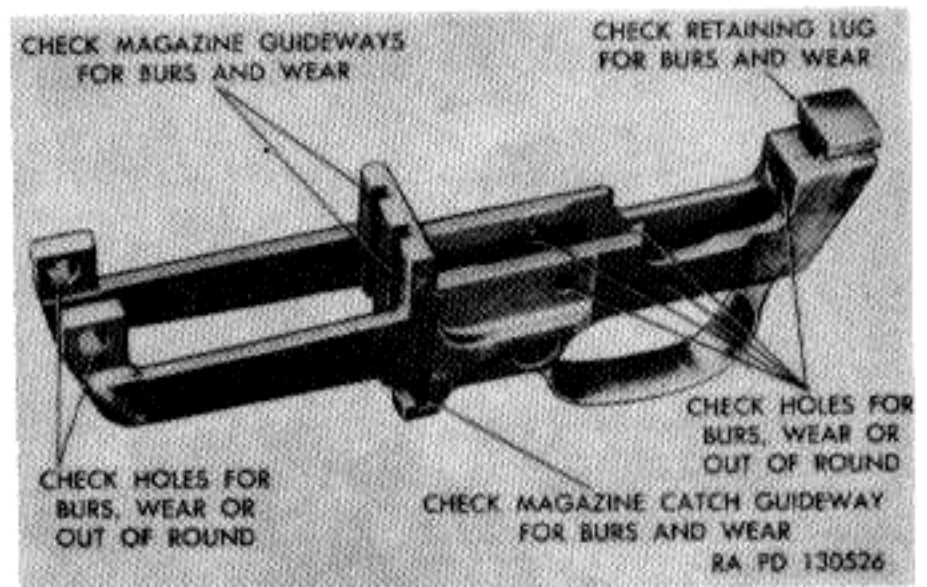

Figure 47. Trigger housing inspection points.

burrs and foreign matter. Check forward end of trigger which engages with safety for deformation and burrs. Check sear spring seating recess for foreign matter.

- (4) Test functioning of trigger to determine that trigger returns smoothly to its forward position with no tendency to stick or hang.

g. *Trigger Spring* (Fig. 45). Check trigger spring for deformation and rust. Check seating of spring in seating notch in trigger and positive retention spring in housing aperture. Bow end of spring should seat level in bottom of seating notch in trigger, and rear coiled section should be held firmly in housing aperture by the force of spring tension. Tips of spring should be slightly spread. Trigger spring should return trigger to forward position under adequate tension (FIELD MAINTENANCE).

h. *Sear* (Fig. 45).

- (1) Although sear 7161841 can be used in carbines M1 and M1A1, the available stock should be conserved for carbines M2 and M3.
- (2) Inspect the sear on a comparator (DEPOT MAINTENANCE ONLY) as facilities are available. This applies to sears removed from used carbines; in general, new sears removed from stores do not require comparator inspection.

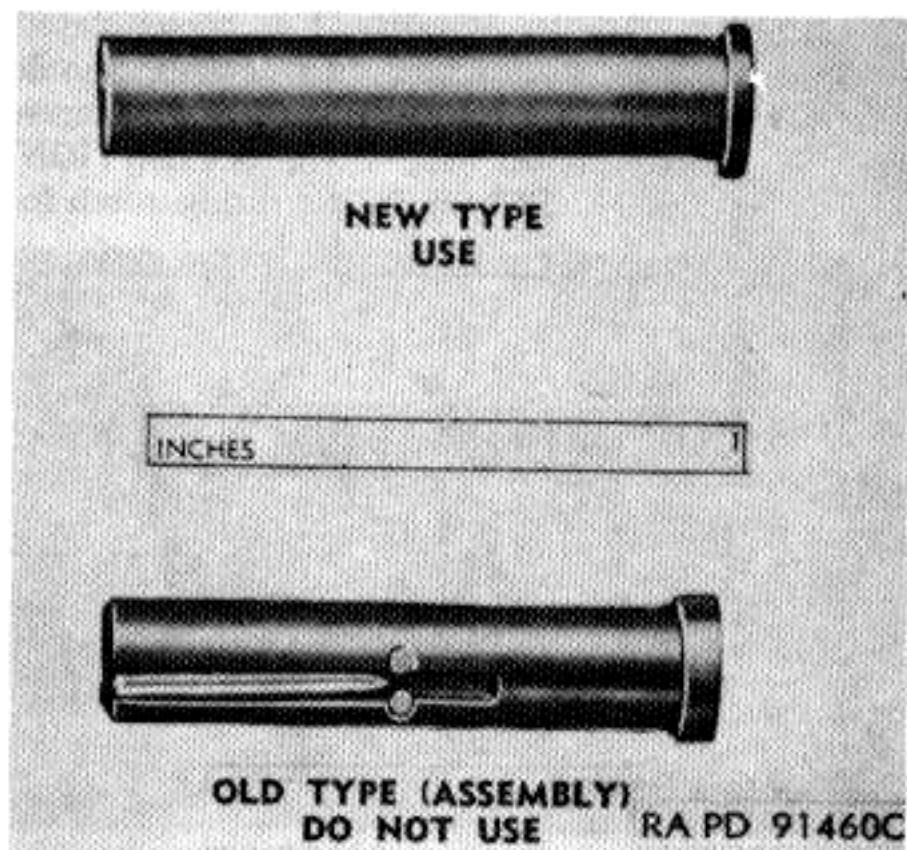

Figure 48. Trigger housing retaining pin.

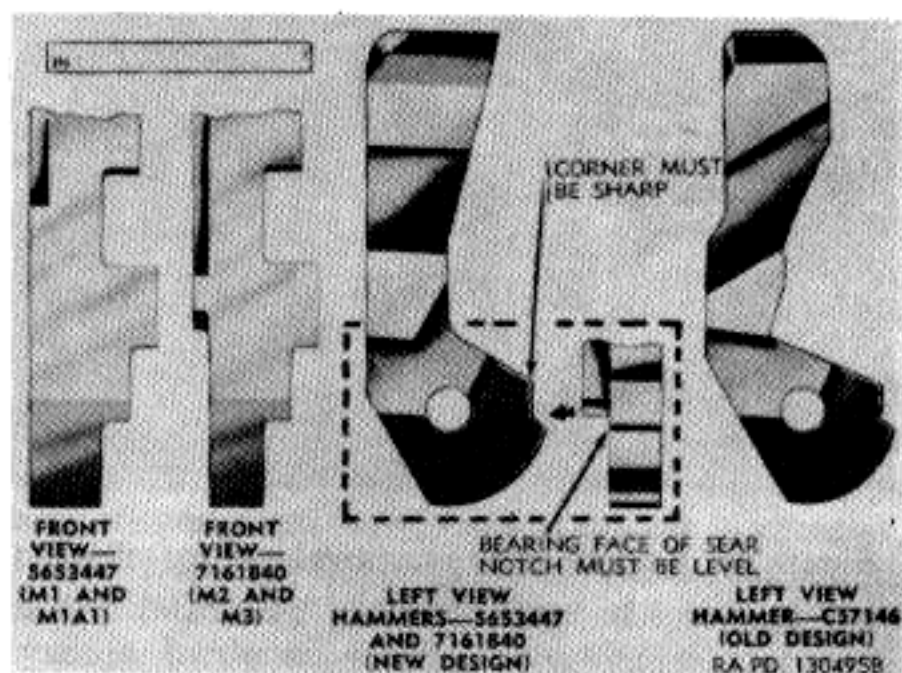

Figure 49. Old and new design hammers for carbines M1, M1A1, M2 and M3.

- (3) Where comparators are not available inspect sears carefully. The nose should have a "fine grind" surface and should have a small radius at the point where it contacts the sear surface of the hammer. The surface at the extreme rear end should be flat ground and the lower corner or edge should be sharp. Some sears 6200978 have been properly ground at each end and are usable. In this connection reference is made to Fig. 52, which is correct as far as it goes but is not complete. Sears 5653483 with the grind quality were manufactured without either of these identifying marks and these also should be used if otherwise serviceable. The important point is to assure that all sears used are those on which the nose and rear end are properly ground as mentioned above. Questionable sears should be retained in the shop until a sizable quantity is accumulated, whereupon disposition instructions should be requested of Chief of Ordnance, Washington 25, D.C., ATTENTION: ORDFM. This does not mean that all of the sears that can be determined unserviceable by visual inspection should be retained.
- (4) Check sear for movement on trigger pin. Sear should rotate freely about pin and have backward and forward movement due to elongated pinhole but should have no vertical play. Check pinhole for excessive wear.

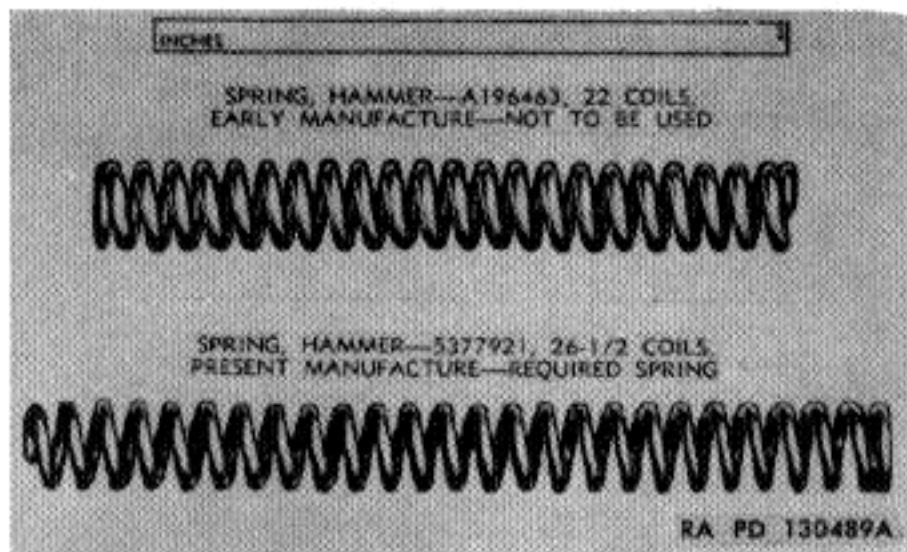

Figure 50. Hammer spring—early and recent design.

i. *Sear Spring* (Fig. 45). Check sear spring for positive seating in trigger and sear, and for functioning, rust, and set. Visually inspect during repair. Replace during rebuild.

j. *Safety* (Figs. 45 and 53). Check to assure that only the rotary type safety 7162080 is used. Modification Work Order ORD B28-W-6 prescribes the replacement of the old type safety with the new type (Fig. 53). Test safety for positive positioning. Check for burrs and rust and check spring plunger recess and trigger slot for burrs and foreign matter. Refer to paragraph l (1) and (2) below for inspection of plunger assembly for magazine catch and safety.

k. *Magazine Catch* (Figs. 45 and 54).

(1) Check to assure that magazine catch 7161842 (marked with "M" underlined) or 7160470 (marked "M" not underlined) is used. Although they are interchangeable, stocks of catch 7161842 should be conserved for carbines M2 and M3. Modification Work Order ORD B28-W-4 prescribes replacing the old type catch with the type (Fig. 54).

(2) Test the function of the magazine catch. Check catch for free movement in guideway, deformation, worn or burred retainer plunger recess, and worn or burred magazine retention lugs. See that projection on end of catch 7161842 is neither bent nor burred. Check magazine catch spring plunger for retention on spring, wear, and burrs, and check spring for functioning, deformation, and set. See table II, for standards on magazine catch spring. When magazine catch

spring is assembled, last coil of spring is contracted slightly and fits into groove in shank of plunger for retention.

l. *Plunger Assembly for Magazine Catch and Safety* (Figs. 45 and 55).

- (1) Check to assure that new type plunger assembly is used. Modification Work Order ORD B28-W-4 replaces the old type plunger assembly with the new type (Fig. 55).
- (2) Check plungers for wear and the spring for functioning, deformation and set. Refer to table II for inspection information.

Note: Use figure 55 only as a guide and not as a basis for rejection. Function test of plunger assembly during function firing is an adequate criterion for acceptance.

#### REPAIR AND REBUILD (FIELD OR DEPOT MAINTENANCE) e)

a. *General*. Replace all broken, worn, or otherwise unserviceable parts. Remove burrs and rust. Weapons must have all applicable modifications, and instructions contained in future technical bulletins must be followed. Note that certain components for carbines M2 and M3 are not interchangeable with those of the carbines M1 and M1A1, although some designed for the former can be used on the latter.

b. *Hammer Fails to Cock*. This condition may be due to damaged sear, broken sear spring, burrs or foreign matter in sear notch in hammer, or

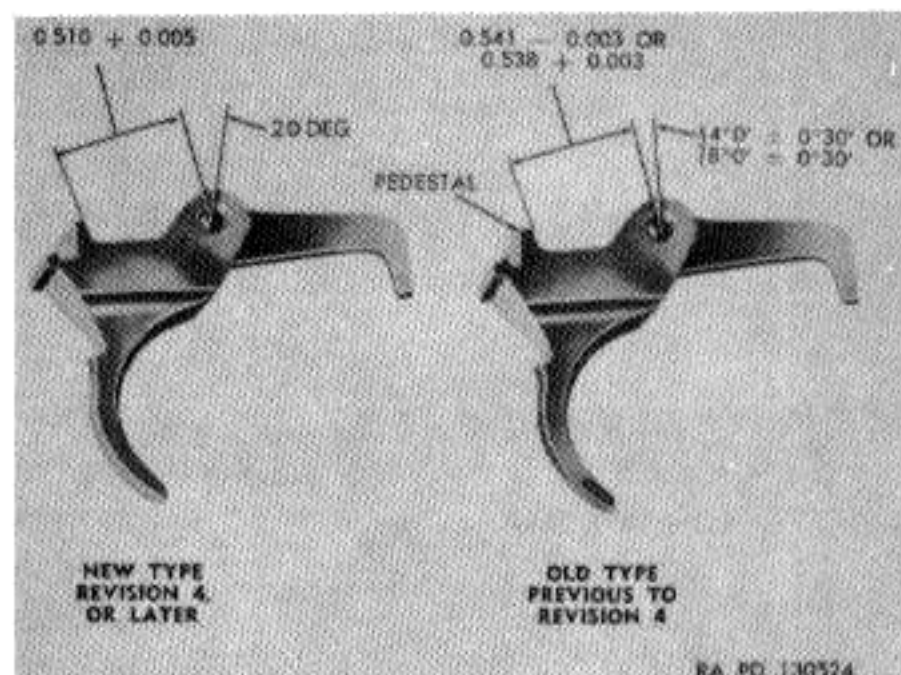

Figure 51. Trigger 6200988.

failure of bolt to move far enough to the rear on recoil movement to cock hammer. Examine parts; clean and replace if necessary.

c. *Correcting Trigger Pull.*

- (1) A light or heavy trigger pull may be caused by foreign matter or burrs in the sear notch in the hammer, on the nose of the sear, on the top of rear end lip of trigger where the rear end of sear rests, or in the elongated pivot hole in the sear from seating fully in hammer notch. To correct, remove foreign matter or replace with new components from stock.
- (2) A light pull may also be due to a weak or broken sear spring which will not seat the sear fully in the hammer notch before the pressure from hammer spring is applied to the nose of sear through the hammer. Correct by replacing sear spring.
- (3) Uneven surface of hammer notch or worn nose of sear may alter trigger pull. Correct by replacing sear or hammer.

d. *Trigger Hang.* Triggers of early manufacture had a 4- or 8-degree angle on the forward face of the pedestal which was conducive to trigger hang. When trigger hang exists, and it is not due to malfunction of the trigger spring, it can be eliminated by replacing the trigger with one of recent manufacture having an angle of 20 degrees on the forward face of the pedestal (Fig. 51). Surface must be smooth.

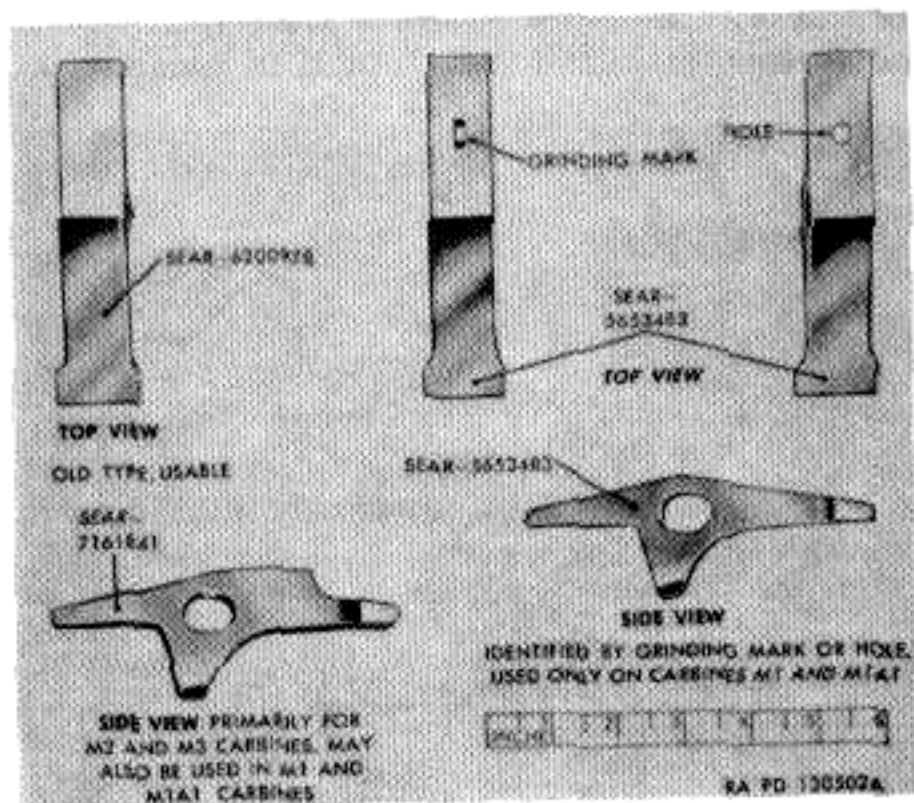

Figure 52. Sears — usable types.

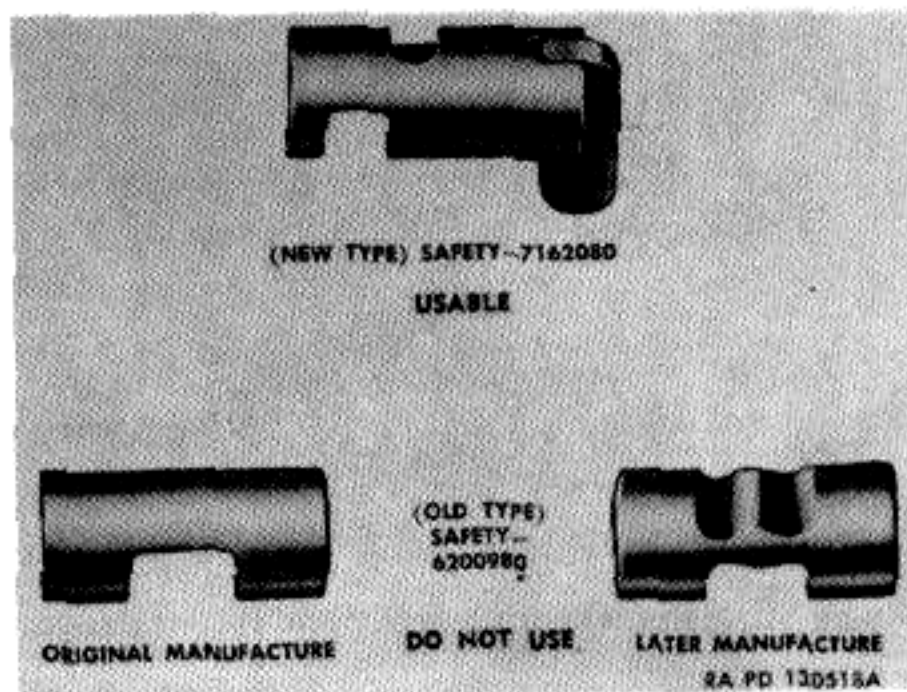

Figure 53. Safeties.

e. *Trigger Housing Loose on Receiver.*

- (1) If T-shaped lug on rear end of trigger housing becomes worn so it becomes a loose fit in retaining L-shaped lugs on rear end of receiver,peen lightly to spread lug, then file to fit. The trigger housing must be readily disassembled from receiver.
- (2) The forward lugs of trigger housing may be similarly treated to attain close fit.

*Caution:* Do not peen or squeeze in the lugs on the receiver as they are hardened. Any attempt at tightening should be done by peening of trigger housing lugs when necessary.

f. *Safety Sticks.* If the safety sticks when turned the 90 degrees, the safety spring plunger is burred or missing or the plunger seats in the safety are burred or too deep. Stone the safety for proper retention of the plunger or replace with new safety. Replace plunger or spring as required.

ASSEMBLY

a. Refer to page 13 for instructions on the assembly of the trigger housing group.

b. Using trigger spring removing tool 7160026 (Fig. 46) replace the trigger spring by reversing the procedure of removal. When the spring is in position in the retaining groove of the trigger, depress the trigger and withdraw the tool from the housing. Install the stock on the carbine.



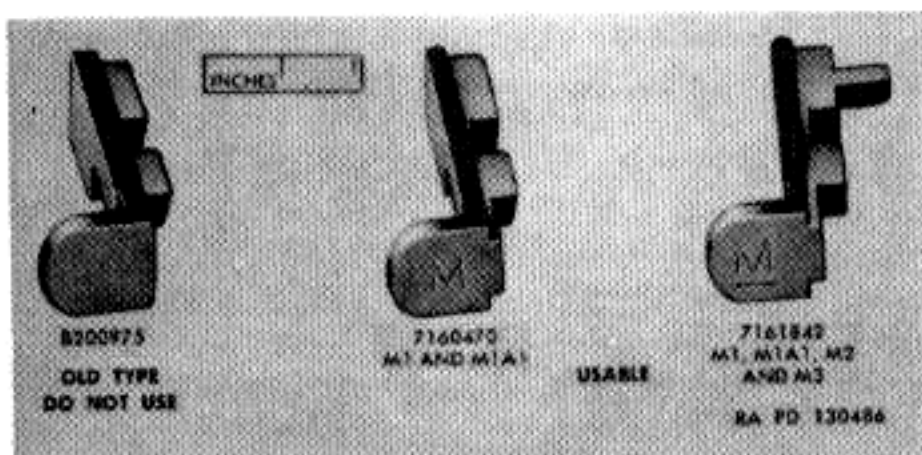

Figure 54. Magazine catches.

### FUNCTIONAL CHECK

a. Cock hammer and check seating and positive retention to limit of sear nose in hammer notch. Continue to retract hammer rearward and observe forward movement of sear to maintain retention. Sear should continue to contact hammer throughout movement. Pull trigger; sear should release hammer crisply. Release trigger. It should move positively to forward position under force of trigger spring and be held there firmly and without shake even when sear is not assembled. When trigger is in forward position and hammer cocked, the sear should rest upon or above top of rear pedestal of trigger.

b. Check trigger pull. See page 50 for instructions on the checking of the trigger pull.

c. Check to assure that hammer and sear reengage when trigger is pulled back far enough to cause perceptible movement of hammer and then released.

d. Check to assure that trigger guard is not bent and does not interfere with functioning of trigger.

e. Check to assure that safety functions properly. It should block the trigger when set on safe (tang vertical) and permit release of the hammer when the tang of the safety is pointing to the rear.

f. Check functioning of the magazine catch to assure that it operates properly and does not bind. Inspect each assembly to assure that the magazine catch can be pushed rearward in its ways in the trigger housing, and that the safety plunger spring is strong enough to return it firmly to the forward position. Check each safety by rotating it to both positions to assure that the retention effect of the spring is sufficiently strong to hold it firmly in the position desired. It shall be determined that the forward pressure on the magazine

will not prevent proper sidewise travel of the catch.

g. With trigger housing group assembled to the receiver, check to assure against looseness which would affect functioning. The retaining pin must fit tightly enough to remain in position yet permit ready disassembly by hand. The trigger housing group must be readily disassembled from the receiver.

### SECTION IV. TRIGGER HOUSING GROUP, CARBINES M2 AND M3

#### DISASSEMBLY (FIELD OR DEPOT MAINTENANCE)

a. To remove the trigger housing group the disconnecter lever must first be removed, as the disconnecter lever pin locks the housing to the receiver.

b. To remove the disconnecter lever, move the selector to its rearward position and push the selector spring up the slot in the housing magazine post to the dismounting notch and withdraw, using a drift or the operating slide spring guide. Slide the selector off the disconnecter lever pin. The disconnecter lever can then be withdrawn and the trigger housing separated from the receiver.

c. The disassembly of the trigger housing group is the same as for the carbines M1 and M1A1.

d. To reduce loss of disconnecter spring plunger assembly when removing trigger housing group from barrel and receiver assembly of M2

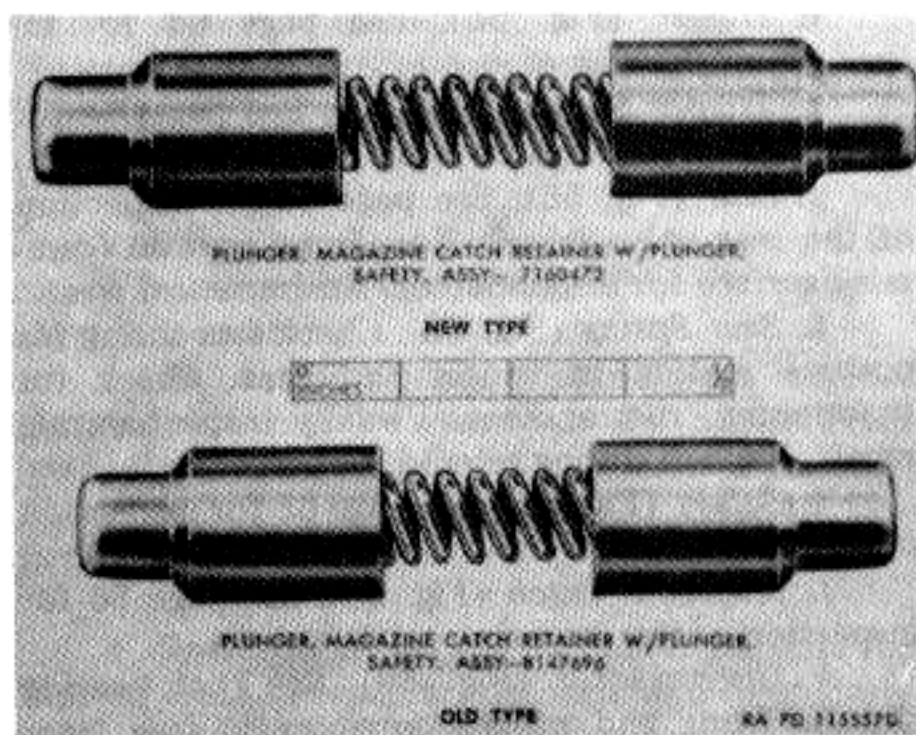

Figure 55. Plunger assemblies for magazine catch and safety.

## M1 CARBINE

and M3 carbines, MWO ORD B28-W7 prescribes the following changes:

PART NO.	ITEM	REPLACES
7162780	Spring, disconnecter	Spring 7161836
7162781	Plunger, disconnecter	Plunger 7161835

The above items are components of:

7162782	Plunger, disconnecter spring, assembly	Plunger, assembly 7161834
---------	--	---------------------------

### INSPECTION

*a. General.* Inspect all parts for damage, excessive wear which might cause malfunction, burrs, rust, foreign matter in recesses, deformation and free action with mating parts. Reference is made below to pages in the preceding section for inspection of corresponding components of the trigger housing group.

*b. Trigger Housing* (Fig. 56). See page 62 for inspection of the trigger housing. Also inspect the selector spring retention slot in left magazine post for foreign matter and positive spring seating so that spring will not turn when assembled.

*c. Hammer* (Fig. 56). See page 63 for inspection of the hammer. Also inspect milled cut on lower right sight of hammer, which allows clearance for disconnecter, for burrs and wear (Fig. 49).

*e. Trigger* (Fig. 56). See page 64 for inspection of the trigger.

*f. Trigger Spring* (Fig. 56). See page 64 for inspection of the trigger spring.

*g. Sear* (Fig. 56). See page 64 for inspection of the sear. Also inspect top front portion (camming surface for disconnecter) for burrs and wear.

*h. Sear Spring* (Fig. 56). Check sear spring for positive seating in trigger and gear. Check for functioning, rust and set. Visually inspect during repair. Replace during rebuild.

*i. Safety* (Fig. 56). See page 65 for inspection of the safety.

*j. Magazine Catch* (Fig. 56). See page 56 for inspection of the magazine catch.

*k. Disconnecter* (Fig. 56). See that bearing slot in front end of disconnecter is free from foreign matter and burrs and is lightly lubricated. See that disconnecter spring is not weak, rusted, or broken, that spring well is free of foreign

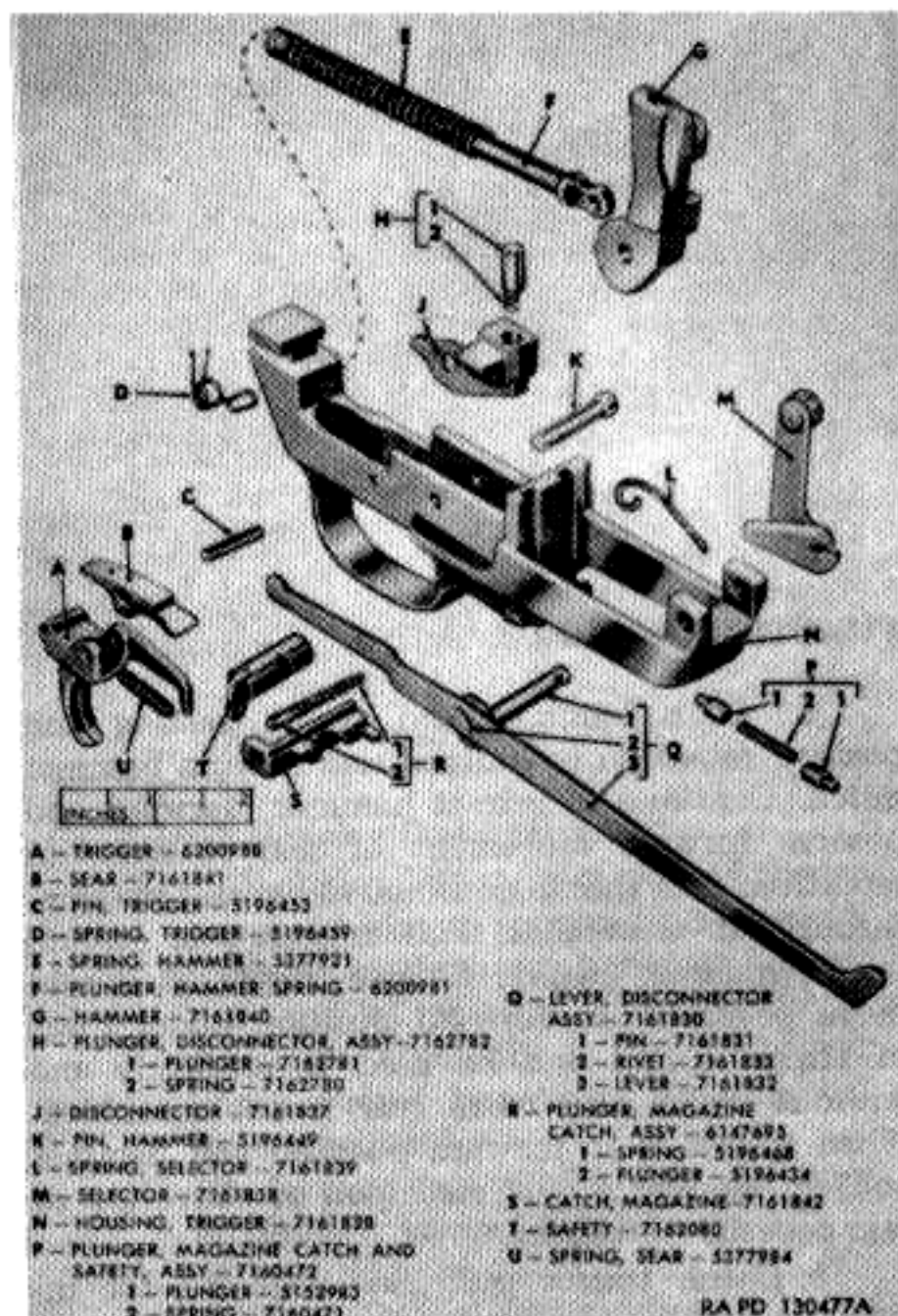

Figure 56. Trigger housing group - carbines M2 and M3.

matter, and that plunger is free of burrs. Lubricate plunger occasionally. Expanded end of coil of spring should seat in plunger for retention. Check rear end of disconnecter for burrs and wear.

*l. Disconnecter Lever Assembly* (Fig. 56). Examine the rivet of the disconnecter lever assembly which pivots the lever in the flat crank shaped end of the pin, to determine that the rivet is secure, that the hole in the crank of the pin is not enlarged, that this pivot is free from burrs, and is not worn. See that lever is not distorted or twisted on rivet, that it is free to rotate on the rivet and that ends are free from burrs and wear. Offset in rear section of lever is for alignment with disconnecter and should not be straightened. Be sure toe (front end) of lever bears squarely on cam on operating slide and is (slide retracted) under raised boss when lever is fully seated in the housing. See that holes in trigger housing for pin of disconnecter lever assembly are not enlarged.

## M1 CARBINE

Rear end should not bind in cam of disconnecter when assembled. Examine pin of disconnecter lever assembly to see that pivot areas are free from burrs and not worn. Keep pivots lightly lubricated. If the pin is rotated by the selector so as to permit inadequate positioning of lever in full automatic fire, inspect the straddle cuts in pin which engage the selector. They must be free from burrs, must retain selector firmly, and must not be worn so as to cause lost motion.

*m. Selector and Spring* (Fig. 56). See that disconnecter pin slot in selector is not worn so it will cause lost motion or impair security. See that spring recess in rear end is free from foreign matter and will retain spring securely. See that selector spring is bent in only one plane (not twisted) and both ends seat securely in their retention recesses. If spring is loose when assembled, straighten slightly.

### REPAIR AND REBUILD

The repair and rebuild of the trigger housing group is essentially the same as for carbines M1 and M1A1. See page 65.

### ASSEMBLY

*a.* The assembly of the trigger, trigger spring, sear and sear spring is the same as for the carbines M1 and M1A1 (page 66). Use sear 7161841 (page 64) and magazine catch 7161842 (page 65) marked with underlined letter "M" on all carbines M2 and M3. To assemble the disconnecter and hammer, place the disconnecter in trigger housing so that the lug projects over the right side of the housing. Insert the hammer on the left of the disconnecter so that its milled lower cut presses against the flat portion of the disconnecter. Insert the hammer pin from the left side and through the hole in the hammer, line up the hole in the disconnecter and push the pin through the hole in the other side of the housing. With the pin head on the left side, the pin is prevented from shifting when the carbine is assembled.

*b.* Insert disconnecter spring plunger assembly into the hole in the top of the disconnecter, spring first. Use disconnecter spring plunger assembly 7162782 on all carbines M2 and M3. Line up the trigger housing with the receiver and insert the disconnecter lever pin from the right side with the long leg of the lever towards the front. The rear toe of the lever should rest on the bottom surface of the projecting lug of the dis-

connector. Slide the slot of the selector through the grooves of the projecting portion of the disconnecter lever pin. Pivot the selector to the rear position and insert straight end of the selector spring into the recess in the lower rear end of the selector; with the loop of the spring downward insert the loop end into the slot in housing magazine left post mounting slot and down to the bottom of the post.

### FUNCTIONAL CHECK

*a.* For functional check of the trigger housing, hammer, trigger, sear, magazine catch, and trigger pull, see page 67.

*b.* Set for semiautomatic fire. Squeeze the trigger, cock the hammer, and forcibly strike the grip of the stock with the heel of the hand several times. If the hammer falls, the group is not acceptable because it will tend to fire in an uncontrolled manner.

*c.* With the trigger housing assembled to the receiver, check functioning of all moving parts at full and semiautomatic settings.

*d.* Check to assure that there is no binding between hammer, disconnecter, and housing.

*e.* When the carbine M2 is set for automatic fire with the trigger pulled back, the hammer must fall when the operating slide is slowly pushed all the way forward. When set for semiautomatic fire, the toe of the disconnecter lever should clear the cam on the operating slide to assure that the hammer will not be released.

*f.* Check trigger pull (page 50).

### SECTION V. OPERATING SLIDE ASSEMBLY

#### DISASSEMBLY

*a.* Refer to page 7 for instructions on removal from carbine and disassembly of the operating slide assembly.

*b.* Before the operating slide on the carbines M2 and M3 can be removed, the disconnecter lever must be removed first.

#### INSPECTION

*a. Operating Slide* (Fig. 57). Check slide for bent or cracked rear bar, deformation, excessively worn guide lugs, burrs, and corrosion. Inspect bolt camming lug recess for wear and burrs. Inspect spring guide seating recess in rear face for wear, burrs, and foreign matter. Inspect front race of

# M1 CARBINE

slide where it contacts piston for levelness. Unevenness at this point may cause malfunction. Check camming surfaces for burrs and wear (Fig. 58). Inspect the operating slide under "black light" for cracks in the areas specified below (DEPOT MAINTENANCE ONLY). Reject slides having cracks around the operating cam, at the junction of the inertia block and arm, and around the disconnecter lever cam on M2 type slide 7161843. Check visually and reject operating slides showing breaks around the hole for the operating slide stop. Cracks at this point are acceptable. Use operating slide 5357151 (usable) or operating slide 7160091 (preferred) on carbines M1 and M1A1 until the supply is exhausted, then use 7161843 (Fig. 58). Until the supply of the two former slides is exhausted, conserve operating slides 7161843 for use on carbines M2 and M3.

*b. Operating Slide Stop and Stop Spring (Fig. 57).*

- (1) For depot maintenance, check to assure that stop 7312452 and spring 7312453 are used. For field maintenance, old type is satisfactory if it functions properly.

- (2) Inspect stop for wear and burrs, looseness in operating slide, and rust. Inspect stop spring for functioning, lack of friction with stop, and for set. Inspect spring for foreign matter.

*c. Operating Slide Spring (Fig. 74).* Inspect operating slide spring for set, broken coils, and distortion. Refer to TB ORD 366 for operating slide spring standards.

*d. Operating Slide-spring Guide (Fig. 74).* Inspect operating slide spring guide for deformation, burrs worn or burred nose, and rust. Shank of guide should be straight. Nose of guide should be free from burrs to insure positive seating in its recess in rear face of operating slide. With spring assembled to guide, insert in housing, or in housing tube in early type receivers, and hand operate to test freedom of movement.

*e. Slide Spring Housing (early type receivers).* Inspect inside and outside of operating slide spring housing for dents, splits, rust, and foreign matter. Inspect spring retainer for looseness in tube and positioning lug on retainer for burrs and wear. Some tubes have a pressed out lug on the side and a slot in the rear. This lug seats in the operating

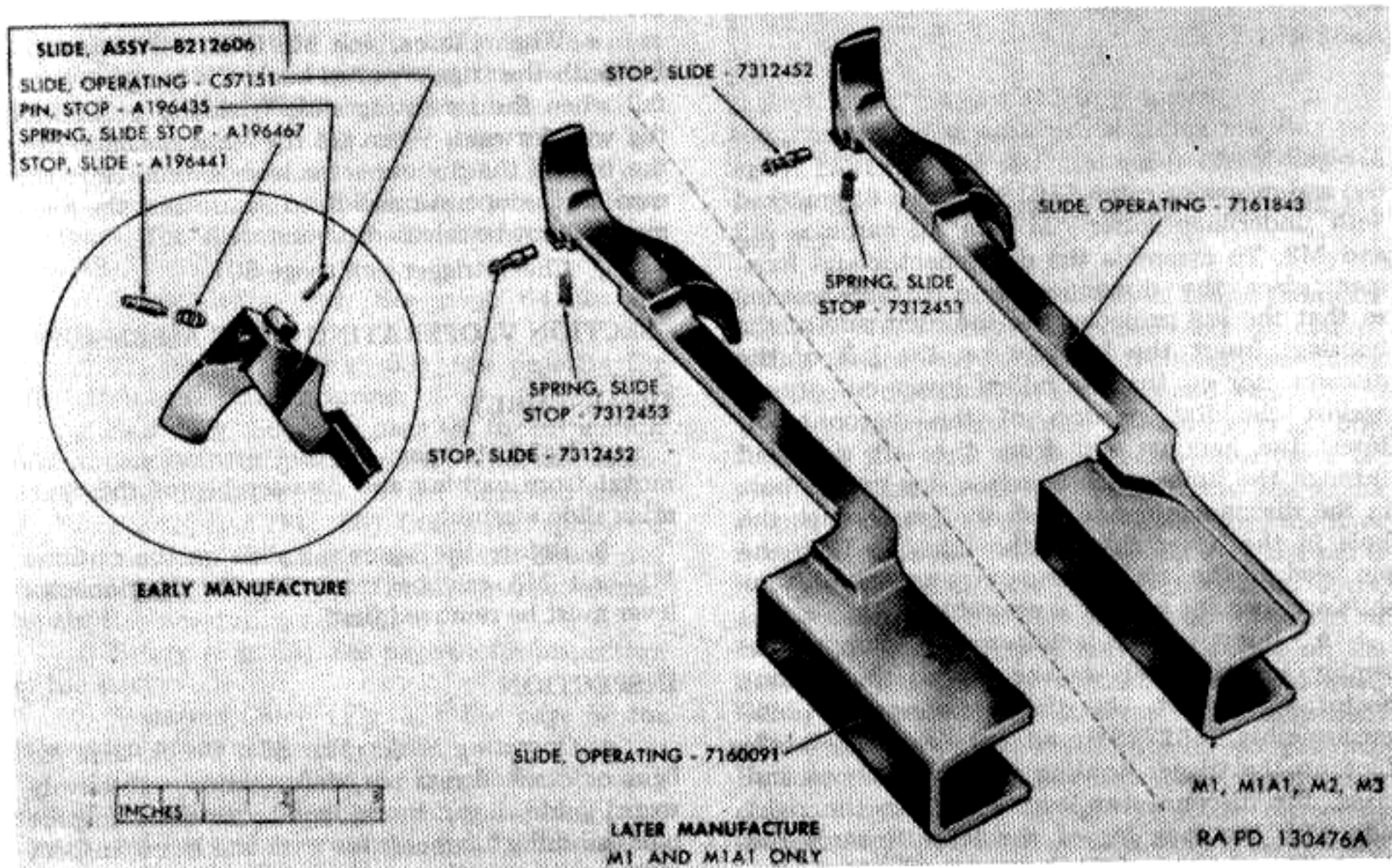

Figure 57. Operating slide assembly.

slide dismounting slot in the receiver (limited design), and the rear slot mates with a small projecting lug in the rear end of the housing tube bed groove in the receiver. The lug should not be bent or burred, and the edges of slot should be clean. If lug is damaged or missing, replace the tube with a new one.

Note. Do not use these early type receivers in rebuild.

**REPAIR AND REBUILD (FIELD OR DEPOT MAINTENANCE)**

a. In the early type receiver which contains the operating slide spring tube, if the retainer in the rear end of the tube becomes loose, tighten it by crimping tube in with cold chisel. If too loose to be easily tightened, replace the housing assembly. Repair and rebuild of the operating slide assembly consists of replacing worn, damaged parts and elimination of burrs, etc.

b. It is advisable to drill a 3/16-inch hole through the rear end of the receiver into the operating slide spring hole for the purpose of having good circulation of phosphating solution and preservative compounds.

**ASSEMBLY**

Refer to page 13 for instructions on the assembly of the operating slide assembly.

**FUNCTIONAL CHECK**

A. Check slide to assure that the operating slide stop, spring, and pin (slide 5557151) have been assembled. Check the functioning of the stop by hand to assure that the spring exerts sufficient pressure on the stop to retain it firmly.

b. With operating slide assembled to barrel, receiver, and bolt, and without slide spring and guide assembled, manually operate slide and check for smoothness of operation of bolt and slide. Inspect bolt camming recess for retention with bolt cam lug, and operating slide rear guide lug for retention with guideway in receiver. It should not be possible to disengage slide from guideway in receiver. A slight pull out and up at rear end of guideway should disengage slide from receiver, but not from bolt cam lug. This should not be possible, without undue force, until barrel guide lugs on slide are aligned with relief cut in left barrel guideway and slide is rotated. If slide can be

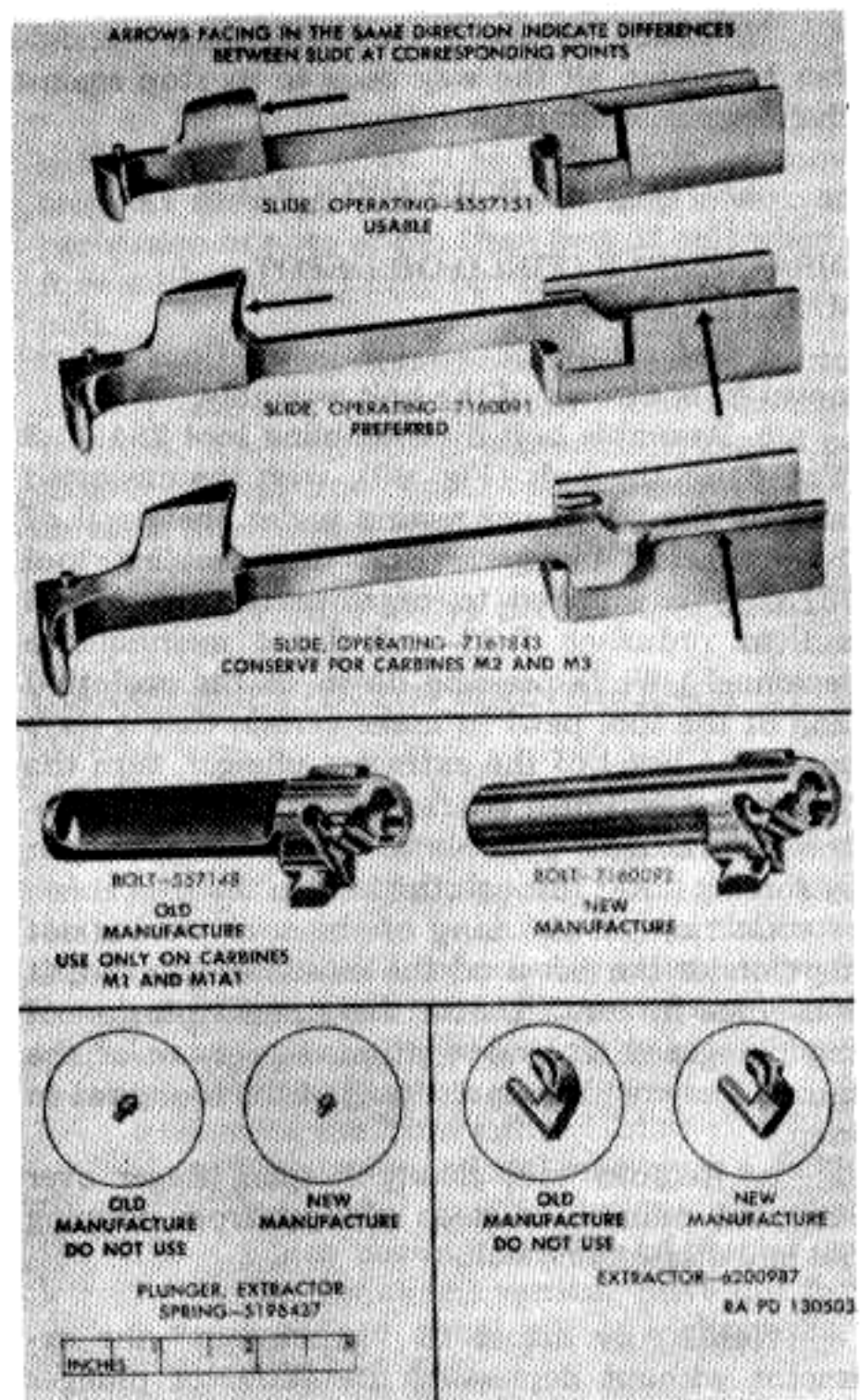

**Figure 58. Slide, bolt, extractor and plunger.**

disengaged otherwise, rear bar is bent or guide lugs are excessively worn.

c. With operating spring and guide installed, test function of operating slide stop. When bolt is fully retracted and stop pressed into its retaining groove, it should positively "hang" slide and bolt in that position. If slide does not remain in rearward position, the stop and/or retaining groove are worn or stop friction spring is missing, broken, or set. Stop should be cammed out of groove and lie flush with bottom surface of slide when bolt is retracted. Friction pressure of stop spring should be sufficient to hold stop positively in retracted position notwithstanding jar of bolt at end of rearward movement. (Stops of early design were spring retracted when slide was moved slightly to rear to relieve friction between stop and face of notch in receiver.)

d. Check to assure that the operating slide can be drawn all the way back to its stop against the receiver without binding.

### SECTION VI. BOLT GROUP (Fig. 59)

#### DISASSEMBLY (FIELD OR DEPOT MAINTENANCE)

a. Refer to page 13 for instructions on removal from carbine of the bolt assembly.

b. Assemble bolt disassembling tool 7313298 (Fig. 6) to the bolt (Fig. 60), with the unslotted tang of the tool pawl resting under the bevel of the extractor plunger. (Bolt disassembling tool 7313298 is supplied to organizational personnel and to ordnance field and depot maintenance personnel.) While pressing down on the unslotted tang of the tool pawl to make certain that it stays under the bevel of the extractor plunger, turn the thumb screw until the extractor plunger is depressed making it possible to remove the extractor by forcing it out through the hole in the tool.

*Caution:* If the tang of the tool pawl is not kept under the bevel of the extractor plunger, it will come in contact with the straight portion of the plunger shaft and continued pressure of the thumb screw will cause the tang of the tool pawl to snap.

c. Remove tool slowly keeping finger over tang and plunger to keep plunger from popping out and disassemble bolt.

*Note.* Any effort to "punch out" the extractor without depressing the extractor plunger will shear off the plunger or the extractor retaining lip. The plunger must be depressed before the plunger is "punched out."

#### INSPECTION

a. Inspect bolt for cracks (under "black light" in depot maintenance), paying particular attention to the area around the right hand locking lug. Bolts having cracks must be rejected.

b. Check to assure that bolt is free from burrs and excessive wear especially around the hammer cam at the rear. Bolts with badly galled or noticeably worn cams must be rejected. Inspect firing pin tang slot for wear and burrs.

c. Inspect the firing pinhole at face of bolt. The corner should be free from burrs, but not rounded or chamfered.

d. Visually inspect to assure that there are no burred edges at the two cams on the operating lug.

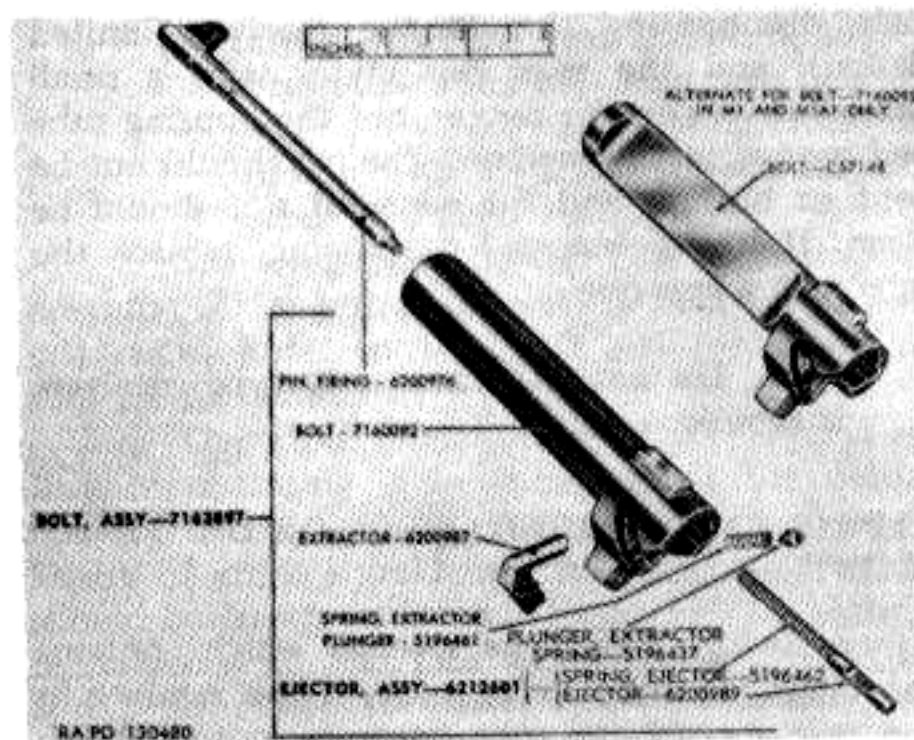

Figure 59. Bolt assembly.

e. Replace and dispose of all used extractor plunger springs during rebuild.

f. Extractors, with "V" type retaining notch or modified retaining notch, will be replaced and disposed of during rebuild. Use only new type plungers as shown in figure 58 and only previously unused plungers and plunger springs.

g. Visually inspect the ejector assembly for worn, deformed, or broken spring and for condition of ejector. Function test ejector.

h. Check to assure that only the new type of modified type firing pin (Fig. 61) is used. The old type pins can be modified by depot maintenance if the quantity involved warrants the work required to accomplish this (Fig. 62). Function test bolt and firing pin.

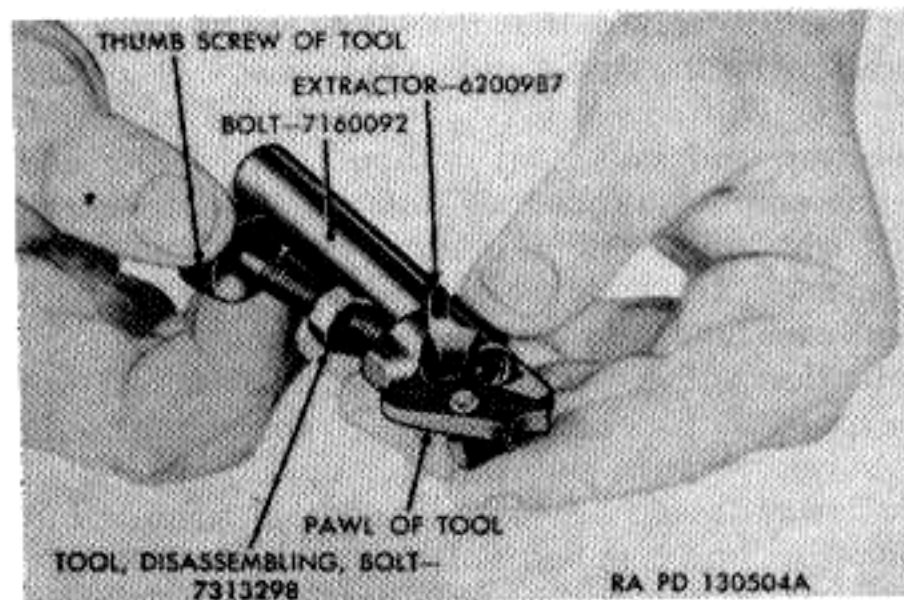

Figure 60. Disassembling bolt.

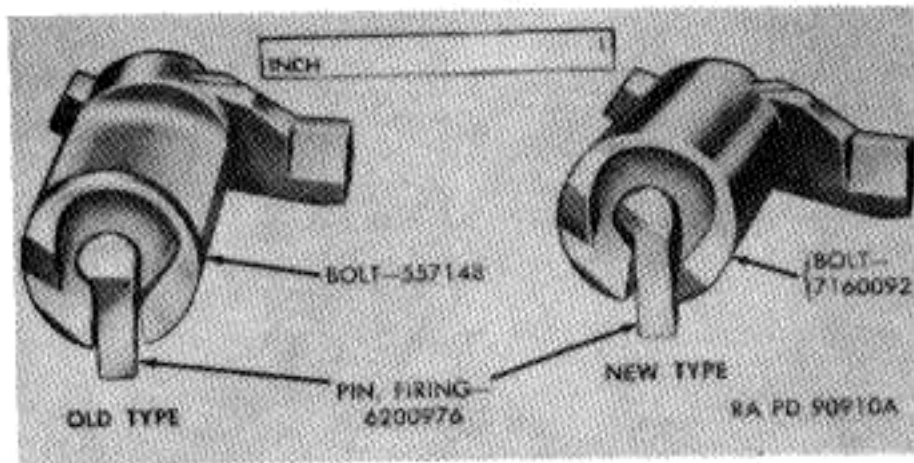

Figure 61. Bolt and firing pin.

i. Check to assure that only full round bolts 7160092 are used in the carbines M2 and M3 (Fig. 58). Bolt 557148 will be used in carbines M1 and M1A1 in so far as practicable in order to conserve supply of bolt 7160092 for use in the carbines M2 and M3.

j. Visually inspect to assure sufficient firing pin protrusion and proper contour of firing pin point. (The firing pin protrusion should not be less than 0.048 inch DEPOT MAINTENANCE ONLY.)

k. Check assembled bolt to insure that extractor shank does not protrude beyond body of bolt.

l. Repair and rebuild of the bolt group consists of replacing worn or damaged parts. Bolt faces and other parts subjected to burned powder residues must be thoroughly cleaned. Scrub these parts with a bristle brush moistened with rifle-bore cleaner.

### ASSEMBLY

a. Insert ejector and ejector spring so that recess in ejector, when it is depressed, will line up with inside surface of the bolt to permit complete entry of the extractor.

b. Insert extractor spring and plunger. Position the plunger so that its flat surface will match the inner flat surface of the extractor retaining lip.

c. Place bolt disassembling tool 7313298 on bolt (Fig. 60) so that slotted tang of its pawl rests on extractor plunger. (The bolt disassembling tool 7313298 is supplied to organization personnel and ordnance field and depot maintenance personnel.) Turn thumbscrew of tool until plunger is depressed; at the same time, the ejector is depressed into bolt by the tool.

d. Insert firing pin and extractor and remove tool.

### FUNCTIONAL CHECK

a. Test bolt for freedom of movement in its guideways in receiver. Check freedom of movement of firing pin in bolt, fit of tang in slot, and protrusion of nose of pin from face of bolt when in forward position. Firing pin should move freely in bolt.

b. Check functioning of extractor and ejector. Ejector should return forcibly from depressed position. When ejector is depressed, it should not extend beyond front lip of bolt because it is likely to cause interference with feeding.

### SECTION VII. FRONT SIGHT ASSEMBLY

#### DISASSEMBLY (DEPOT MAINTENANCE ONLY)

a. Do not remove front sight unless necessary, as the body of the front sight is crimped over both ends of the front sight pin, and front sight key is staked at the rear end in its keyway in the barrel. When original finish is reasonably satisfactory, the removal of front and rear sights and front band to permit sand blasting, in order to obtain the highest quality protective finish, is not required.

b. Remove the front sight as follows:

- (1) With the barrel and receiver in a padded vise, the muzzle protruding about 1 inch beyond the jaws of the vise, and the front sight vertical, drive out front sight pin from left to right, using a 3/32-inch drift.
- (2) Position front sight removing tool 7161237 over front sight, hooking it on the rear of the sight (Fig. 63).

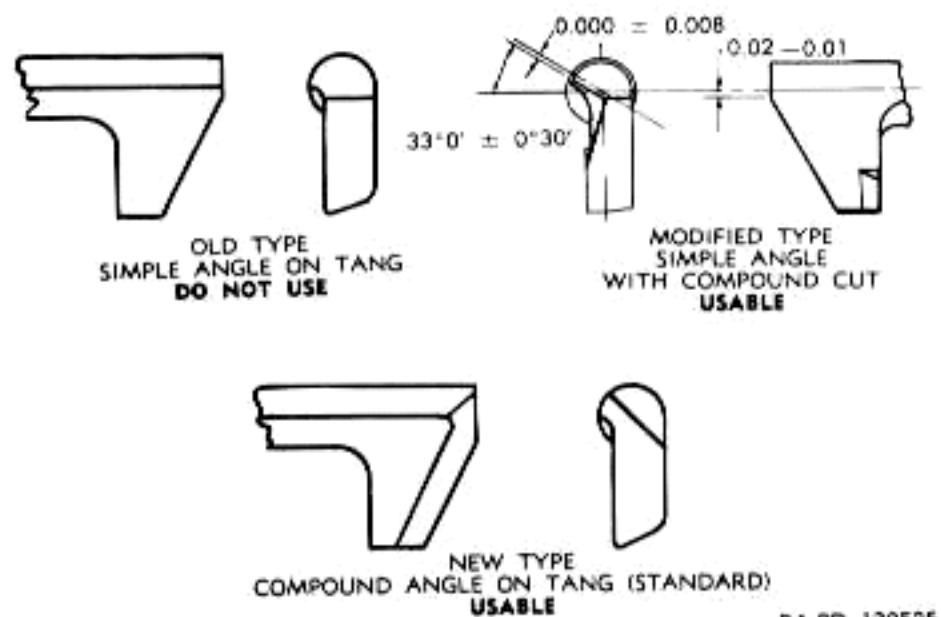

Figure 62. Firing pin 6200976.

## M1 CARBINE

- (3) Enter pilot of tool screw into end of barrel and remove front sight by turning handle of tool.

### INSPECTION

a. Check sight to see that it is tight on the barrel and free from malformation and burrs, and to assure that the barrel has been staked at the rear end of the front sight keyway. In any staking at this point, caution must be exercised to avoid distortion of the base. It is required that the front sight be tapped forward on the barrel to take up any clearance between the key, keyway, pin, and sight and that the metal of the barrel at the end of the keyway be upset against the key to secure the sight in this position.

b. Check to assure that staking of the front sight keyway and the application of the proof-mark have not distorted the bore.

c. Check to assure that the ring portion of the front band surrounds the barrel with spring tension.

d. Check crimping of front sight; it must be crimped at each end of the pinhole to prevent the pin from coming out.

e. Inspect wings; any deformation due to installation of sight on barrel or otherwise is cause for rejection.

f. Check height of blade; it must be not less than 0.140 inch, measured from the base of the blade. This is necessary for a good sight picture. In actual practice, it has been found necessary to maintain a height of approximately 0.315 inch in order to target by bore sighting. Sights, not conforming to this 0.315-inch dimension, will be retained for reworking.



Figure 63. Removing front sight.

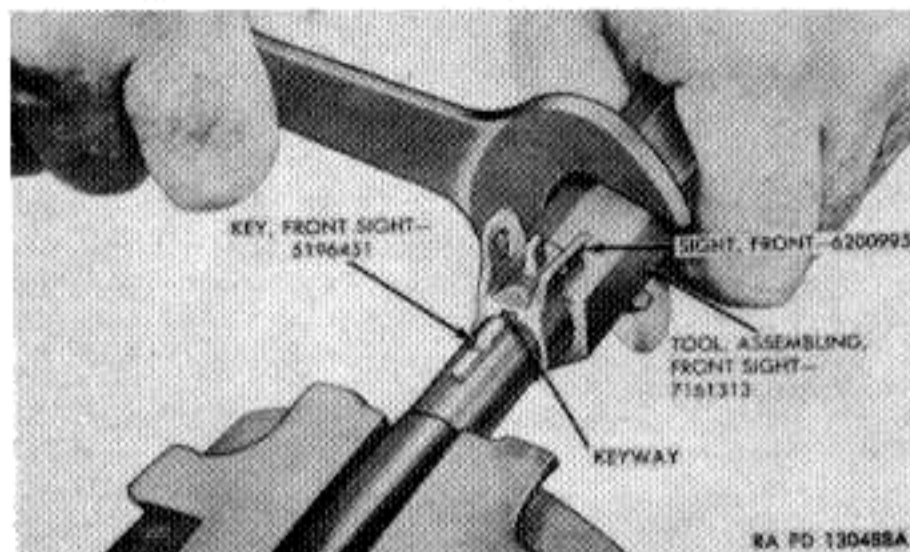

Figure 64. Aligning front sight.

g. The height of the blade is adjusted by depot maintenance so that the carbine will meet the targeting requirements defined on page 102. This is done by filing down the blade. The blade contains sufficient stock to adjust height during targeting.

h. Inspect the top of blade; it must be square and coated with Magic Blue (or similar substance) to prevent gloss and preserve the surface.

### REPAIR AND REBUILD

Looseness of the front sight on the barrel is usually caused by a loose key which is inadequately staked. The key can be tightened by tapping it forward against the front end of the keyway and then staking the rear end of the keyway firmly against the rear end of the key. Care must be taken not to distort the base. If the key has side movement, replace the key or, field maintenance maypeen the key lightly if a new key is not available.

### ASSEMBLY

*Caution:* The front band must be assembled on the barrel before the front sight is assembled.

Place front sight key in keyway in top of barrel at muzzle with pin notch facing up. Tap key snugly toward front end of keyway and stake metal of sight over both ends of pin to hold it in position. Slide front sight on barrel with sloping faces of wings to rear. Using front sight assembling tool 716313 mate keyway and key in barrel (Fig. 64) and drive sight on barrel (Fig. 65) until pinhole in sights is in alignment with pin notch in key. Install front sight pin and stake metal of sight over both ends of pin to hold it in position.



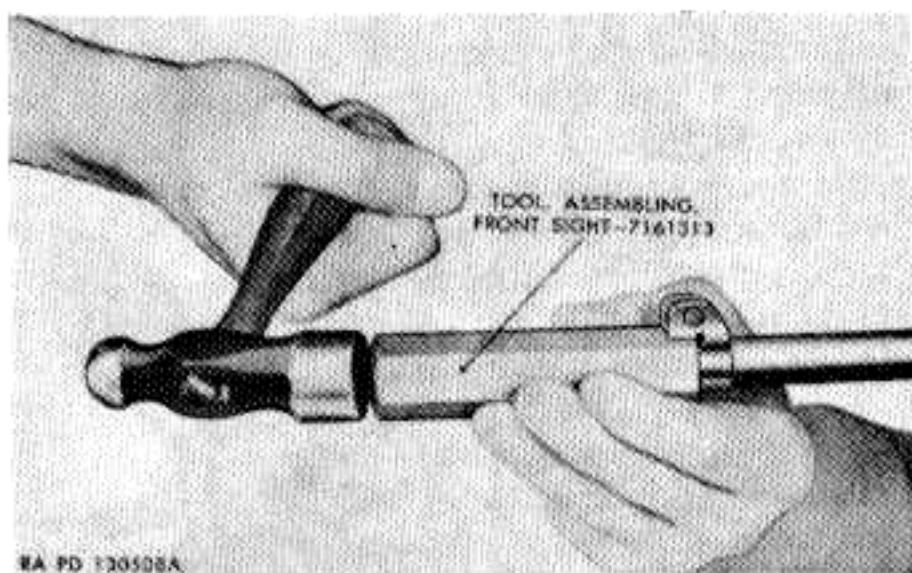

Figure 65. Installing front sight.

Drive sight forward and stake barrel against rear end of key.

Note. If practicable, the front sight will be kept mated with the barrel and receiver assembly from which it was removed.

## SECTION VIII. REAR SIGHT ASSEMBLY

### GENERAL

Carbines of early manufacture were equipped with an "L" type (leaf type) rear sight (Fig. 66) composed of two integral leaves set at right angles to each other. By Modification Work Order ORD B28-W3 this sight is replaced by the adjustable rear sight. All carbines of later manufacture are equipped with adjustable rear sight 6573955 or 7160060 (Fig. 67), which differ only in method of manufacture. Sight 6573955 is a machined type, and sight 7160060 is a stamped type. The function and operation of both sights are identical.

### DISASSEMBLY (FIELD MAINTENANCE)

a. Scribe a mark on the receiver directly opposite line on sight base for sight assembly 6573955 (machined type) and in the receiver directly opposite mark on zero sight plate for sight assembly 7160060 (stamped type). This is necessary for proper alignment in assembly.

b. Place adjustable rear sight assembling tool 7312068 on the receiver with the lip of the tool riding on the operating slide guideway in the receiver. If the sight is of the stamped type, insert spacer (Fig. 69) (hanging at end of chain on tool) in place to prevent distortion of sight base wings. With the right hand jack screw retracted to the

extreme position and out of the way, slide the tool over the sight (Fig. 68).

c. Push guide of tool (sliding member to which chain is attached), so that inside end rests on side wing of sight base, fit recess of connector over outside end of guide and tighten left hand jack screw. As pressure is applied, tap connector with a brass hammer and take up slack with jack screw until sight is removed.

### INSPECTION

a. Check sight base for looseness and sides of base will not be bent or distorted; damage of this nature may be caused by assembling and disassembling. Check ramp for worn or burred guideways and index ball retention notches on the floor of the sight ramp.

b. Check windage screw for wear of threads, burrs, security and staking, and check windage screw knob for worn knurling. The windage knob must be free enough for hand operation, move with distinct clicks, and retain its setting. It should be possible to move the ramp to extreme limit on either side without objectionable binding. With ramp centered in sight base, press windage knob to left and release to test spring action of index ball on knob. There should be merely lateral movement of the knob due to pressure and index spring action. When released, there should be clearance between inner face of knob and sight base.

c. With ramp centered in sight base, attempt to move lower end of ramp from side to side.

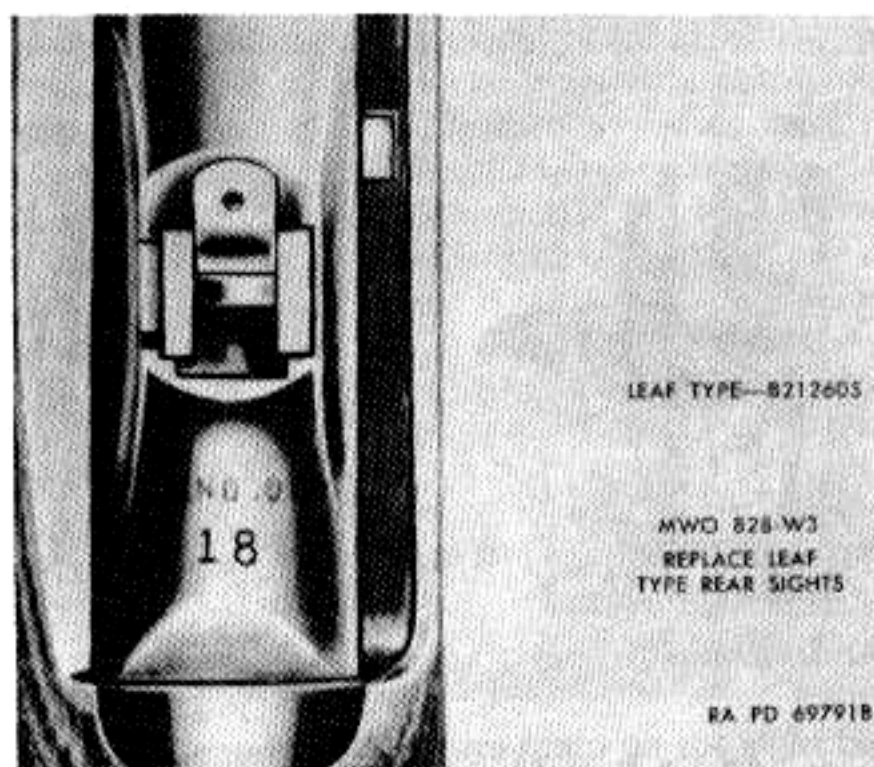

Figure 66. L-type (leaf type) rear sight assembly.

There should be practically no lateral movement. If movement is present, it indicates worn threads on either windage screw, ramp, or both. Press rear end of ramp down and release to check spring action of ramp guide plunger.

d. Move aperture slide up and down full length of ramp. Slide should move freely but with distinct clicks and be positively retained at each sight setting. The slide should be stopped at the front (lower) end of the ramp and at the rear (top). There should be no undue looseness of the aperture slide in the ramp guideways. Inspect peep hole for absence of shine and foreign matter.

e. On the stamped type sight, the index plate should be so positioned that the index line is in the approximate center of the base. (In other words, the index plate must not be rotated to one

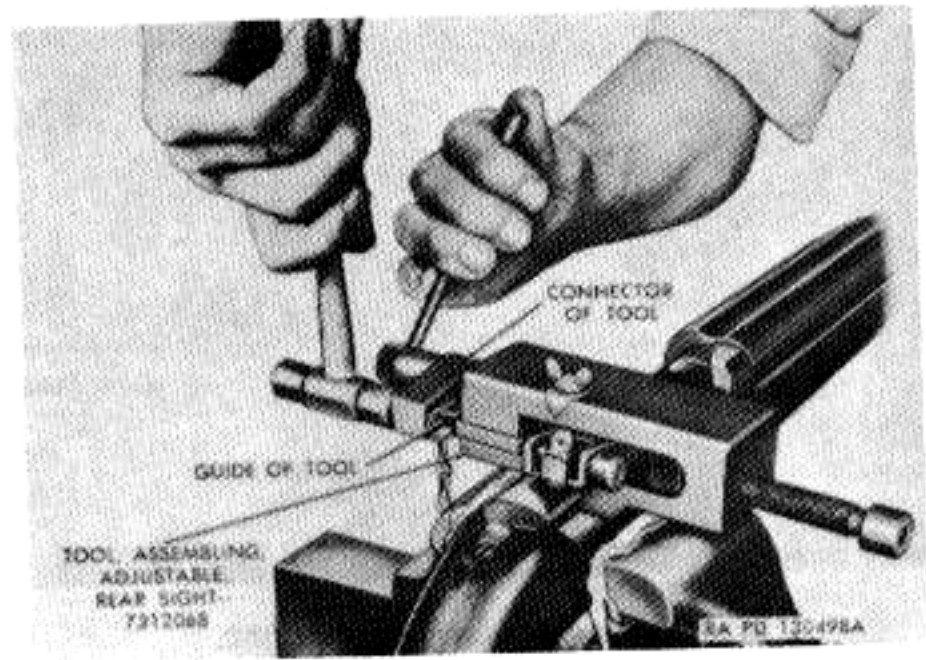

Figure 68. Removing adjustable rear sight.

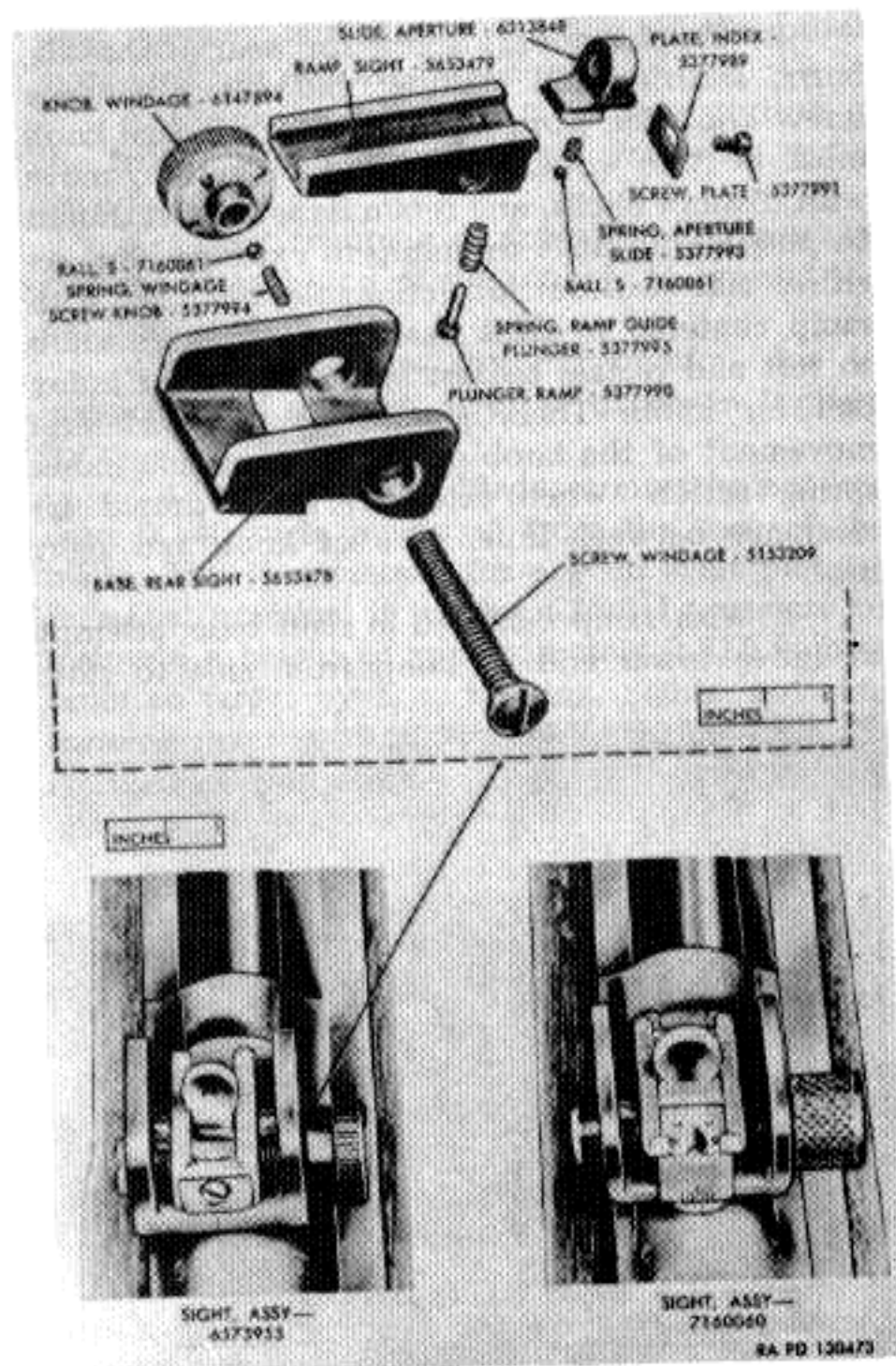

Figure 67. Adjustable rear sight assembly for M1, M1A1 and M2 carbines.

side or the other on its pivot because the full range of adjustment of the plate is intended for the user of the weapon.) The rivet should be tight enough to retain the plate firmly in its set position.

f. On the machined type sight, the index plate should be positioned approximately in the center of the ramp and the screw must be tight enough to retain the plate firmly in that position.

g. After targeting (DEPOT MAINTENANCE ONLY) and adjustment of the rear sight on the receiver, check to assure that the overhang of the rear sight base does not exceed the following limits:

- (1) The right-hand side of the sight base should not be pushed to the left beyond the point where it is flush with the side of the dovetail on the receiver.
- (2) The sight should be pushed onto the receiver far enough so that the left-hand side of the base is flush or beyond the left-hand side of the dovetail on the receiver.

h. After targeting, check to assure that the receiver is staked to retain the rear sight firmly in place.

## REPAIR AND REBUILD

a. *Repair.* As the adjustable rear sight is replaceable only as an assembly, no replacement spare parts are furnished for field repair. Check machined type sight for loose or missing index plate and screw. The sight should be kept clean and lightly oiled to prevent rusting and insure proper operation.

*b. Refinishing.* To remove corrosion from the rear sight assembly without removing it from the barrel and receiver assembly, proceed as follows:

- (1) Sand blast the adjustable rear sight assembly, when necessary, using fine grit and a controlled air pressure.
- (2) Blow accumulated grit and dust from the assembly with compressed air having a moisture filter.
- (3) Phosphate finish the assembly.
- (4) After finishing, thoroughly rinse, dry, and oil the assembly with water displacing oil.
- (5) Test rear sight ramp to determine that it traverses completely to left and right without binding.
- (6) Test aperture and it must move freely up and down the ramp under normal finger pressure.

*c. Cleaning.* The sight is cleaned best with a small brush and clean cloths. Remove light rust with preservative lubricating oil. Use crocus cloth for removal of heavy rust, but since its use produces shine, exercise caution. When cleaning, move ramp and aperture slide in order to clean thoroughly under them.

*d. Oiling.* Immediately after cleaning, apply a light film of preservative lubricating oil to all exposed metal surfaces to prevent rusting. Excess oil will collect foreign matter, which will clog the sight and cause excessive wear. A small drop of oil on index balls and ramp guide plunger will lubricate and preserve these parts and their component springs. Such oiling is best done with the dropper of the oiler, or a broom straw dipped in oil. Wipe off excess oil.

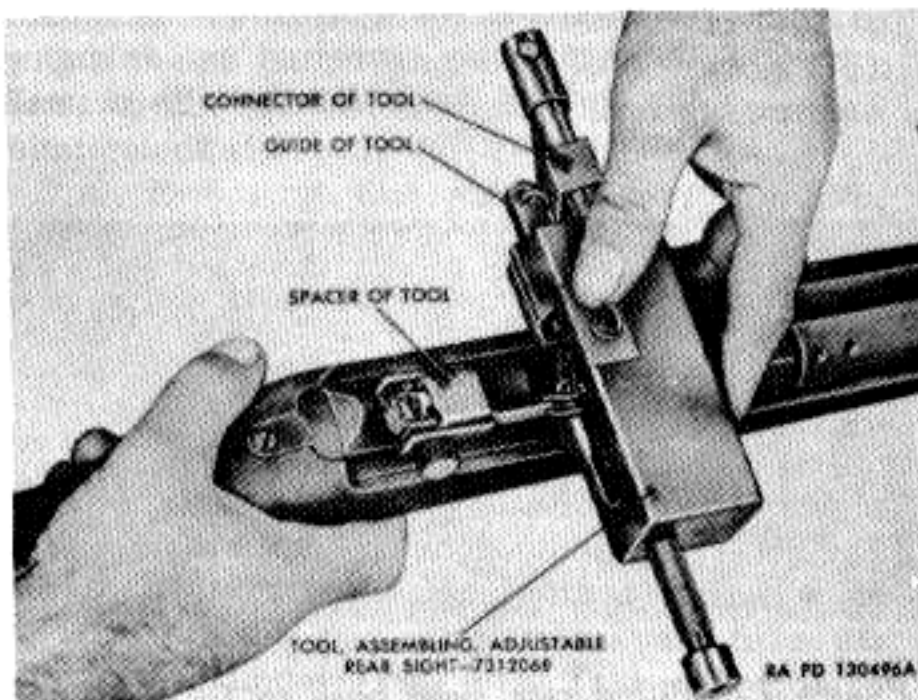

Figure 69. Rear sight assembling tool with spacer.

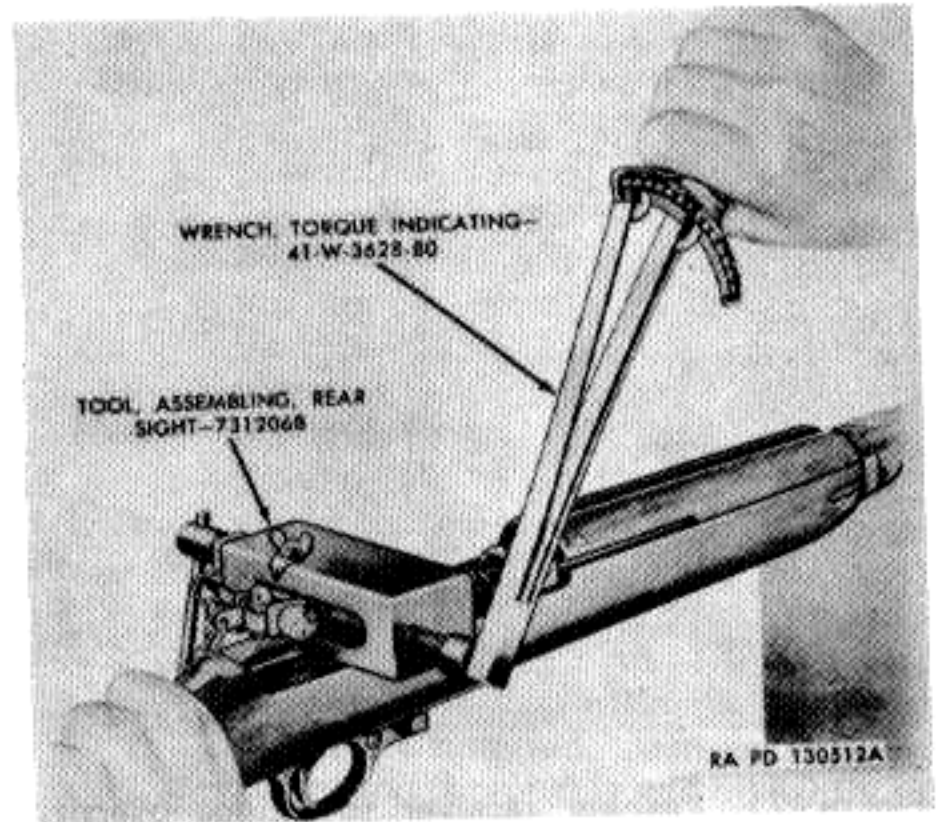

Figure 70. Moving rear sight in place with torque wrench.

Note. When cleaning the carbine, apply a small drop of oil to the aperture slide guideways in the ramp, the threads of the windage screw, the index balls, and ramp guide plunger. Use preservative lubricating oil (medium) above +32 degrees F. and in humid climates, and preservative lubricating oil (speical) below +32 degrees F.

*e. Loose Sight Base.* If the sight base becomes loose in the receiver, tighten it by restaking the receiver into either of the two notches in the dovetail base of the sight. If base has shifted, it should be realigned and restaked. If sight has been staked properly, it can be restaked in the same place. If necessary to restake at other than the previous points of staking, file new indents in sight base and stake receiver opposite the new indents. Make certain that points of staking are one-sixteenth of an inch from edges of dovetail slot and directly opposite the indents. If staking fixture does not line up with indents in sight base, perform staking free-handed as outlined above.

#### ASSEMBLY (FIELD MAINTENANCE)

- a. Press new rear sight into right side of dovetail by hand.
- b. Center the aperture ramp on the sight base.
- c. If stamped type sight is being placed on receiver, place spacer attached to assembling tool

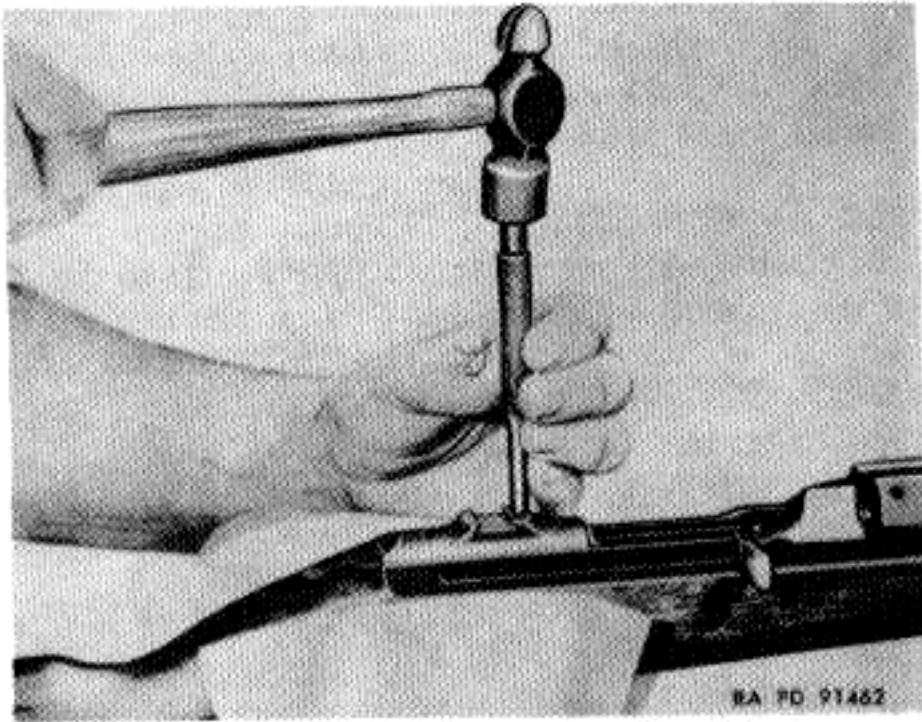

Figure 71. Peening receiver to reduce oversize dovetail slot.

7312068 in place for reinforcing the side wings of sight (Fig. 69).

d. Place assembling tool on receiver with lip of assembling tool engaging operating slide guide-way in receiver.

e. Move assembling tool to rear until dovetail guide (sliding member) on tool will enter dovetail slot in receiver.

f. Tighten right jack screw by hand until block of jack screw is against the side of sight.

g. Insert torque wrench 41-W-3628-85, and move the sight into the dovetail slot (Fig. 70). Wrench should show an applied torque reading of between 18 and 54 inch-pounds. If the reading is not within the above limits, remove sight and proceed as follows:

- (1) If reading is below 18 inch-pounds indent the area in front of the dovetail slot. This can first be done by using punch 7312234 (Fig. 73) and rapping punch with a hammer. Undertake this operation with extreme caution. A blow only hard enough to cause a flow of metal into the dovetail slot is necessary.
- (2) If reading is above 54 inch-pounds, file the bottom of the sight base as shown in figure 72. Do not attempt to file the edges of the sight base and under no circumstances should the receiver be filed.

*Caution:* Reading on torque wrench should be taken during movement of the wrench, as reading taken when starting the wrench will be high, due to starting torque in moving jack screw. Exercise great care during the procedure outlined in g above, as the dovetail base of the sight is hardened as well as the dovetail slot in the receiver. Because of this, it is necessary that the load limits as prescribed and as indicated on the torque wrench, be rigidly maintained. If too great a pressure is exerted in the placement of the sight, the receiver of the carbine will crack or break; and if too light a pressure is exerted, the sight will work loose under the shock of firing.

h. Continue operation above until zero line on sight base (machined type sight) or zero sight plate (stamped type sight) is aligned with scribe mark on rear of receiver.

- i. Remove the tool from the receiver.
- j. Screw ramp of sight to extreme left.
- k. Stake rear sight in place.

Note. The staking operation is extremely critical and success of this operation will depend largely upon the skill and judgment of the operation (Fig. 73). Bear in mind that the sharp upper edges of the dovetail slot on the receiver are easily chipped or cracked, and such damage will ultimately result in an unserviceable weapon. Many problems will arise which will have to be solved by the individual mechanic; a few of these problems and their remedies are listed in (1) and (2) below.

- (1) Indents on sight base dovetail may be horizontally misaligned with references to holes in sight base. If the indents are slightly out of horizontal alignment they may be corrected by enlarging the indents very slightly with a small three-square file.

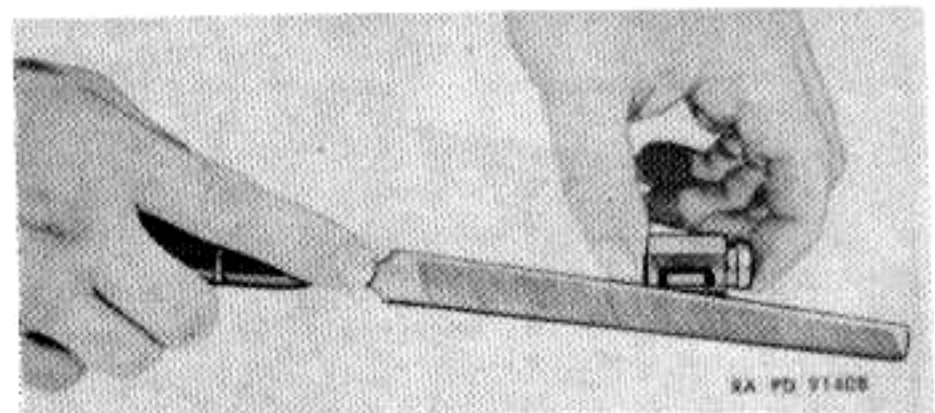

Figure 72. Filing rear sight base to fit undersize dovetail slot.

- (2) Sometimes sufficient material is not available on the receiver to permit an adequate staking job. This is particularly true when the sight is moved to one of its extreme positions. In this case, the procedure outlined in (1) above should be followed and new indents made to permit adequate staking.

*l.* On the machined type adjustable rear sight the index plate is held in place by a small screw. On some of these sights the screw is staked in such a manner as to prevent its removal. Take care, when zeroing the rifle by a movement of the index plate, to loosen the screw only enough to permit movement of the index plate.

*m.* The index plate on the stamped type sight is directly below the ramp and in the center rear portion of the sight base. Move this plate with a small drift to prevent damage to any of the components of the sight and weapon.

## SECTION IX. BARREL AND RECEIVER GROUP

### DISASSEMBLY

*a. Removing Barrel From Receiver (DEPOT MAINTENANCE ONLY).* Do not remove the barrel from the receiver except for replacement of a new barrel. Replace barrel if it is bent or damaged, if the chamber is worn to the extent of effecting excessive headspace or if it does not meet the requirements specified in table III. Completely disassemble all components from barrel and receiver. Place barrel in jaw protected vise. Allow enough of the rear end of the barrel to project from the vise to permit the wrench 7113308 to be positioned over front of receiver (Fig. 76). Place wrench over receiver near barrel and unscrew counterclockwise.

*b. Removing Gas Piston and Piston Nut (FIELD OR DEPOT MAINTENANCE).*

- (1) The gas piston and piston nut are the only removable parts of the gas cylinder group. To remove the piston, clamp the barrel firmly in a vise with protected jaws, and using gas piston nut removing tool M5 5621065 or gas cylinder reconditioning tool 7160995 (with wrench component), unscrew the piston nut counterclockwise from gas cylinder (Fig. 77). Take care not to bur or twist prongs on nut when

removing (nut is staked in place) or piston will not move freely. Remove nut, elevate muzzle of barrel, and slide piston out of gas cylinder. If necessary, tap cylinder lightly with a wooden block to slide piston out. If nut does not loosen readily, soak with preservative lubricating oil, special, for about an hour to loosen. Oil can be dropped through gas port drill hole in gas cylinder.

- (2) If piston becomes "frozen" in the gas cylinder due to carbon or rust, soak with preservative lubricating oil (special) for about an hour and then work out of cylinder. When the nut and piston are removed, clean gas cylinder and piston thoroughly and oil lightly.

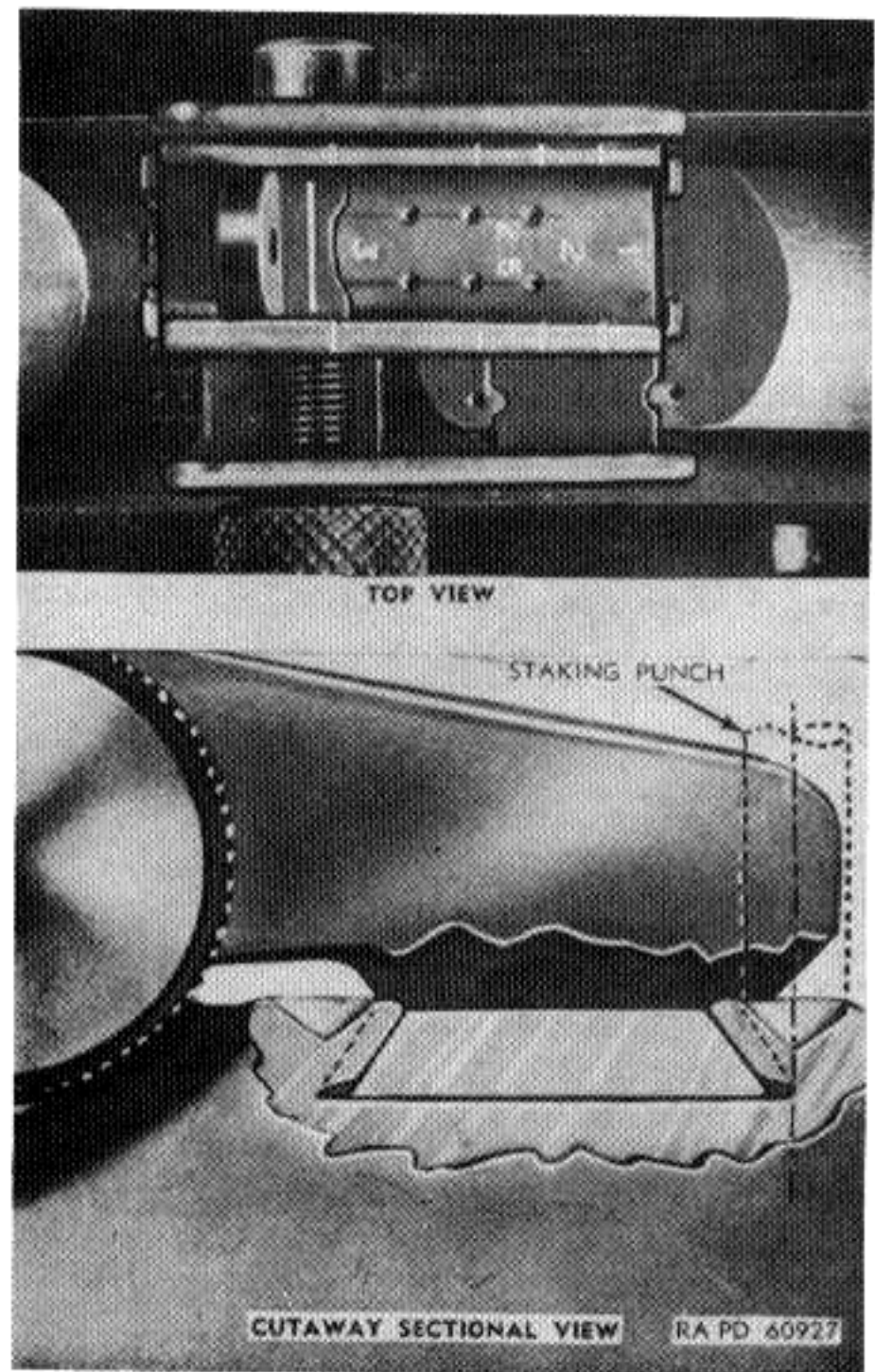

Figure 73. Rear sight showing staking.

## M1 CARBINE

- (3) The gas cylinder may be integral with the barrel, or swaged on the barrel at manufacture. Do not remove the gas cylinder. If gas cylinder is unserviceable, barrel assembly should be replaced (DEPOT MAINTENANCE ONLY).

### INSPECTION

#### a. Receiver (Figs. 74 and 75).

- (1) Inspect operating slide spring well for rust or foreign matter. Visually inspect receiver for break-through of the operating slide spring hole. This break-through occurred in the original manufacture of some receivers because of the drill running out through either the bottom or right-hand exterior surfaces. If the forward end of the break-through is 3 inches or more from the front end of the receiver, it is acceptable; otherwise, it must be rejected (DEPOT MAINTENANCE ONLY). Any sharp or feather edges around this break-through are to be removed.

- (2) Inspect receiver under "black light" (Magnaglo or approved equal) for cracks in the area around the bolt locking slot at the right hand side and at the front and rear trigger housing retaining lugs (DEPOT MAINTENANCE ONLY). Receivers having cracks extending in both directions around a corner must be rejected.
- (3) Visually inspect condition of firing pin retracting cam mating cut in the bridge of receiver (Fig. 78). This cam was cut to an angle of 33 degrees in the earlier manufacture of receivers and later to 45 degrees. Both are acceptable if in good condition.
- (4) Visually inspect trigger housing retaining pinhole in the receiver. If out-of-roundness is apparent, reject the receiver (DEPOT MAINTENANCE ONLY).
- (5) Inspect the bullet ramp in the receiver to assure it is clean and smooth for proper feeding of the ammunition. Burrs and sharp edges should be removed by careful polishing with fine emery cloth. The lower edge of the

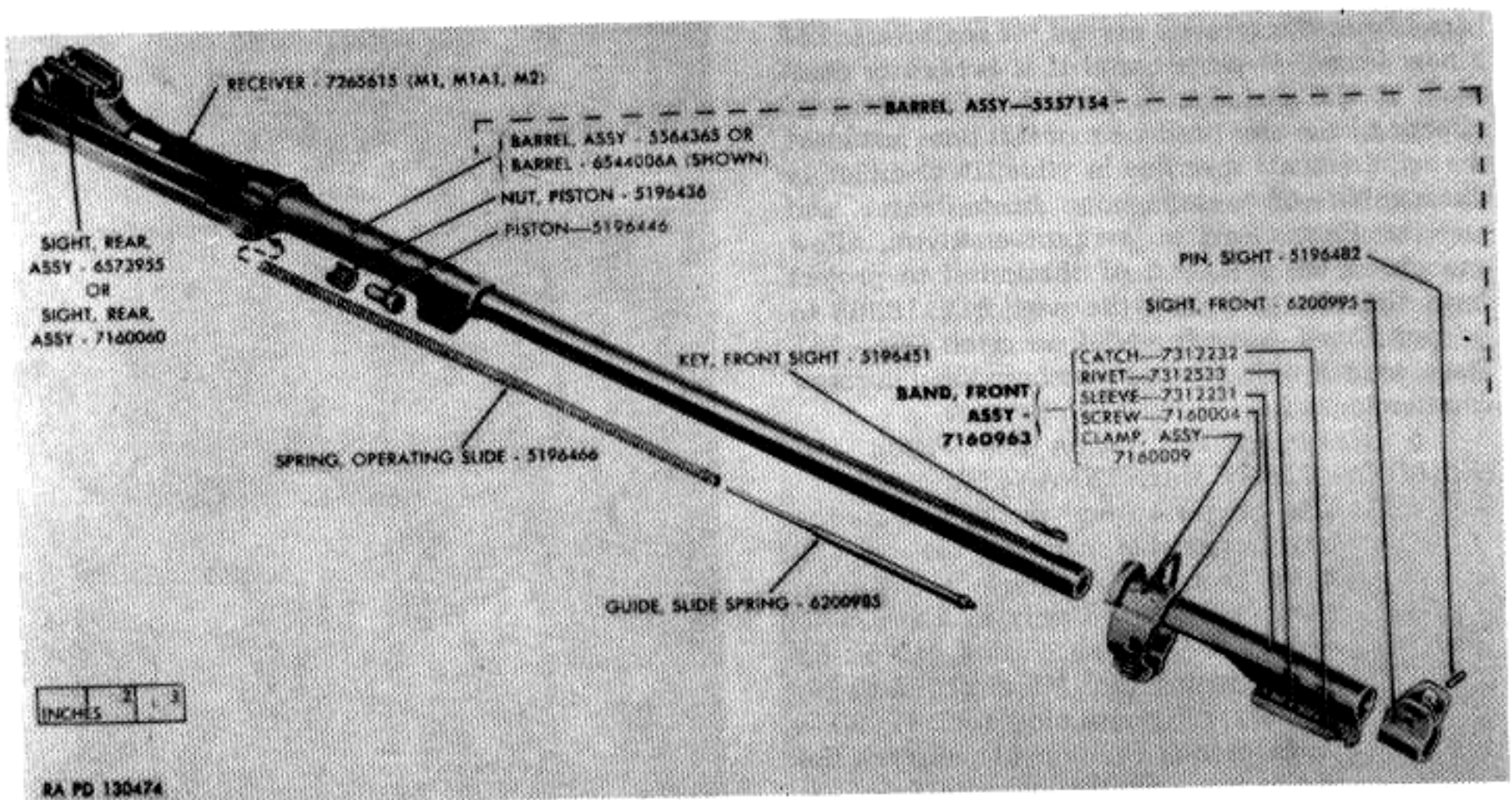

Figure 74. Barrel and receiver group M1, M1A1, M2 carbines.

## M1 CARBINE

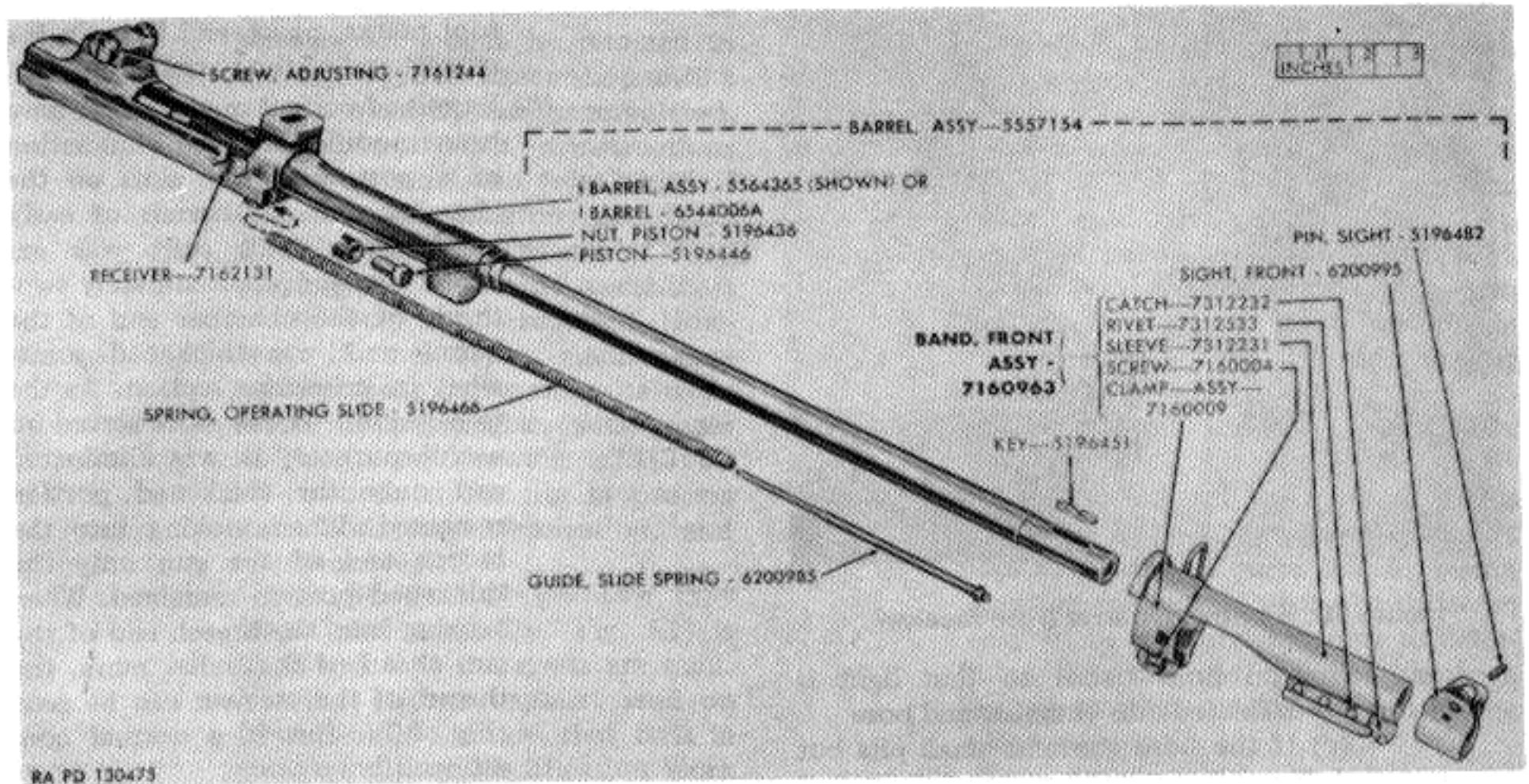

Figure 75. Barrel and receiver group M3 carbine.

bullet ramp (where the angular surface intersects the vertical) should be smoothly rounded.

- (6) Inspect receiver for looseness with barrel, deformation, rust and burrs. If receiver is disassembled from barrel, inspect for worn or crossed threads in barrel aperture (DEPOT MAINTENANCE ONLY).
- (7) Inspect bolt guideway and locking shoulders for wear, burrs, cracks, and foreign matter. Inspect receiver retaining lug on rear end (Figs. 78 and 104) for wear, burrs, and looseness with recoil plate when assembled to stock.
- (8) Inspect operating slide guideway on right side for wear, burrs, and foreign matter, and operating slide removal cut for wear and burrs. Inspect operating slide stop detent aperture for wear, burrs, and foreign matter. Forward surface of aperture should be at a sharp right angle to receiver, and with a clean edge to facilitate retention of stop, and rear face smooth and sloping to facilitate camming. Inspect the rear inside face of receiver for foreign matter.

### b. Barrel.

- (1) *General inspection.* Inspect barrel for deformation, alignment with receiver, and for rust, corrosion, and burrs. Inspect gas port for foreign matter and inspect extractor cut in rear face for burrs and foreign matter. Inspect operating slide guideways for excessive wear, burrs, and foreign matter. Burred or damaged muzzle end causes inaccuracy.
- (2) *Inspection for serviceability.*
  - (a) Inspection of barrel for serviceability is based principally upon accuracy, and inspectors are guided by this requirement. Accuracy is reduced in varying degrees by the following defects; bulges, erosion, and pits (table II). Before a barrel is inspected for serviceability, fouling and oil should be removed and the bore wiped dry.
  - (b) Place barrel reflector in the chamber and examine the bore from the muzzle and breech. If no barrel reflector is available, place a piece of white paper or rag in receiver

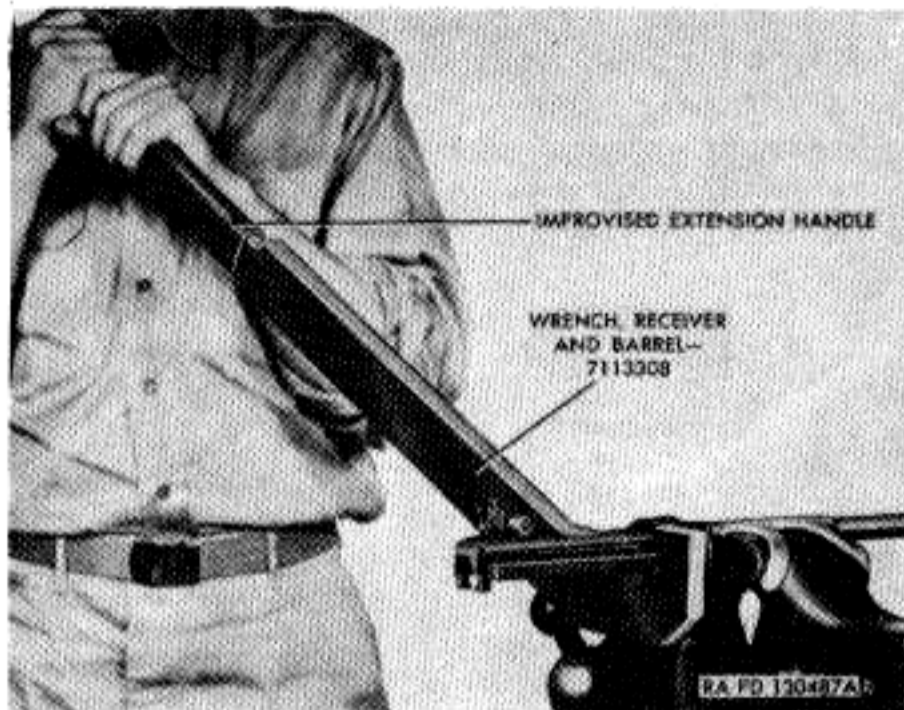

Figure 76. Removing barrel from receiver.

- and hold barrel so that light is reflected into chamber and bore.
- (c) If the bore contains small pits but has sharp and uniformly distinct lands, is free from bulges, and is not otherwise deformed, it is serviceable.
  - (d) If the barrel contains a bulge, it is unserviceable. This condition is indicated by a dark ring in the bore and may often be noticed through a bulge or raised ring on the barrel surface.
  - (e) If the barrel is pitted to such an extent that the sharpness of the lands is affected, or if it has a pit (or pits) which extends the width of a land or groove and is three-eighths inch long or longer, the barrel must be rejected.
  - (f) During the inspection of the bore from the breech, give special attention to the chamber. Pits will cause hard extraction and may cause the cartridge case to stick in the chamber sufficiently to cause failure to extract. Barrels with chambers having pits large enough to cause cartridges to stick are unserviceable.
  - (g) All rebuilt carbines must be counterbored at the muzzle end of the barrel (Fig. 79). This counterbore improves the accuracy of the carbine and is intended to eliminate

tool marks, nicks, and burrs in the muzzle end of the barrel.

- (h) Barrels of current manufacture have been modified by the elimination of a portion of the skirt on the chamber end. In barrels of early manufacture, this skirt was extended around approximately two-thirds of the chamber end of the barrel and was thickened somewhat in its center section. As the thin section of the skirt served no useful purpose, it was eliminated and only the thickened portion remained. When looking into the breech end of the gun only the thickened portion remained. When looking into the breech end of the gun ahead of the bullet ramp, the thread of the receiver can be seen (Fig. 80). This is a normal condition.
- (i) In well equipped establishments where it is practicable to perform barrel straightening operations, the barrels may be straightened if necessary to meet targeting requirements (DEPOT MAINTENANCE ONLY). Barrels that are rejected because they do not meet targeting

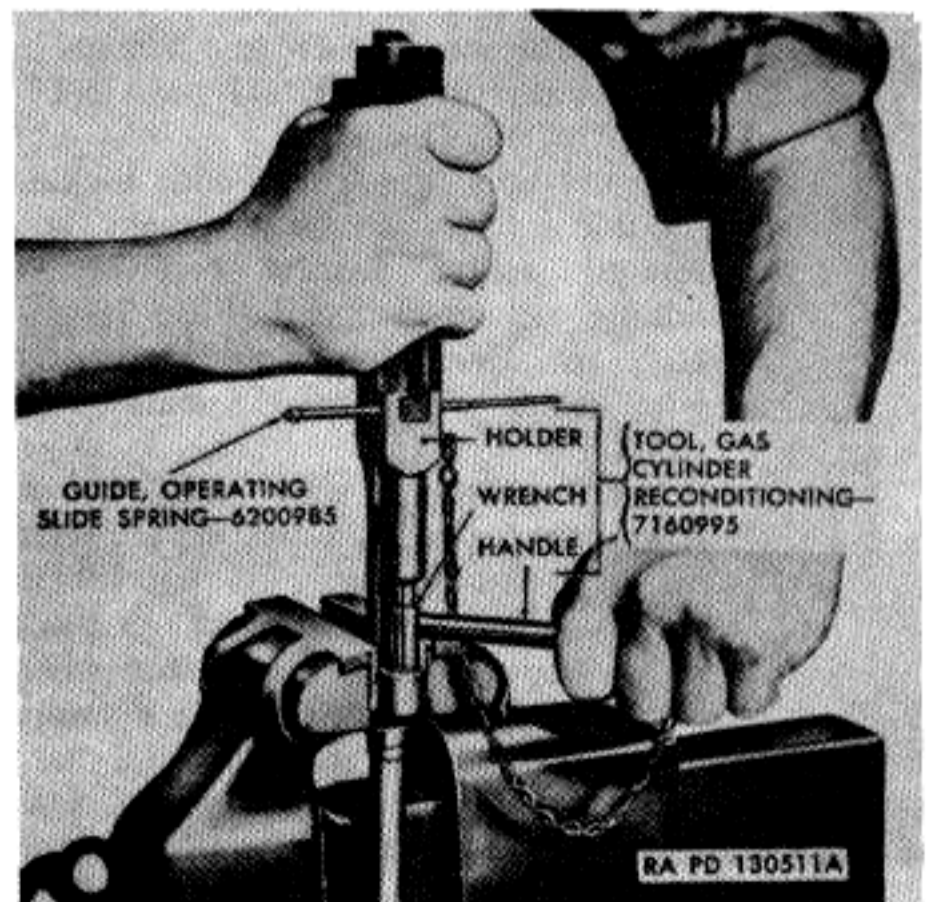

Figure 77. Removing piston nut from gas cylinder.



## M1 CARBINE

requirements but are otherwise serviceable, should be retained in the depot maintenance shop until a sizable quantity has accumulated, whereupon disposition instructions should be requested from Chief of Ordnance, Washington 25, D.C., ATTN: ORDFM. The use of drop plug gages to check the straightness of the bore is not required. However, if the depot maintenance establishment performing the work deems it practicable, such gages as shown on drawing B7317562 are authorized for use in process inspection, local fabrication, and maintenance.

- (j) Check to see that the new type front band assembly (Fig. 81) is used and that the rivets are tight. Visually inspect bayonet stud on front band to assure that it is in good condition. Modification Work Order ORD B28-W5 specifies that the old type front band assemblies must be replaced with the new type (Fig. 81) and describes the pro-

cedure. Check shape of front band swivel to assure that it swivels properly.

### c. Gas Cylinder Group.

- (1) Inspect the swaged-on type cylinder to assure that it is tightly swaged onto barrel, as determined by a hand test. Check all gas cylinders for deformation, piston wear, burrs, carbon, and rust, and check the gas port for foreign matter, using a 0.070-inch drill or plug inserted by hand.
- (2) Inspect piston for wear, burrs, and carbon.
- (3) Inspect piston nut for loose fit in gas cylinder. Inspect threads and turning lugs for wear and burrs. Inspect piston aperture for burrs. Piston should be an easy fit in aperture. Examine to determine that the gas cylinder has been staked very lightly into the nut in one place only.
- (4) Check carbines M2 and M3 to assure that only the counterbored piston nut is used. In the carbine M1 and M1A1, either the counterbored nut or the earlier type without the counterbore

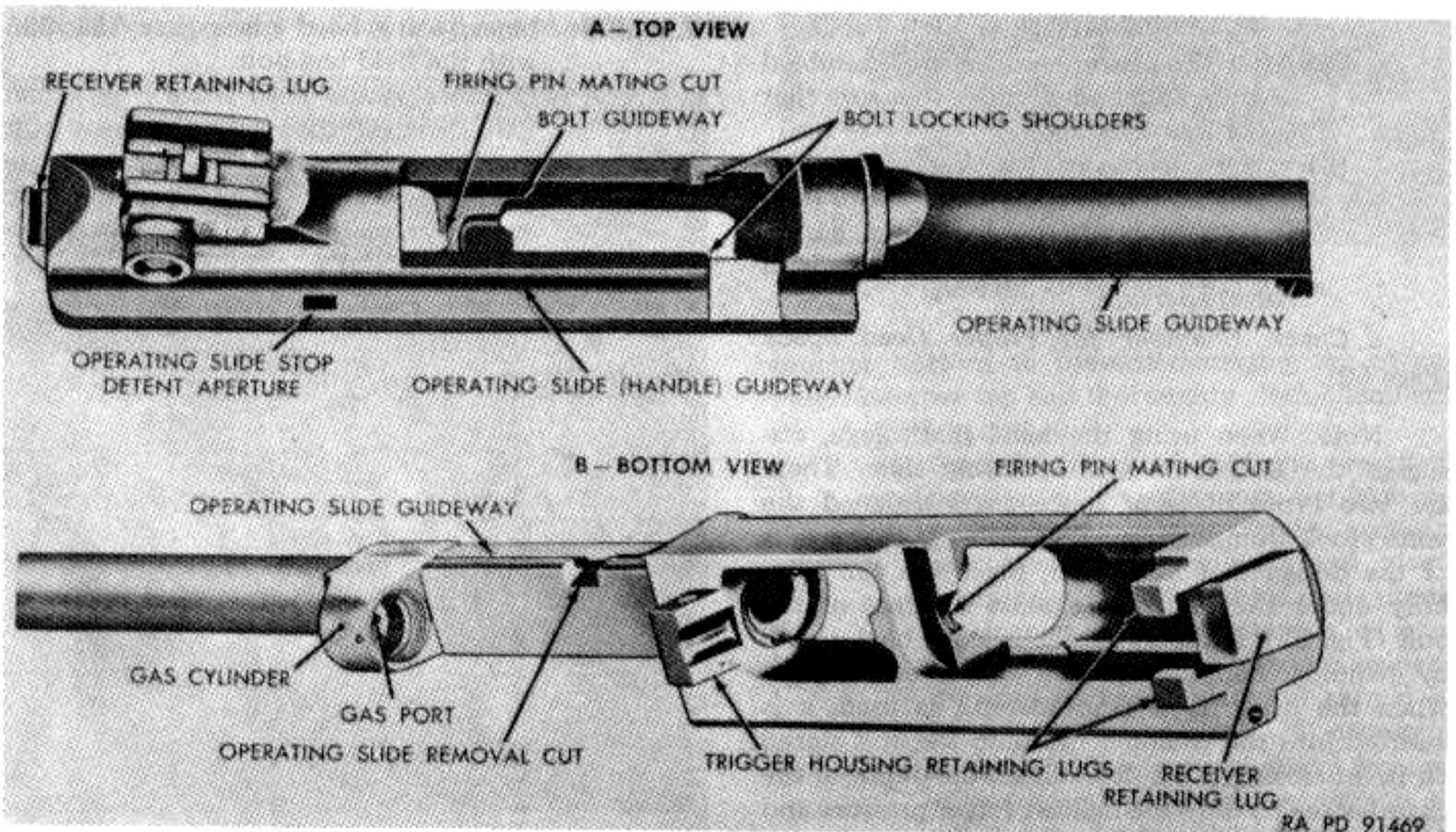

Figure 78. Barrel and receiver group — points of inspection.

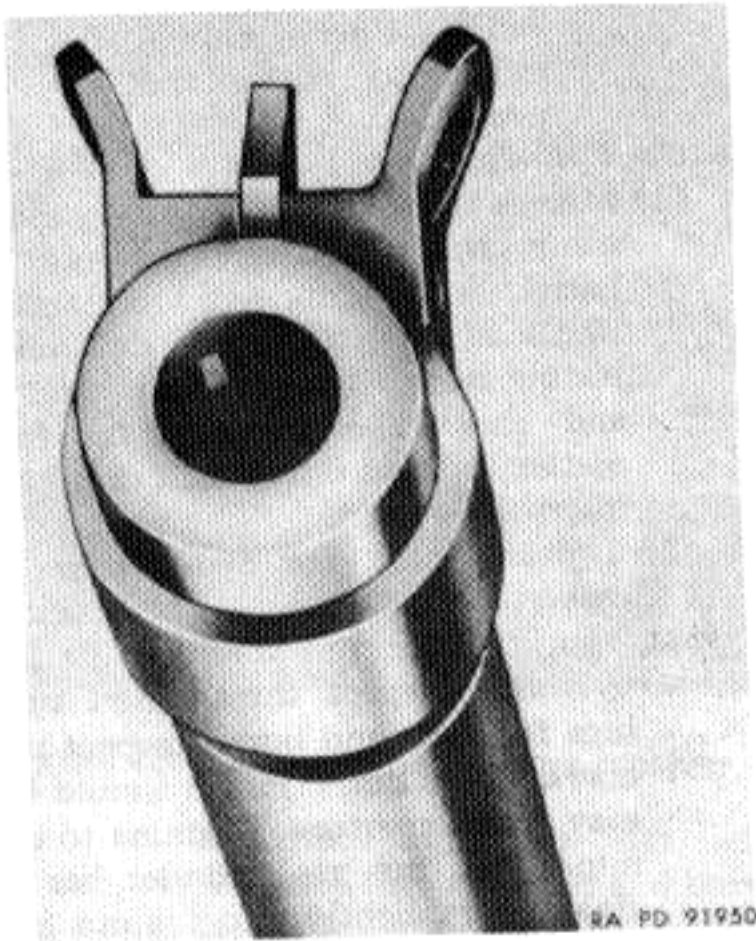

Figure 79. Muzzle end of barrel showing counterbore.

is usable; if a carbine lacks power with the uncounterbored nut, replace with a counterbored type (Fig. 43e).

- (5) After the piston and nut are assembled in the gas cylinder, check to assure that there is no binding.
- (6) Inspect receiver for looseness with barrel, deformation, rust, and burrs. If receiver is disassembled from barrel, inspect for worn or crossed threads in barrel aperture.

*d. Check Chamber for Proper Head Space*  
(Page 50).

Note. When using the head space gage, disengage the bolt from the operating slide. There are two types of head space gages assigned the same stock numbers for same sizes. If the gage is of the design that has a rim, place the rim carefully under the extractor against the face of the bolt (Fig. 83), if the extractor is assembled, thereby avoiding snapping the extractor over the gage. When the other type (shouldered), is used, it is inserted into the chamber first and the bolt closed on it. In closing the bolt to check the depth of the chamber, exert only the lightest finger pressure and make sure that the hammer does not exert pressure against the bolt.

- (1) Insert head space gage 7319934 (head space length 1.290 inches) into chamber, wide cylindrical end first, and close bolt. The bolt must close on the gage. With a new barrel, the bolt may not close on the gage without being forced. This is an indication that the head space is insufficient and the chamber must be reamed.
- (2) Insert head space gage 7319938 (head space length 1.298 inches). If the bolt closes without perceptible bite on the gage, the carbine is not acceptable for return to stock.
- (3) Field test bolt 7319932 (instead of carbine bolt) must close on head space gage 7319934 (head space length 1.290 inches). This is necessary to assure interchangeability. The field test bolt is dimensioned 0.560 inch from face to locking surface.
- (4) When the carbine is rebarreled (DEPOT MAINTENANCE ONLY), every effort must be made to hold the head space as close as possible to 1.290 inches, using the field test bolt. Under no circumstances should head space exceed 1.295 inches on rebarreled carbines, using head space gage 7319936 with the field test bolt.
- (5) Carbines whose head space is less than 1.302 inches, that is, component bolt does not close on head space gage 7319943 are acceptable for domestic and overseas use (FIELD MAINTENANCE ONLY).

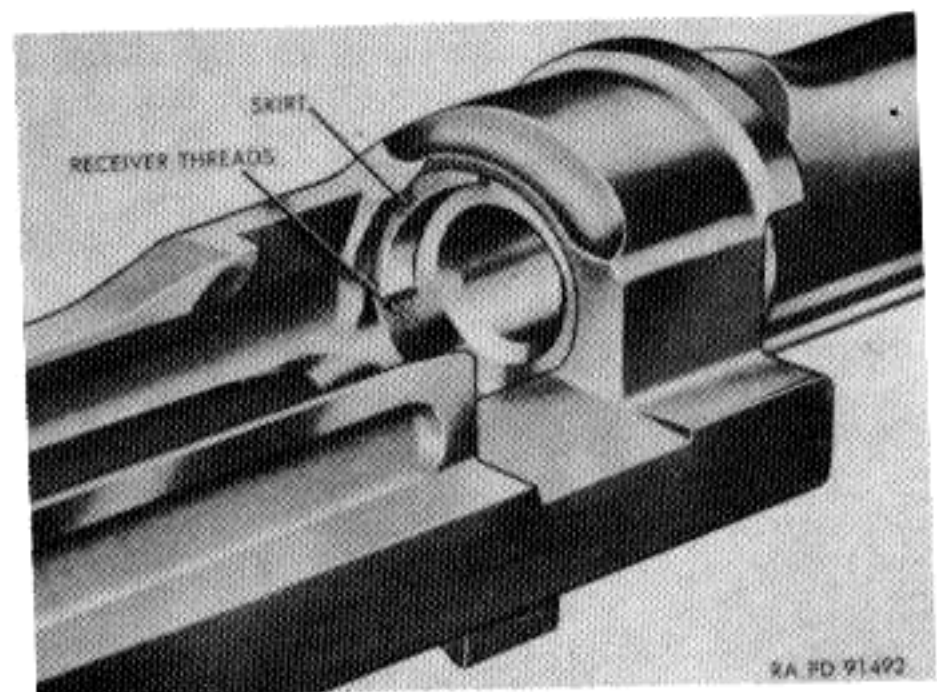

Figure 80. Breech and barrel showing new type skirt.

e. *Inspection After Assembly of Barrel and Receiver Group.* After assembly of the barrel and receiver group, perform the following inspections:

- (1) Check to assure that barrel has been staked at rear end of front sight.
- (2) Check to assure that staking the front sight keyway and the application of the proofmark have not distorted the bore.
- (3) Check front band screw to assure that head is in good condition and that it is staked or spun over sufficiently to prevent loss of screw.
- (4) Check to assure that the ring portion of the front band surrounds the barrel with spring tension and check the swivel to assure that it swivels properly.
- (5) Check to assure that the operating slide can be drawn all the way back to its stop against the receiver without binding.

## REPAIR AND REBUILD

a. *Chasing Gas Cylinder Thread.* Chase threads of the gas cylinder, using gas cylinder tap member of tool 7160995 (Fig. 83). Dip tap in a cutting oil and start tap carefully in gas cylinder. Cut threads a little at a time, using a forward and backward movement. Exercise care to stop tap as soon as it

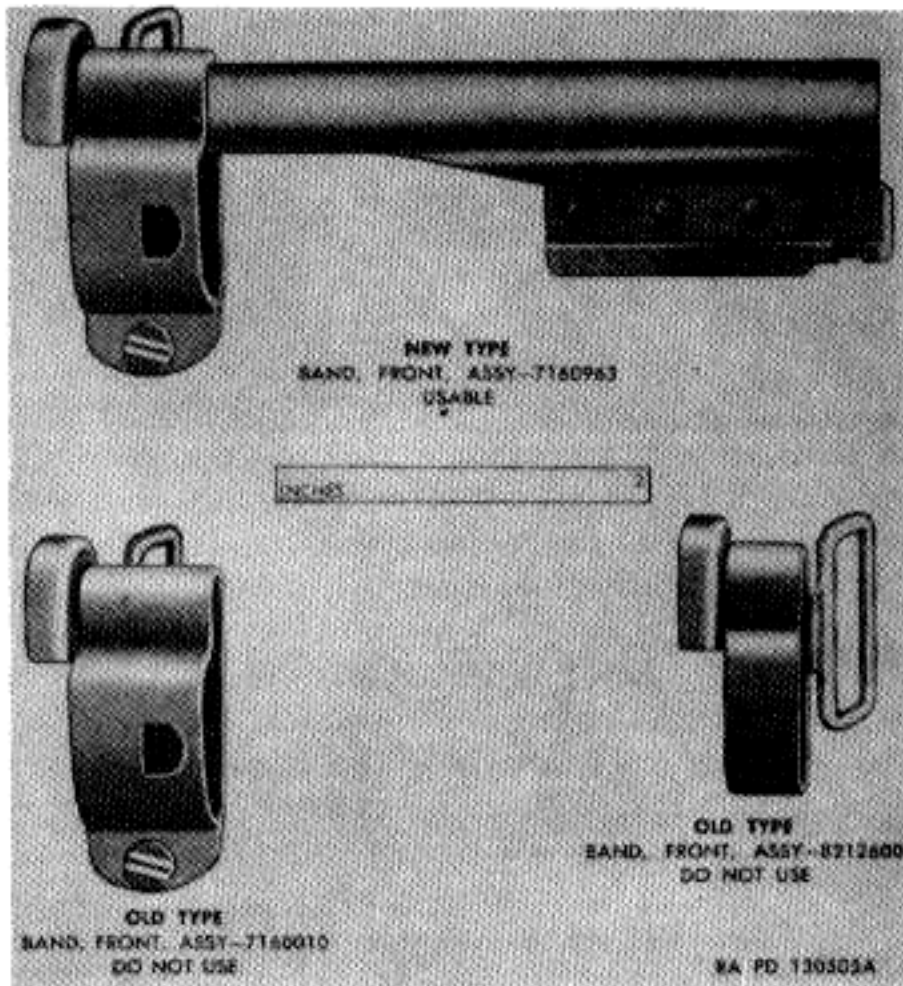

Figure 81. Front band assemblies.

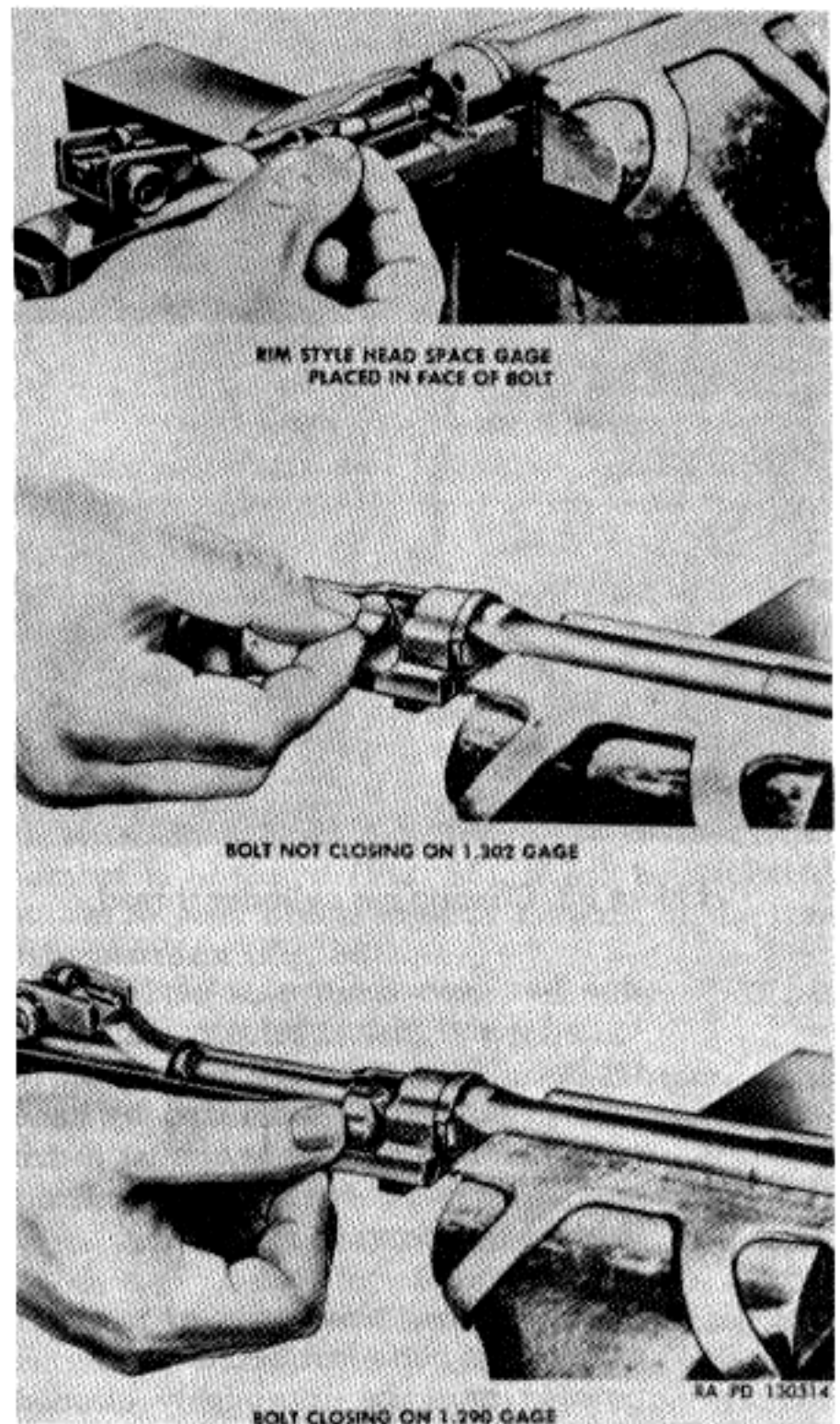

Figure 82. Checking head space.

touches bottom to prevent damaging tap or cylinder. Remove tap and thoroughly clean chamber.

b. *Carbon and Rust.*

- (1) *Carbon.* Because of the rearward position of the gas port and high gas pressure encountered there, excessive carbonization of cylinder and piston is unlikely. However, these parts should be cleaned at regular intervals, or when fouling or sticking of piston is evident; the gas port in the barrel should be inspected and cleaned if necessary. Remove piston nut and piston from gas cylinder and scrape excess carbon off with flat blade. Take care not to scratch parts unnecessarily. When car-

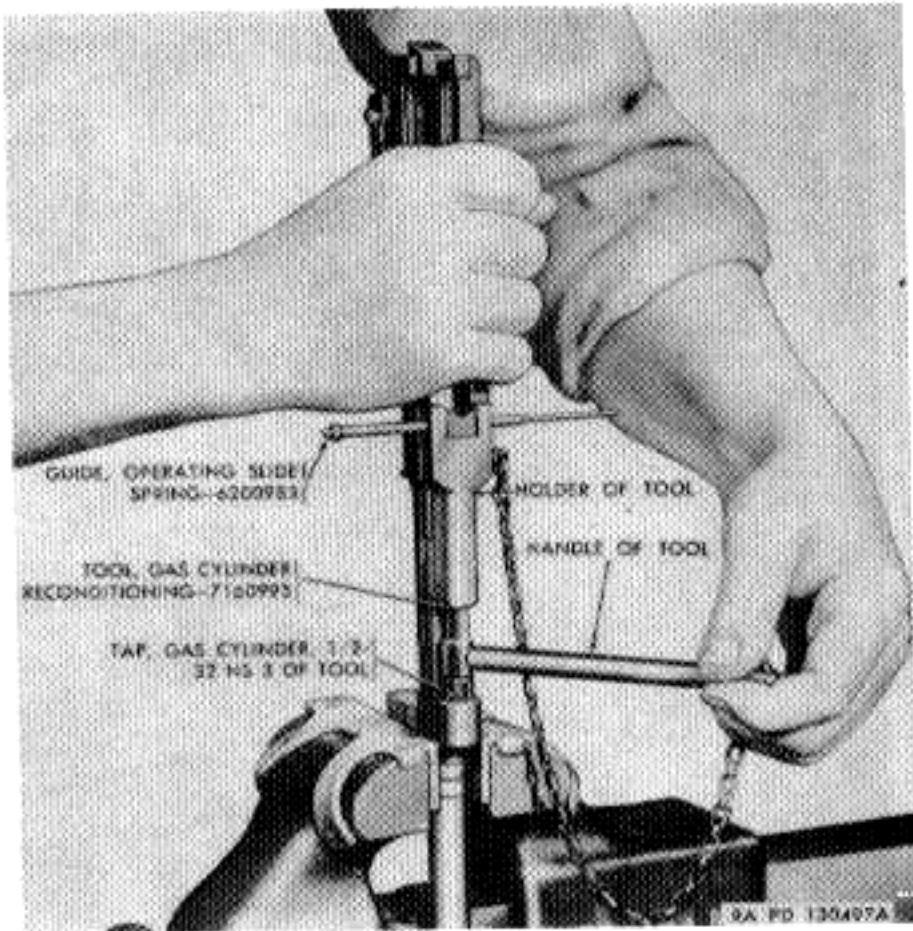

Figure 83. Chasing gas cylinder thread.

bon has been removed, clean inside of cylinder and piston, oil very lightly and replace. Clean gas port with an 0.070-inch or smaller drill inserted by hand, or with piece of wire or similar instrument. Be sure to stake piston nut lightly in place when assembling.

Note. Pistons, breech end of receivers, and other parts subjected to burned powder must be thoroughly cleaned. Scrub these parts with a bristle brush moistened with rifle-bore cleaner.

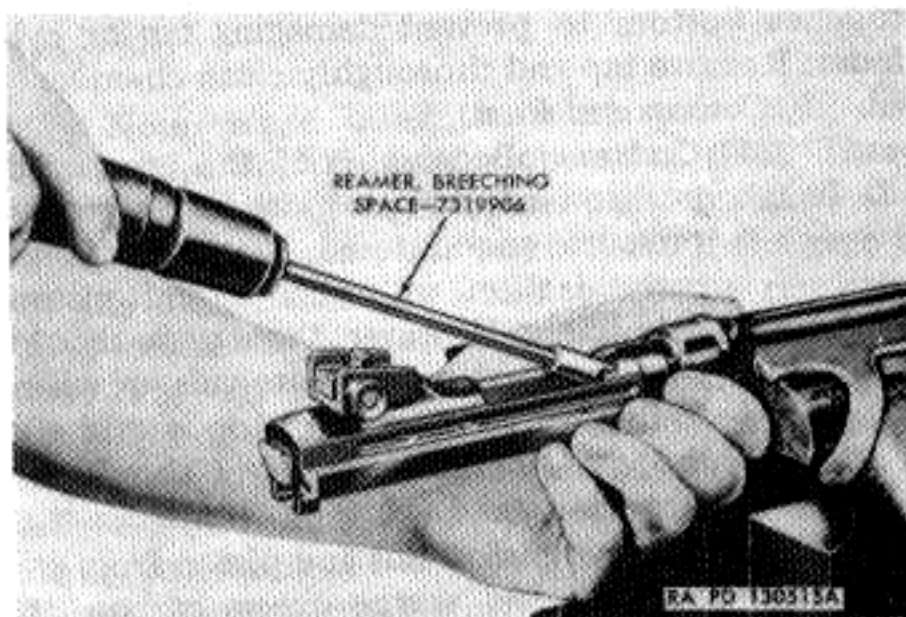

Figure 84. Reaming chamber for head space.

(2) *Rust*. Rust is more likely to form on surfaces not regularly lubricated, or where barrel head dissipates oil film rapidly. Such points are under side of barrel, body of oiler beneath sling, receiver locking lug recess in recoil plate, operating slide spring, well in receiver ("alternate" design receiver) or spring housing tube, rear sight base, inside faces of operating slide, recesses in trigger housing, and unexposed recesses and faces. Remove rust with a rag saturated with rifle-bore cleaner, preservative lubricating oil (special) or by using crocus cloth, but exercise care to avoid scratching surfaces. After rust is removed, wipe surface with clean, dry cloth and then with clean cloth lightly saturated with preservative lubricating oil (special). The operating slide spring housing (or tube) may be cleaned with the carbine cleaning rod

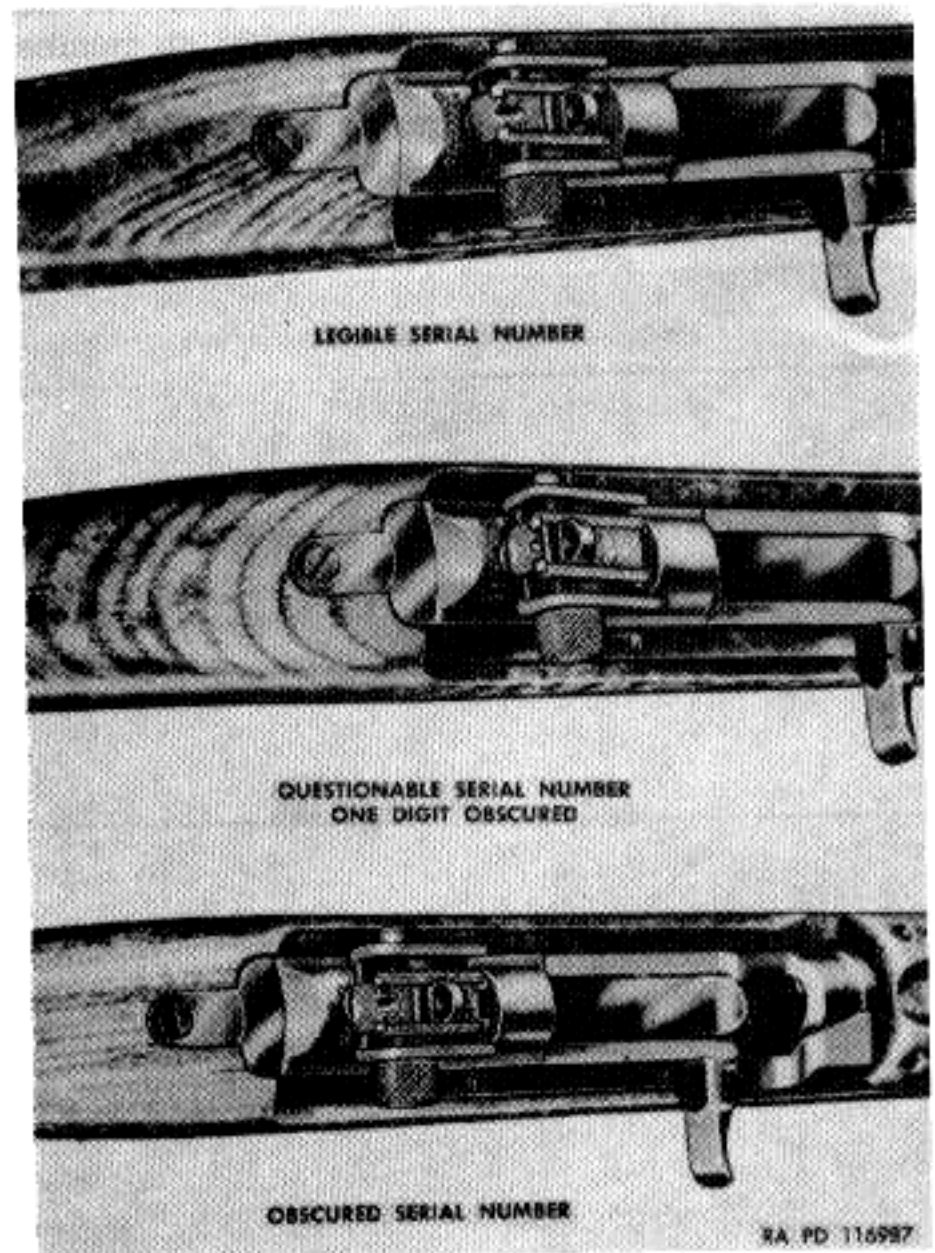

Figure 85. Serial numbers on cal. .30 carbines.

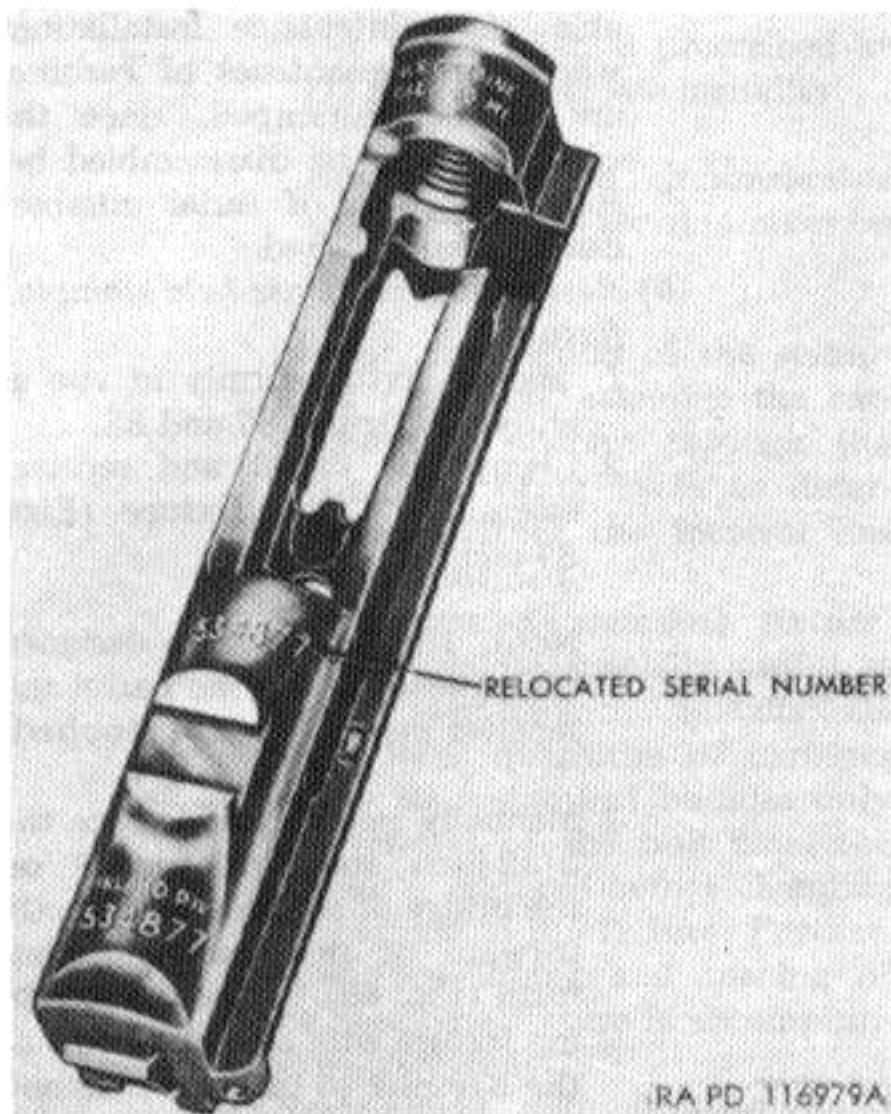

Figure 86. Relocated serial number on cal. .30 carbines.

and small patch. Be sure rear end of tube is clean.

*c. Refinishing of Barrel and Receiver.* When necessary to sand or grit blast to remove rust or otherwise prepare the barrel and receiver for refinishing, remove the rear sight and front band. If practicable, the front sight should be kept mated with the barrel and receiver assembly from which it is removed. When original finish is reasonably satisfactory, the removal of front and rear sights and the front band to permit sand blasting, in order to obtain the highest quality protective finish, is not required. During any refinishing of the barrel and receiver, the gas cylinder, muzzle, and breech end of the barrel must be plugged with corks to prevent solution from entering the bore or the cylinder portion of the gas cylinder. By drilling a 3/16-inch hole through the rear end of the receiver into the operating slide spring hole, good circulation of phosphating solutions and preservative compounds can be obtained.

*d. Reaming Chamber.*

- (1) Dip breeching space reamer 7319906 in lard oil and place in chamber through top opening of receiver (Fig. 84). Turn-

ing handle slowly to the right, remove only sufficient metal to permit bolt to close on head space gage 7319934 (head space length 1.290 inches).

- (2) Wash chips from reamer and chamber with lard oil after removing from chamber.
- (3) Handle reamer with care to prevent it from being chipped or picked. Never turn reamer backwards in chamber as this tends to dull the cutting edges.

*e. Restoring Serial Numbers (FIELD MAINTENANCE).* Serial numbers which have become obscured because of the installation of the adjustable rear sight must be restored. Since the degree of obscurity varies, this will be effected in one of two ways: (1) if the serial number is questionable (Fig. 85) (one digit obscured), use white graduation filler 52-F-100-230, listed in Department of the Army Supply Catalog ORD 3 SNLK-1, to improve the legibility; and (2) if the serial number is obscured (Fig. 85), it will be relocated on the receiver bridge directly forward of the rear sight platform (Fig. 86).

(1) *Questionable serial numbers (FIELD MAINTENANCE ONLY).*

- (a) Mask the adjustable rear sight to prevent filler from entering the sight.
- (b) Work a small quantity of filler into the serial number and allow it to dry for 5 minutes. Wipe off all excess filler with a clean rag and allow to dry for 3 hours.
- (c) In the event that the application of filler fails to restore the legibility of the serial number, relocation of

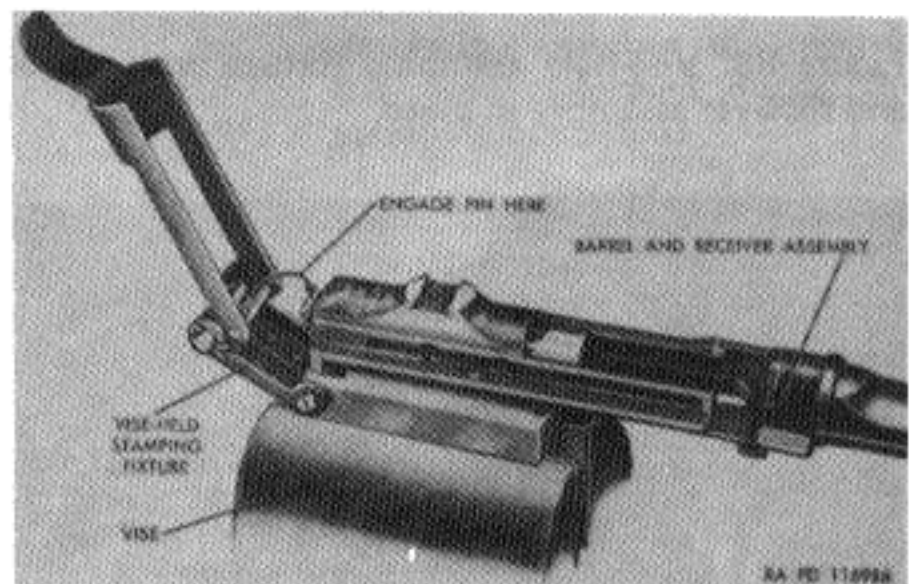

Figure 87. Placement of barrel and receiver assembly in vice-held stamping fixture.

the number by depot maintenance personnel is required.

(2) *Obscured serial numbers (DEPOT MAINTENANCE ONLY)*. Maintenance organizations engaged in restamping serial numbers will fabricate fixtures locally to reinforce and clamp the receiver during the stamping operation. Two fixtures have been developed for this purpose; the vise-held stamping fixture (Figs. 87 and 88) and the bench-mounted stamping fixture (Figs. 89 and 90). The choice of fixture which best suits the requirements of the maintenance organization is left to the discretion of that organization.

(a) *Vise-held stamping fixture*. This fixture is relatively simple to fabricate requires little space for storage, and may be quickly mounted in any vise. However, it is not adapt-

able at maintenance installations where large quantities of carbines are to be restamped, since the carbines must be disassembled before relocation of serial numbers can be accomplished.

(b) *Restamping with vise-held stamping fixture*.

1. Secure fixture firmly in vise as shown in figures 87 and 88.
2. Clamp the barrel and receiver assembly in the fixture (Figs. 87 and 88).

Note. The fixture is so designed that disassembling the barrel and receiver assembly is not required.

3. Manually position and space the 3/32-inch stamping fixture on the bridge of the receiver directly forward of the rear sight platform (Fig. 86). Strike the stamping fixture with one firm blow of the hammer to insure a neat and distinct impression. Repeat this procedure until all digits of serial number are transposed.

Note. The 3/32-inch stamping fixture is not included in the supply system and must be procured locally.

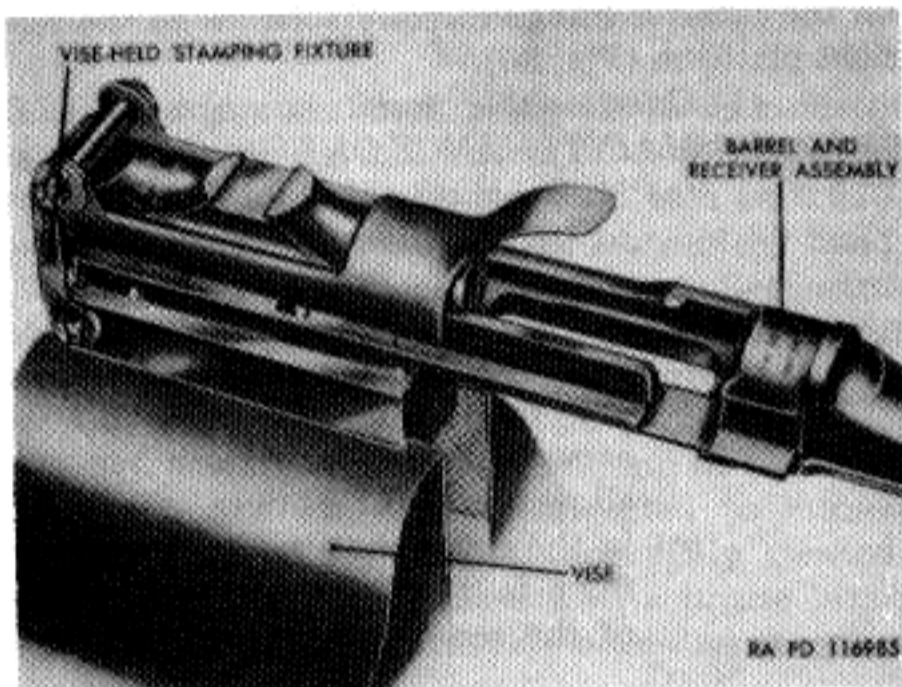

Figure 88. Vise-held stamping fixture with barrel and receiver assembly in place.

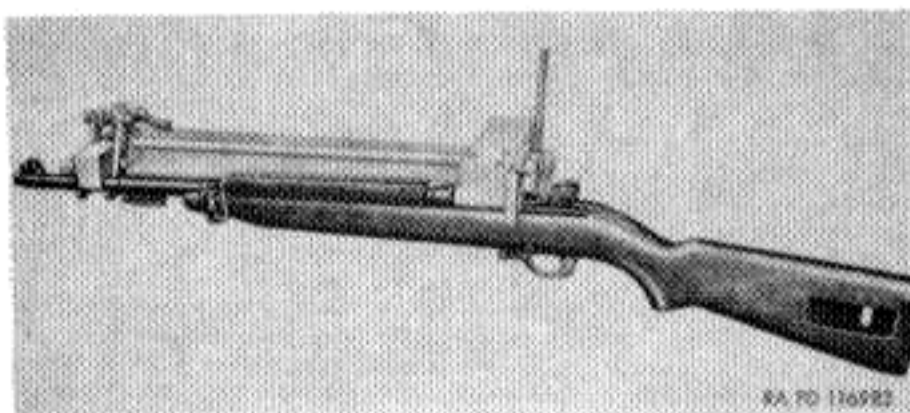

Figure 89. Carbine clamped in bench-mounted stamping fixture.

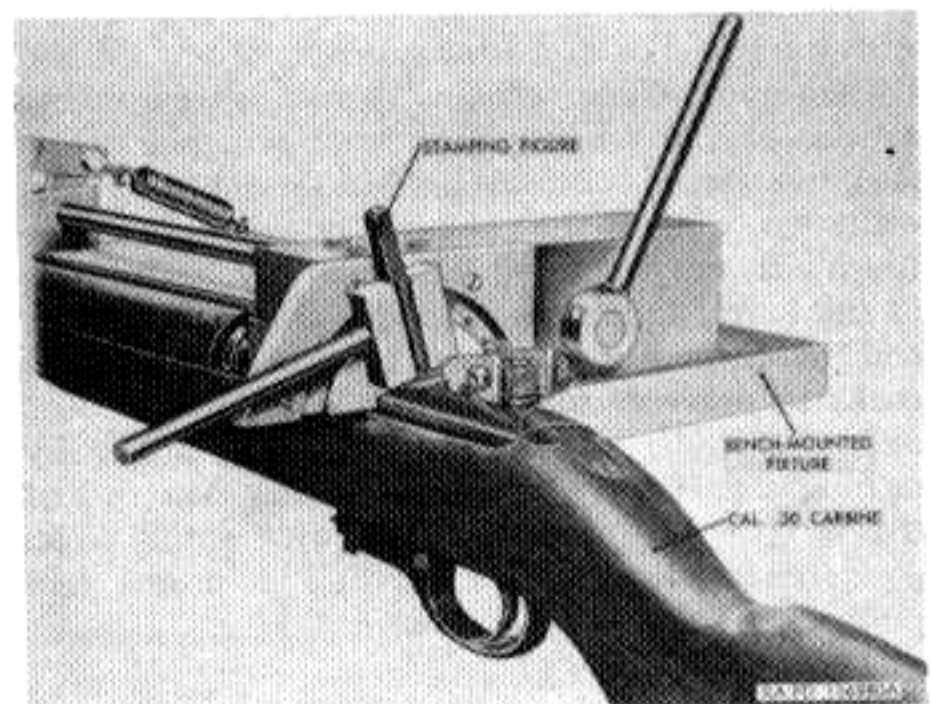

Figure 90. Bench-mounted stamping fixture with carbine and stamping figure in place.

## M1 CARBINE

4. Use white filler as prescribed in (1) above to increase legibility.

Note. Under no circumstances will the original serial number be obliterated.

5. Upon completion of the stamping operation, assemble the carbine and operate through the complete firing cycle to determine whether the receiver has been deformed.

(c) *Bench-mounted stamping fixture.*

This fixture is especially useful at depot maintenance installations where large quantities of carbines are to be restamped because only the removal of the bolt from the carbine is required before clamping the carbine in the fixture. Furthermore, positioning and spacing of the stamping fixture is accomplished mechanically.

(d) *Restamping with bench-mounted stamping fixture.*

1. Secure the fixture to the bench or table by inserting bolts through the holes, provided for this purpose, in the base of the fixture. Allow sufficient clearance for the unobstructed insertion of the carbine in the fixture.

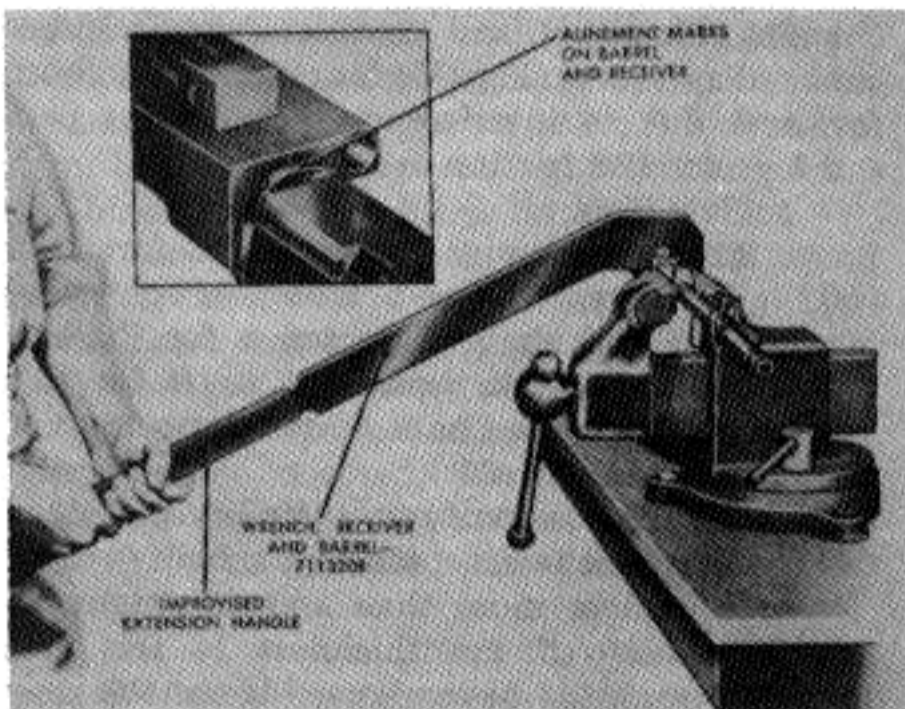

Figure 91. Assembling barrel to receiver.

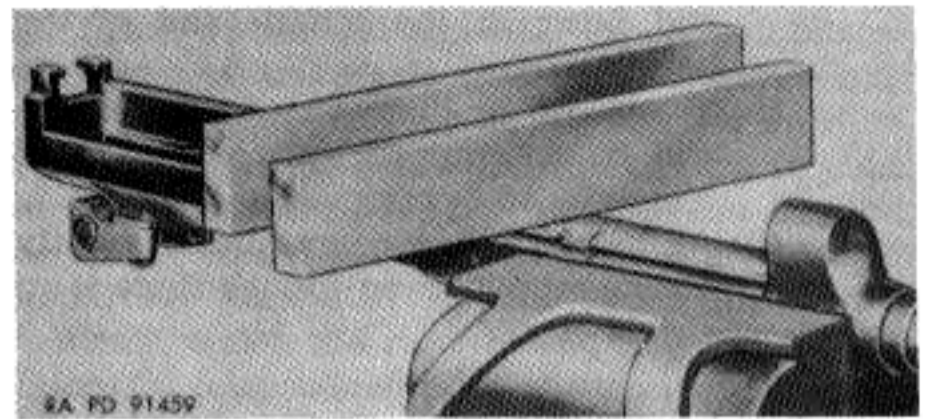

Figure 92. Checking barrel and receiver alignment.

2. Remove the bolt from the carbine and clamp the carbine in the fixture, as indicated in figures 89 and 90.
3. Place a 3/32-inch stamping fixture (Fig. 90). Position and space the stamping fixture by adjusting the stamping guide. Strike the stamping fixture with one firm blow of the hammer to insure a neat and distinct impression. Repeat this procedure until all the digits of the serial number are transposed.

Note. The 3/32-inch stamping fixture is not included in the supply system and must be procured locally.

4. Upon completion of the stamping operation, install the bolt in the receiver and operate through the complete firing cycle to determine whether the receiver has been deformed during the stamping operation.

Note. Under no circumstances will the original serial number be obliterated.

- (e) *Inspection.* All carbines will be inspected to insure that the relocated serial number is a duplicate of the original serial number.

f. *Counterbore Muzzle.*

- (1) The muzzle of all barrels must be counterbored (Fig. 78) during rebuild to remove tool marks, nicks,

and burrs in the muzzle end of the barrel.

- (2) The depth or diameter of counterbore will be determined by the amount of blemishes to be removed.
- (3) All barrels will be counterbored slightly during rebuild, even though there is no visible blemish.

## ASSEMBLY

*a. Replacing Barrel.* Select proper barrel and receiver combination so that about 1/16-inch draw is obtained when assembled. Screw the receiver on the barrel with receiver and barrel wrench 7113308 draw up receiver until alignment marks on barrel and receiver (Fig. 91) coincide. Then determine that the flat surfaces on bottom of barrel and receiver are parallel. Check this by indicator or placing two bars, about 10 inches long, in position as illustrated in figure 92; and sight over the edges. When the two bars lie parallel, the barrel and receiver are in exact alignment for proper functioning.

Note. After installing barrel on receiver, adjust and check the head space as described on pages 82 and 85.

*b. Gas Cylinder Piston and Nut.* Insert gas cylinder piston into cylinder and screw cylinder piston nut into the threads using gas cylinder reconditioning tool 7160995 (Fig. 83) (with component wrench). Make certain to stake the cylinder lightly into the nut, in one of the three places provided, or the nut may work loose during the firing of the carbine. After the piston and nut are assembled in the gas cylinder, check to assure that there is no binding (page 82).

## SECTION X. STOCK GROUP — CARBINES M1, M2, AND M3

### DISASSEMBLY (FIELD OR DEPOT MAINTENANCE)

*a. Front Band Locking Spring* (Figs. 93 and 94). Insert small, straight punch in spring spindle hole in left side of forward end of stock and drive out front band locking spring part way, from left to right; then rotate spring and pull from hole.

*b. Recoil Plate* (Figs. 93 and 94).

- (1) Inscrew recoil plate screw counterclockwise until clear of escutcheon

threads (above 3/4 inch), then withdraw from stock and recoil plate.

- (2) Loosen recoil plate by tapping lightly on rear top face with a metal tool. Pull plate directly forward out of seating recess in stock. Do not pull up or down, because rear seating lug on plate seats in a horizontal recess cut in the stock.
- (3) Do not remove the recoil plate screw escutcheon from the stock except for replacement. To remove, thread recoil plate screw into the escutcheon from the underside until all of the threads of the escutcheon are engaged and pull escutcheon out of stock. If withdrawal is difficult, insert small straight punch from top of screw hole in stock and tap end of screw lightly to loosen escutcheon, or thread screw in from top, part way, and tap lightly; then proceed as above.

*c. Butt Plate* (Figs. 93 and 94). Unscrew butt plate screw counterclockwise and remove from stock. Loosen butt plate by tapping it lightly. Pull to rear off stock. If butt plate is tight, do not pry off, as stock is likely to be damaged. Tap on edges lightly all the way around, until loose enough to pull from stock.

*d. Hand Guard* (Figs. 93, 94, and 96). The liner of the hand guard assembly is riveted to the hand guard; do not remove it.

## INSPECTION

*a. Stock.* Inspect stock for cracks, scoring, chipping, blemishes, and excessive dryness. Inspect cuts and apertures (Fig. 95) for chipping and burrs, for wear due to interference with moving parts, and for excessive friction in assembling.

*b. Butt Plate.*

- (1) Inspect butt plate for deformation, burrs, fit, and looseness on stock. Check butt plate screw for looseness and check threads in stock for stripping. The butt plate screw must fit firmly in stock.
- (2) Protrusion of butt plate beyond edge of stock is acceptable in rebuilt weapons unless more than approximately one-half of the thickness of the metal extends beyond the edge of the stock.

*c. Front Band Locking Spring.* Inspect front band locking spring for deformation and excessive



## M1 CARBINE

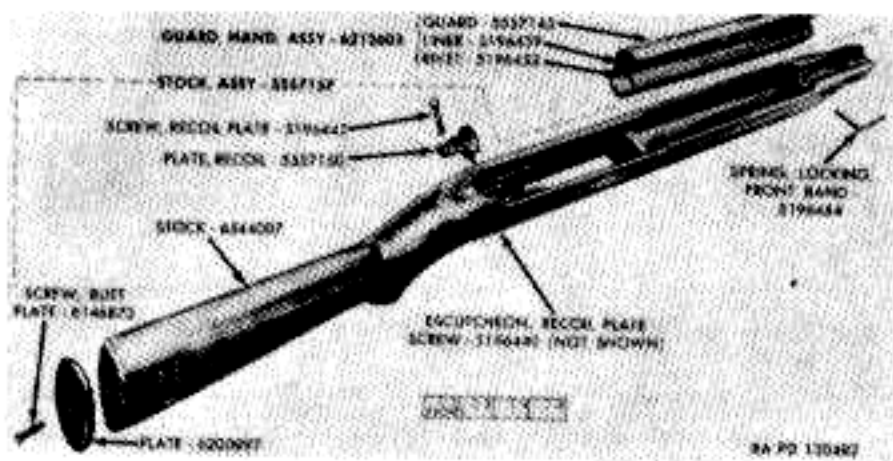

Figure 93. Stock and guard assemblies — carbine M1.

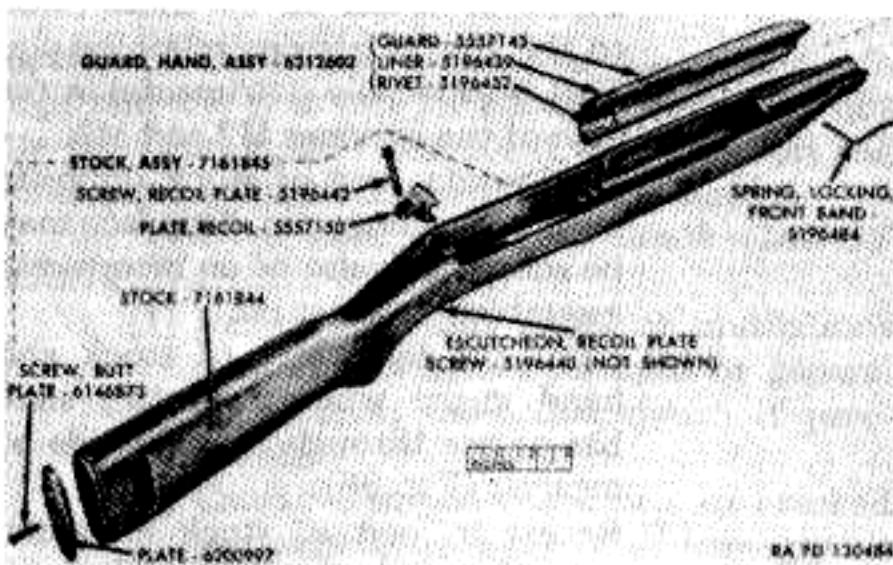

Figure 94. Stock and guard assemblies — carbines M1, M2 and M3.

wear of locking shoulder. Rear face of shoulder should be square enough to retain front band in position.

*d. Clearance Cuts.* Although the same stock is used on carbines M2, M3, and late model M1, for the M2 and M3 examine clearance cut on right for disconnecter and disconnecter lever, and clearance cut on left side for selector (Fig. 97). There must be no binding of either due to undersized cuts.

*e. Recoil Plate.* Check to assure that recoil plate is free from burrs, excessive wear (Fig. 104) and rust, and that it is properly bedded in stock. Where recoil plate is bedded so deeply in stock that it interferes with proper alignment of action, the stock must be rejected. The recoil plate screw escutcheon should not turn in the stock, have burrs, or worn threads. The screw should be tightened firmly.

*f. Fit of Action.* Check fit of action in the stock. Clearance between recoil plate and receiver should not exceed 0.0005 inch when checked with a feeler gage (DEPOT MAINTENANCE ONLY).

See figure 98 for old and new type recoil plates. Both designs are usable if otherwise serviceable. Insert the recoil plate lug on the receiver into the recoil plate. With a slight pressure tending to push the barrel in the stock, rap the butt end sharply; the action should snap into place. The action then should be suspended by the recoil plate with clearance under the receiver and barrel. Test the action for longitudinal play. If such play exists or the action does not lie properly in the stock, a new stock assembly should be selected or the recoil plate replaced in order to meet the above requirements. This is particularly necessary in order to avoid injury to the stock assembly when the spring type recoil plate is used.

*g. Trigger Housing Clearance.* Check to assure that there is at least 0.010-inch clearance between rear end of trigger housing and stock. Use a feeler gage.

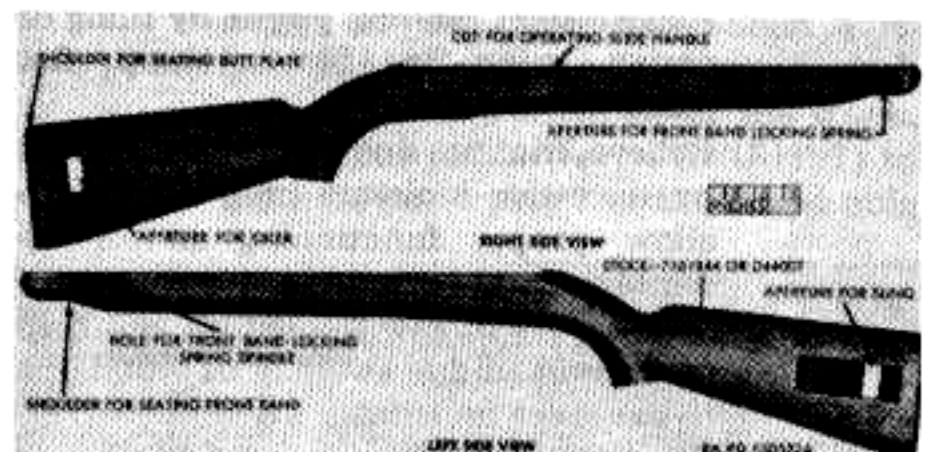

Figure 95. Stock showing apertures — carbine M1.

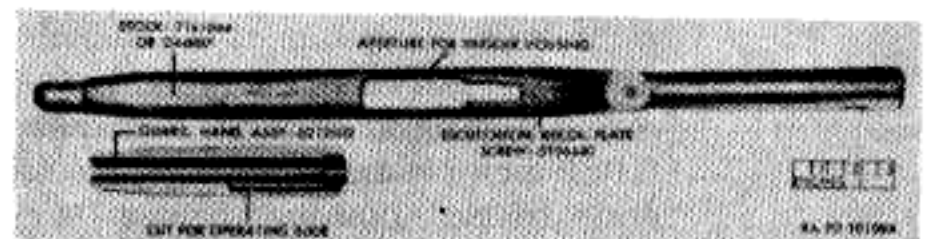

Figure 96. Stock and hand guard — carbine M1.



Figure 97. Stock and hand guard — carbines M1 (late), M2 and M3.

*h. Hand Guard Liner.* Check to assure that liner in hand guard assembly is not distorted and is securely fastened to hand guard. Liners with two rivets or with four rivets, if serviceable, may be used on carbines M1 and M1A1. Only the four-rivet type hand guard assembly 6212602 is to be used on the carbines M2 and M3 (Fig. 99).

*i. Hand Guard.* Check hand guard to assure that front end, which is engaged by front band, is in satisfactory condition. The lengthwise fit of the hand guard should be sufficient to assure adequate engagement with the front band and the hood of the receiver.

*j. Oiler.* Inspect oiler to assure that new type neoprene washer is installed.

## REPAIR AND REBUILD

### *a. Binding of Parts with Stock.*

(1) Binding of moving parts with stock or lack of proper clearance for assembly is evident on the stock by rubbed areas. Relieve such binding points by filing or paring, using fine file or sharp, flat blade.

(2) Relieve friction due to swelling caused by excessive moisture only enough to allow proper functioning and/or assembly, as wood may later dry out and shrink. Use of raw linseed oil will help to prevent undue swelling of wood due to excessive moisture.

(3) Points to check for excessive friction or lack of sufficient clearance are —

(a) Aperture in stock for trigger housing (Figs. 96 and 107). There must be a minimum of 0.010-inch clearance between stock and the rear of the trigger housing. Less than 0.010-inch clearance between stock and trigger housing causes the

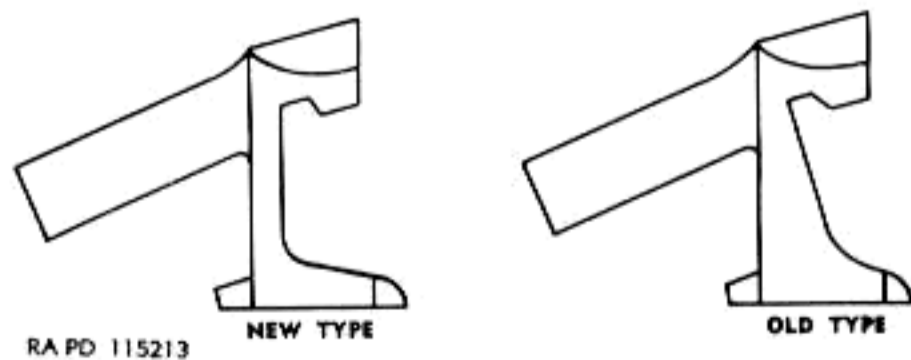

Figure 98. Recoil plate 5557150 — old and new type (both types usable).

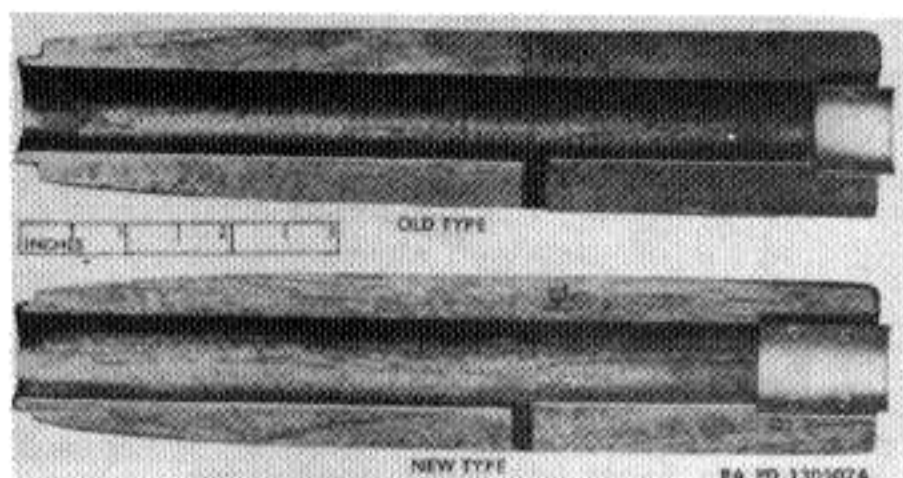

Figure 99. Hand guard assembly 6212602.

shock of recoil to be transmitted to the trigger housing retaining pin. This is especially detrimental in the case of the carbines M2 and M3.

(b) Left inside face of stock opposite head of hammer pin. This face may be scored because of an incorrectly assembled hammer pin.

(c) Point on right side of stock and hand guard where operating slide bar passes through to right side of receiver (Fig. 95).

(d) Recess in bed of stock in which operating slide functions (Figs. 97 and 106).

(e) Forward shoulder of stock and hand guard where front band seats (Figs. 96 and 107).

(f) On the carbines M2 and M3 the left-hand side of stock where selector is located and the right-hand side of stock where disconnecter lever assembly is located (Fig. 97).

*b. Loose Rivets in Hand Guard Liner.* — A hand guard liner (Figs. 93 and 94) indicates improper spreading of the rivets. These rivets are tubular; tighten them by spreading the hollow (inner) ends with a blunt punch. Support the opposite (beaded) end of the rivet while riveting. Place rivet head on a small steel rod or punch clamped in a vise.

*c. Front Band Does Not Seat.* If the front band does not seat properly behind the shoulder of the front band locking spring when assembled, the seating shoulders on stock or hand guard are not cut back far enough or the hand guard liner is too long. To remedy this condition, file the shoulders of stock or hand guard or both at the front sufficiently to allow proper seating and

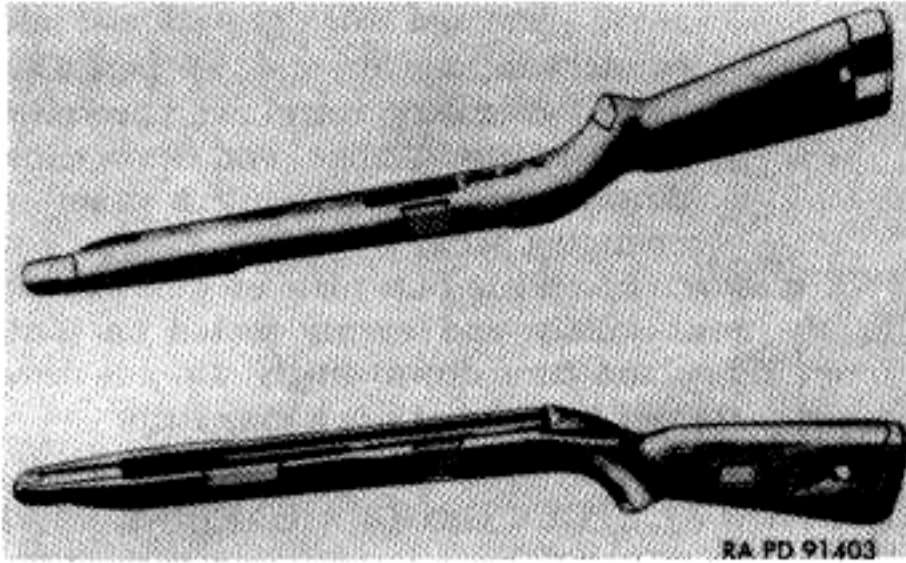

Figure 100. Patched stock.

locking of band. Use a fine flat file with a safe edge and file rear face of shoulder only. Do not file the hand guard liner, for if it is too short the hand guard will fly off when firing the carbine.

*d. Patching and Repairing Stock (DEPOT MAINTENANCE ONLY).*

- (1) *Dents.* Sand out dents or mutilations that do not affect strength or general appearance; use wood dough if practicable.
- (2) *Cracks.* Components which are cracked in such a manner that strength is

affected must be replaced. Where the strength is not affected, use repair screw A233523, or similar screw machined from brass to reinforce weak areas and small cracks. Drill an 0.081-inch hole to receive screw (Fig. 101). Install screw by gripping it in chuck of a hand drill. Cut off screw and file flush with stock so that no edges protrude. Wherever possible dovetail patches in. In figure 100, the light-colored patches show areas that may be patched and the method of inserting them in the stock; the dark-colored patches show areas that cannot be patched without weakening the stock.

- (3) *Stripped thread for butt plate screw.* If the butt plate screw cannot be tightened properly due to stripping of threads in the stock, bore a hole of approximately one-half inch diameter in the stock to a depth approximating length of the screw and obtain a 1/2-inch hardwood plug (hickory or walnut) which is a drive fit in the stock. Apply glue (adhesive — JAN-A-397) to the hardwood plug and the bored hole

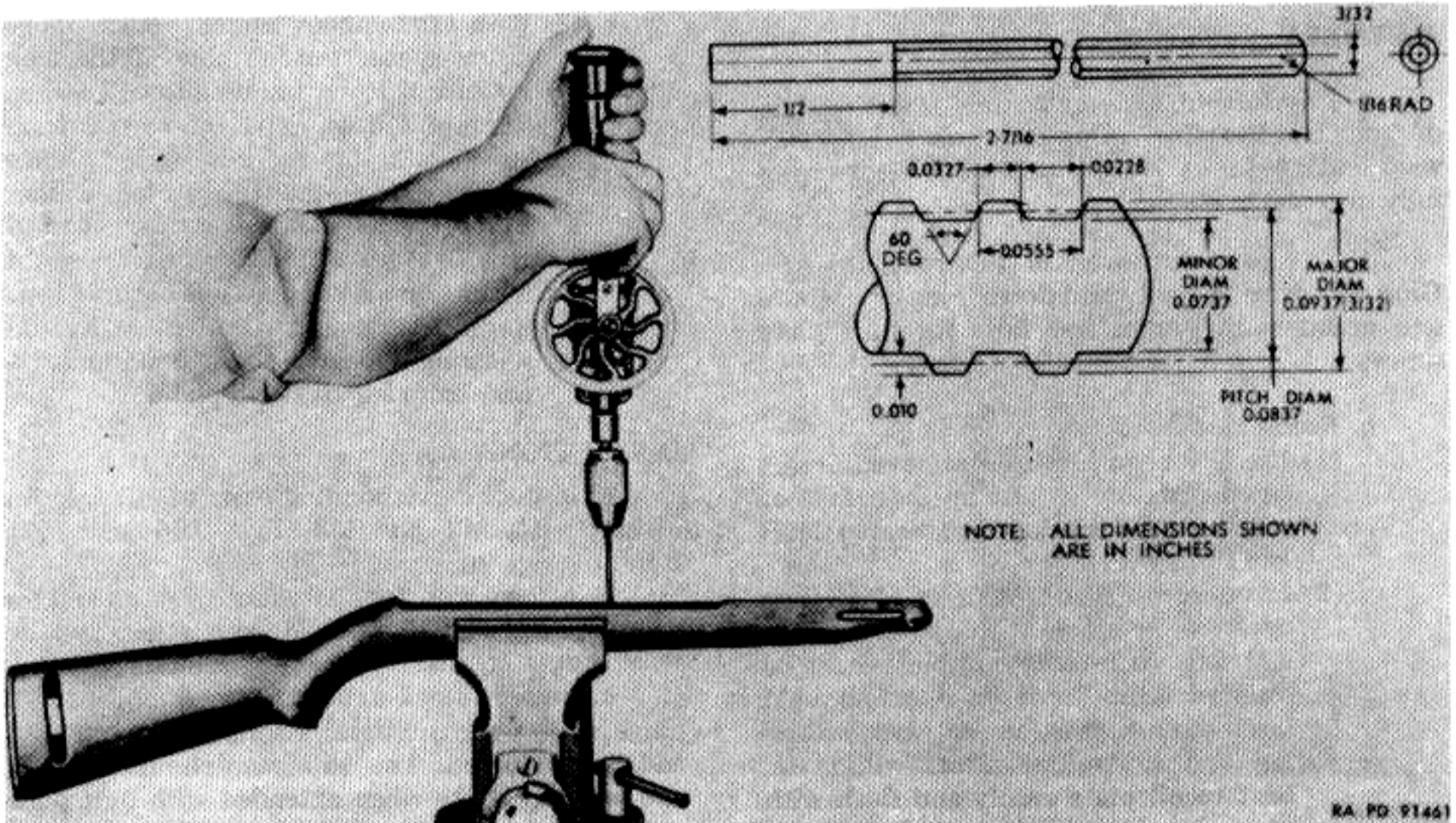

Figure 101. Installing repair screws.

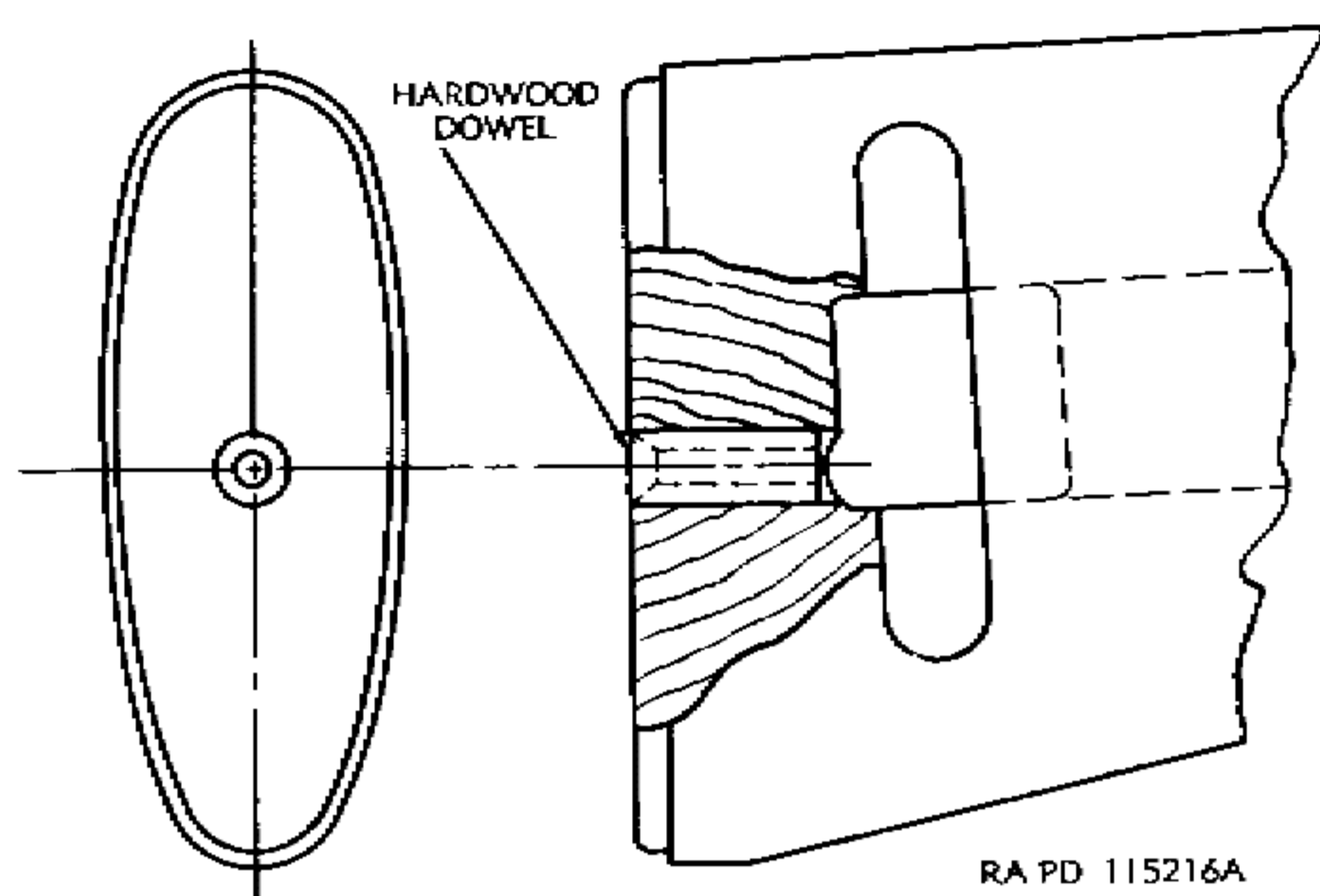

Figure 102. Repair for stripped screw hole.

in the stock. Drive the plug into the bored hole (Fig. 102).

e. *Stock Modification.* Carbine M1 stocks of stock assemblies C57157 of early manufacture were made with a thin section on the right side where the operating slide bar passes to the right side of the receiver. This thin strip should be removed in order to prevent cracks from starting in this area. The stock should be cut down as shown in figure 103.

## ASSEMBLY

a. *Front Band Locking Spring.* Insert spindle of front band locking spring into hole in right forward end of stock and drive to the left. Seat spring fully in recess in stock.

Note. Bore out oversize (approx. 3/8 in.). Glue and drive in hardwood dowel plug and rebore and countersink proper size hole for butt plate screw.

### b. Recoil Plate.

- (1) If escutcheon has been removed, insert small end first in seat in lower face of stock grip. Tap in until seated level and flush with stock.
- (2) Insert recoil plate into rear of receiver aperture in stock with bevel face up and tang to rear. Recoil plate must be inserted from front to rear and held level during insertion, so that seating lug and horizontal recess will mate. Seat recoil plate evenly and flush with recess in stock by tapping lightly. Install recoil plate screw through top of

recoil plate and stock grip, thread into escutcheon, and draw down part way. Then assemble barrel and receiver group to stock, align, and draw screw down tight. This prevents a strain on operating parts.

c. *Butt Plate.* Plate butt plate on butt and tap lightly until solidly and evenly seated on butt. Insert screw and turn down snugly. Do not force screw as threads in wood of stock may strip.

## SECTION XI. STOCK GROUP — CARBINE M1A1

### DISASSEMBLY (FIELD OR DEPOT MAINTENANCE)

#### a. Stock Extension (Fig. 105).

- (1) Remove lower hinge screw from lower end of stock grip by turning counterclockwise.
- (2) With stock extension in extended position, unscrew the hinger screw projecting from the upper face of the recoil plate cap by turning counterclockwise. When screw is disengaged from the lower hinger nut, pull screw up and out of grip and then lift off recoil plate cap and lower hinge.
- (3) With flat-ended punch, push hinge screw spacer out of hole in the lock on end of lower bar up into coil spring. Then pull stock extension to rear from stock and remove grip spring, hinge screw spacer and trip spring washer from countersunk hole in lower end of grip. Take care that spring does not fly out or washer does not become lost.
- (4) Remove grip and recoil plate by unscrewing the grip screw counterclockwise from top of recoil plate.

## INSPECTION

a. Inspect corresponding parts of stock as for carbines M1, M2, and M3 (Figs. 106 and 107). Refer to page 90.

b. Inspect grip for looseness on stock and for cracks. Grip should be rigid with stock and no twist should be possible when assembled.

c. Inspect stock extension for smoothness of hinge action and positive locking when extended and when folded. The extension should be rigid and without shake when extended with butt plate rigidly at right angles to the bars. When swung to the left, the lock should cam out of the slot

# M1 CARBINE

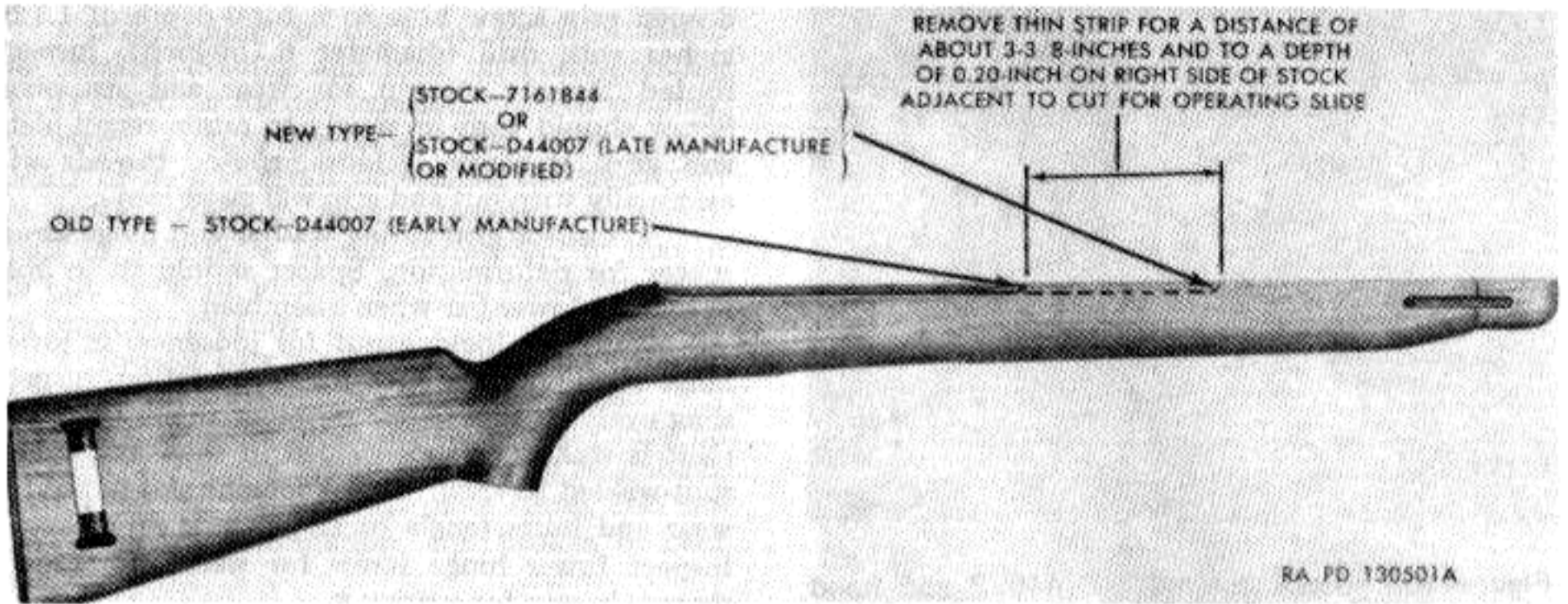

Figure 103. Modification of stock D44007 of early manufacture (carbine M1).

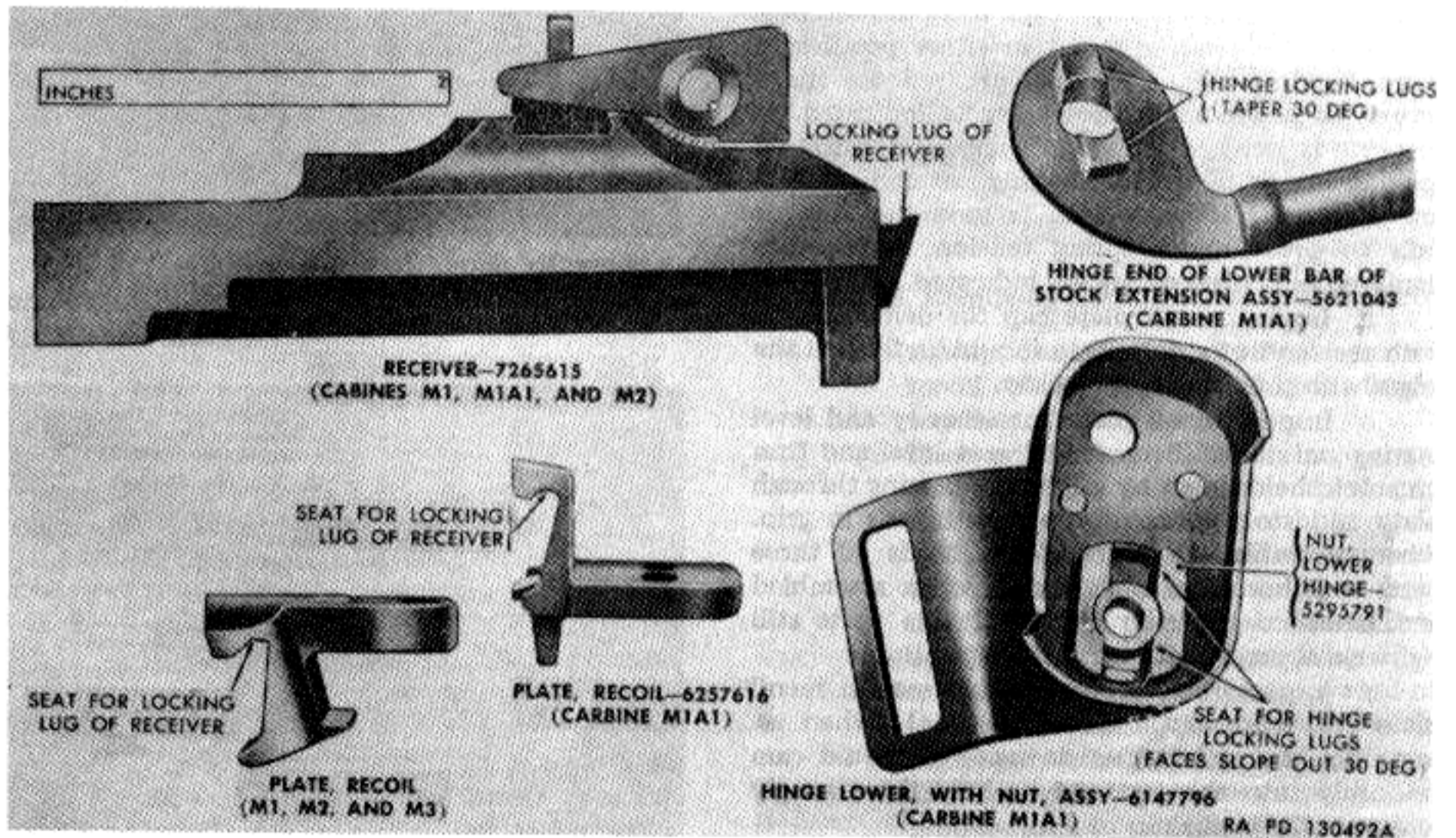

Figure 104. Important wearing surfaces.

## M1 CARBINE

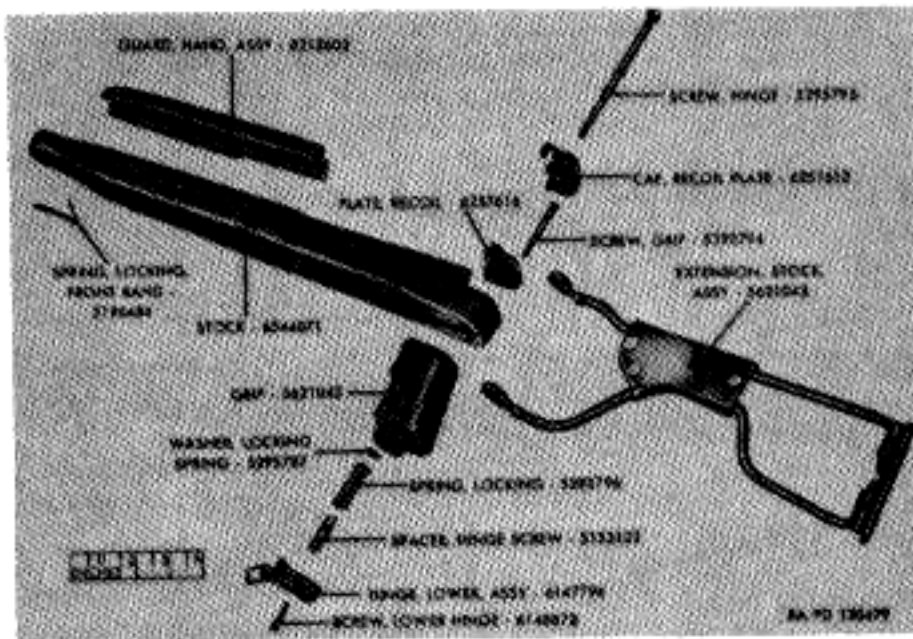

Figure 105. Stock assembly 6544072 and hand guard assembly 6212602 for carbine M1A1.

in the locking nut, and the extension should pivot smoothly about the hinge screw through an arc of approximately 180 degrees to lie flat against the left side of the stock. When the extension is pressed flat to the stock, the lock should slip into the slot in the locking nut and the butt plate should pivot on the bar ends, so that the extension will lie locked close to the stock without looseness or shake. If shake is present in either position, a worn locking lug or locking nut, a loose hinge screw, or a broken hinge spring is indicated. If pivoting is jerky, or binding is apparent, burrs on locking lug or in slot of locking nut or bent bars are indicated. If butt plate is loose on bars or fails to pivot under spring tension, burrs or a damaged butt plate spring are indicated.

d. Inspect recoil plate cap for dents and fit with rear end of stock. Plate should lie flush at the edges with the stock and receiver.

e. Inspect recoil plate for security and level seating on stock. Plate should seat level and firm on stock, held down by grip screw passing through plate and stock and into routed threads in grip. When assembled, the grip screw holds all three parts together. The hinge screw, when assembled and threaded into the nut, binds the parts still tighter and prevents the grip from twisting.

f. Inspect receiver locking lug seat in recoil plate for wear and burrs (Fig. 104). When assembling, the locking lug on receiver should cam smoothly into the seat and be held there snugly without play or shake.

g. Inspect grip screw for length and burred threads. Replace the 2 3/32-inch grip screw by a 2 3/4-inch screw. If screw has not been replaced,

deepen grip screw hole to a total depth of 1.125 inches with drill (diameter 0.159-inch). Inspect routed threads in grip for wear and stripping. Screw should turn in snugly to retain recoil plate and grip. If screw is loose, routed threads will eventually strip out and grip will twist loose.

h. Inspect grip spring washer and hinge screw spacer for deformation. Spacer should fit in hole in lock on lower bar when assembled.

i. Inspect locking nut for looseness in lower hinge shell. Inspect shell for deformation. Inspect sling eyelet for looseness on hinge shell (Fig. 104). (Nut is staked or spot-welded in shell and eyelet spot-welded to shell.) Check locking slot in nut for wear and burrs (angle of slot face is 30 degrees). Inspect lower hinge screw for wear and inspect threads in grip for stripping.

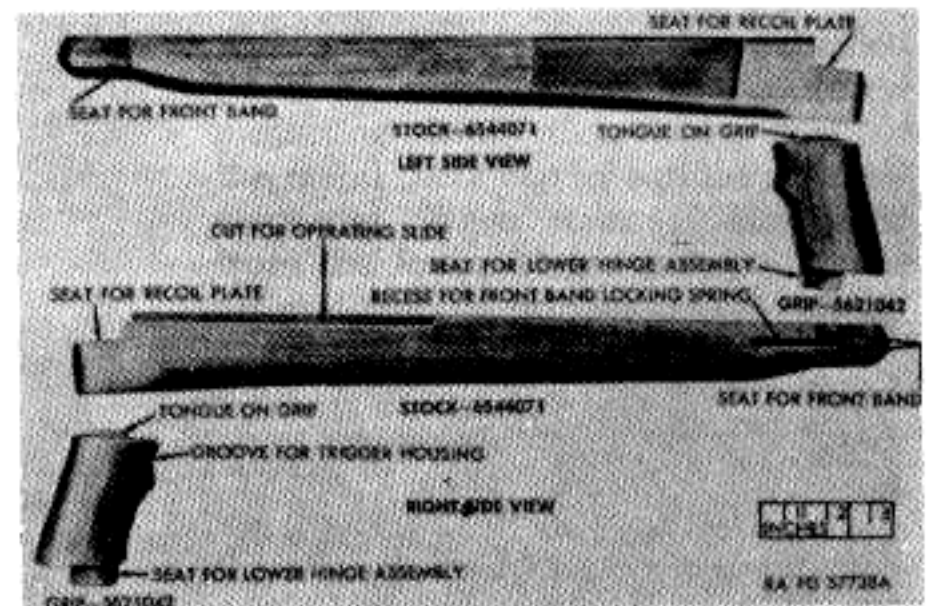

Figure 106. Stock and grip for carbine M1A1.

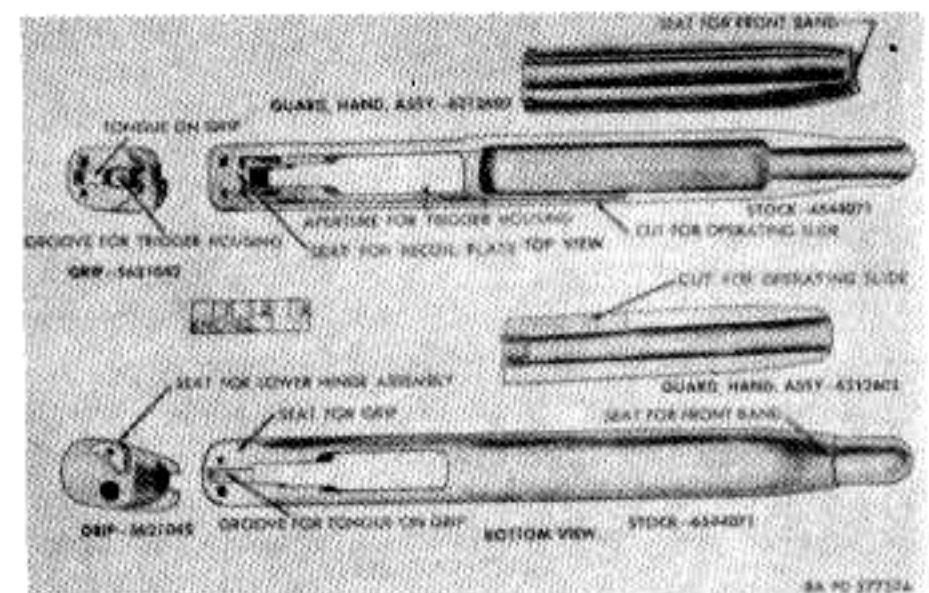

Figure 107. Stock, hand guard and grip for carbine M1A1.

*j.* Inspect hinge on upper bar for deformation and cracked welding and lock on corresponding end of lower bar for deformation, cracked welding, and worn locking lug (Fig. 104). The proper mating of lock and nut determine the rigidity of the stock extension when extended or folded. Angle of lock faces should correspond to that of the nut. Wear of lock or nut will cause looseness and improper locking.

*k.* Inspect bars for deformation. They should lie in the same vertical plane when assembled.

*l.* Inspect butt plate for smooth pivoting on rod ends, for spring action with spring assembled, and for cracks. Inspect butt plate spring for tension, excessive deformation, and broken or bent ends.

*m.* Inspect cheek rest plate and retaining plate for deformation and looseness with each other on the bars when assembled. Inspect rivets for looseness and protrusion of heads. Inspect cheek rest cover for scoring and cracking of leather. Cheek rest plate should be held tightly to bars by retaining plate and rivets, and leather cover, on the stock extension assembly (Fig. 105), should be smooth, so it will not scrape face of operator.

#### REPAIR AND REBUILD (FIELD AND DEPOT MAINTENANCE)

*a.* When the stock for the M1A1 carbine is irreparable or unavailable, it is to be replaced by the standard type stock assembly for the carbine M1.

*b.* For maintenance and repair of wooden components, see page 92 covering the carbines M1, M2 and M3.

#### ASSEMBLY

*a. Stock.* For items that correspond to the carbines M1, M2 and M3, see page 94.

*b. Stock Extension.*

- (1) If the grip and recoil plate have been removed, replace them by fitting grip to rear, under face of stock, just behind trigger guard opening so that projection on grip points downward and trigger guard bow will fit into forward face of grip when assembled. Seat the recoil plate on top of rear end of stock with undercut lug facing forward. Align screw holes in plate and stock, insert grip screw and screw down

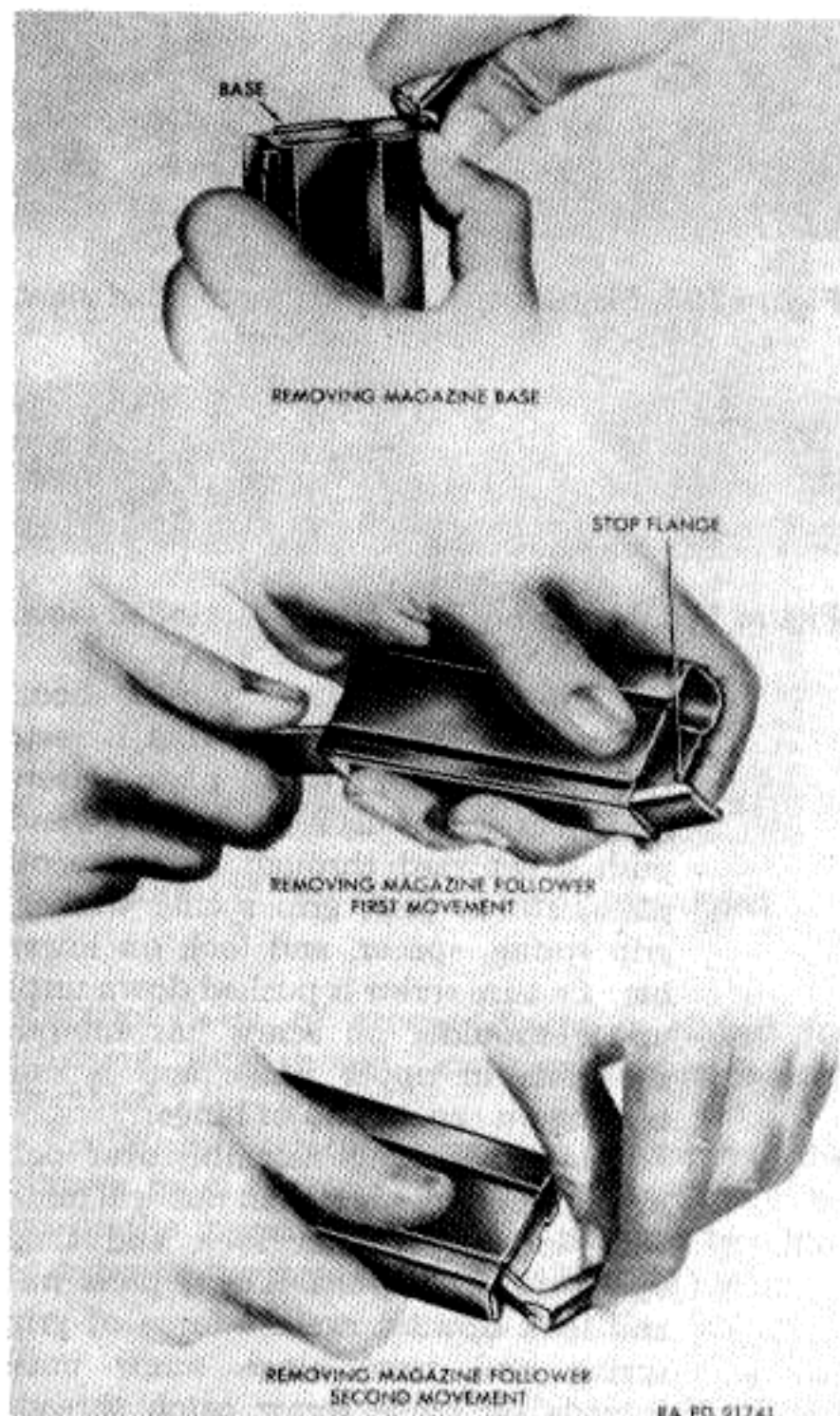

Figure 108. Removing magazine base and follower.

tightly, turning clockwise to secure recoil plate, stock, and grip firmly together.

- (2) Place grip spring washer in large counterbored hole in lower end of grip and seat grip spring in hole upon washer. Then grasp stock extension so that locking lug on lower bar faces downward and place upper face of lock against lower end of grip spring. Hold in position firmly and press upward on lock against spring pressure until hinge on upper (straight) bar will slip over and lie upon top of recoil plate. Still holding lock in position with regard to spring, align hole in spring and lock, and insert hinge screw spacer until flush with lower face of lock.



## VI. Final Inspection

### GENERAL

Weapons turned in for repair may be assumed to have defects caused by use or neglect. When they were accepted as new weapons, the parts composing them were dimensionally correct and made of the proper material. Consequently, the inspection of these weapons after repair will differ from the inspection procedure used in the manufacturing plant in that attention will be directed to wearing surfaces, parts that might crack or break due to high stress or fatigue, and evidence of corrosion. These defects do not evidence themselves by uniform reduction in a given dimension but show up as a chipped edge, a partially worn surface, or an eccentric hole. A gage used in manufacturing is merely means of comparing an unknown dimension with a known one to judge whether a piece comes within tolerances. After a piece is worn through use, the change in dimension is more easily detected in many cases by comparing with adjacent surfaces; the piece in itself becomes a gage. Visual inspection, therefore, is far more applicable in these cases and gaging is limited to those dimensions that are critical and that may be advantageously measured rather than compared. Inspection of noncritical parts (parts that do not cause malfunctions) is limited to appearance and the presence of cracks or flaws. The dimensions placed on these parts (and gaging used during manufacturing) were for the sole purpose of insuring interchangeability. Even if the dimension of such parts are worn considerably below drawing tolerances, functioning and interchangeability will not be adversely affected and the parts are consequently acceptable.

### INSPECTION GUIDE

Table II is a check list for inspection of the carbines in the hands of troops and is applicable to check points of inspection for return to user and for return to stock.

### RETURN TO USER

a. Carbines are not to be considered unsuitable for oversea use because of lack of modification unless such modification affects the safety of personnel, is essential to the functioning of the weapon, or is prescribed by an URGENT modification work order.

b. Newly manufactured and issued materiel, which has been inspected and accepted in accordance with Department of the Army specifications, is not to be rejected except for well-grounded reasons. All such rejections must be reported immediately to higher authority.

c. Satisfactory metal finishes for weapons range from dense black to medium light gray. Certain small-arms weapons are manufactured with an unusual shade of neutral gray finish. Since this finish (gray zinc phosphate) is an accepted Department of the Army standard, these weapons are not to be rejected by inspectors or troops for this condition. A worn surface is objectionable from the standpoint of visibility when it is capable of reflecting light, somewhat as a mirror does. No weapon is to be rejected for oversea use unless exterior parts have a distinct shine. Bright rear sights must not be permitted on weapons for oversea use. Check to see that all rear



## M1 CARBINE

sights have a dull black or gray finish on all surfaces.

d. Wooden components must not be cracked in such a way as to interfere with their structural strength. Surface cracks, bruises, or dents which do not affect their strength should not cause rejection.

e. Inspection of the barrel to determine that it meets the requirements for return to user is similar to the inspection of the barrel required for return to stock which is described in TB ORD 366.

f. Looseness and play in such components as the sight, gas cylinder, recoil plate, bolt, may be cause for rejection. In many cases, however, the importance of such defects is exaggerated. Looseness and play must be considerable to affect the accuracy of a weapon beyond its natural dispersion. All weapons, especially those that are automatic, must have play between working components to permit them to operate in localities where sand and dust are prevalent. A weapon may be completely useless if its working parts are fitted with insufficient clearance.

g. Minor defects in metal components do not normally affect their being acceptable. Scratches and tool marks on barrels are ordinarily of no importance.

h. Inspect the functioning and operation of components as described.

i. Check to see that serial number on receiver is plainly visible.

### ADDENDUM TARGETING REQUIREMENTS

*25-yard range targeting diagram for carbines,  
cal. .30, M1, M1A1, and M2.*

Note. It should be understood that in processing inspection (as distinguished from final inspection), the adjustment of windage is accomplished by

moving the rear sight base in the receiver, as necessary, and the elevation is adjusted by the height of the front sight blade. In order that the above requirements be met, it is advisable to adjust the sights as closely as practicable to the place where the carbine is shooting. To do this, adjust position of rear sight in receiver and height of front sight blade.

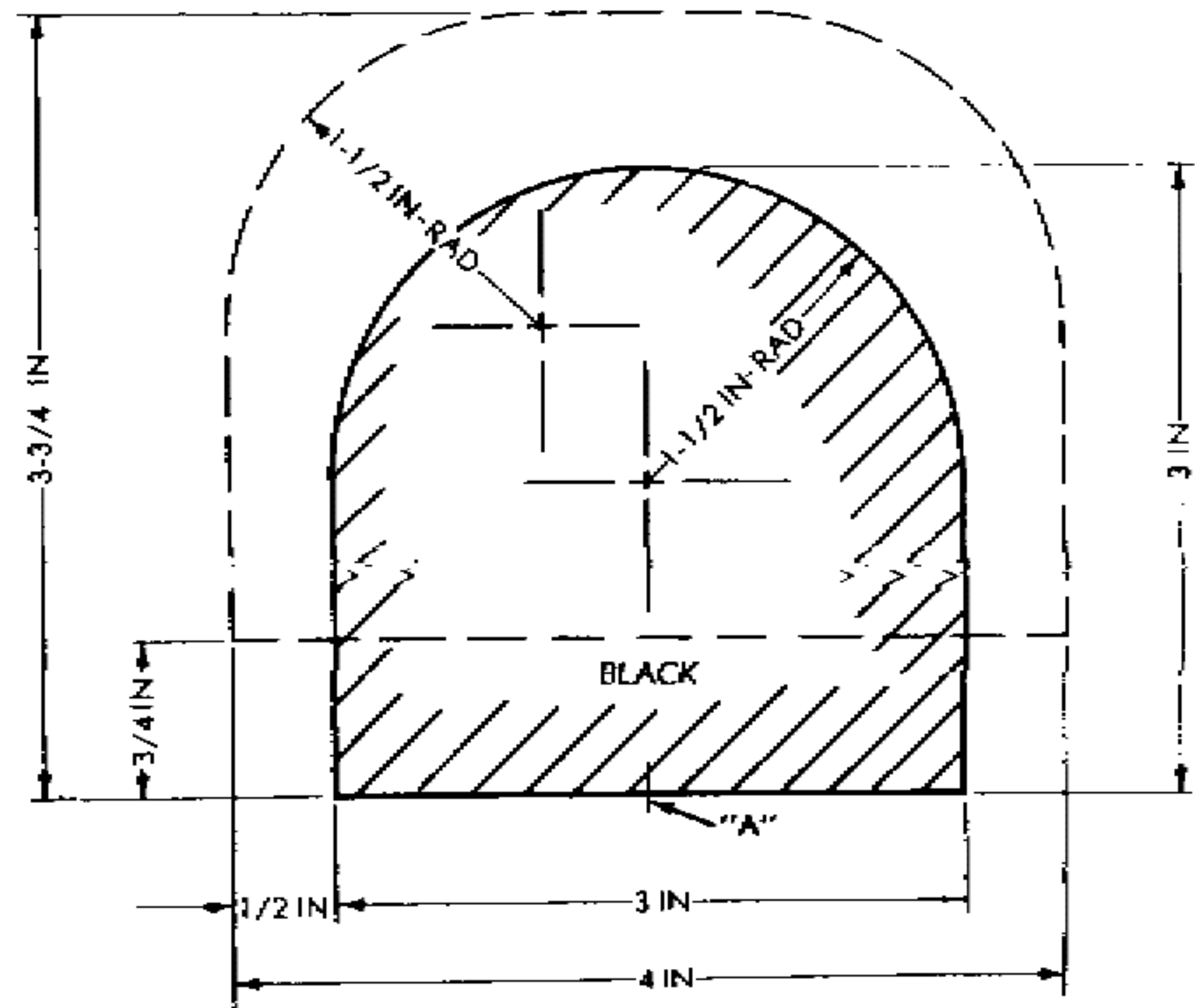

### TARGETING REQUIREMENTS:

A PROPERLY TARGETED CARBINE HELD SO THAT THE TOP OF THE FRONT SIGHT BLADE IS CENTERED ON POINT "A", WITH REAR SIGHT SET AT ZERO WINDAGE AND 100 YD. ELEVATION, WILL SHOOT A GROUP OF FIVE OUT OF SEVEN CONSECUTIVE SHOTS WITHIN OR CUTTING THE DOTTED LINE.

NOTE: GRID LINES REPRESENTING 1 MINUTE OF ANGLE MAY BE ADDED TO TARGET TO FACILITATE MEASUREMENT.